

R1973 SERIES ROCKER SWITCH

ANTI-VANDAL SWITCHES
 DETECTOR SWITCHES
 DIP SWITCHES
 KEYLOCK SWITCHES
 NAVIGATION SWITCHES
 PUSHBUTTON SWITCHES
ROCKER SWITCHES
 ROTARY SWITCHES
 SLIDE SWITCHES
 SNAP ACTION SWITCHES
 TACTILE SWITCHES
 TOGGLE SWITCHES
 CAP OPTIONS



APPLICATIONS / MARKETS



Home Appliances

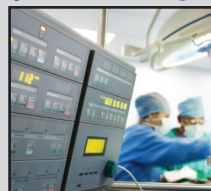

Medical Equipment



Electrical Houseware

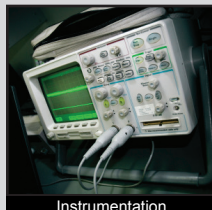

Instrumentation

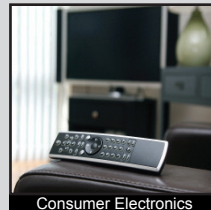

Consumer Electronics

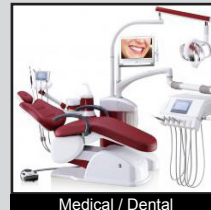

Medical / Dental

RoHS

SPECIFICATIONS

Contact Rating: 9A @ 125VAC [cURus]
 6A @ 250VAC [cURus]
 4A(1) @ 250VAC [VDE]
Contact Arrangement: SPST, DPST
Electrical Life: 10,000 cycles
Mechanical Life: 30,000 cycles
Insulation Resistance: >1000 MΩ
Dielectric Strength: >1,500VAC for 1 minute
Operating Temperature: -30°C to 65°C
Storage Temperature: -30°C to 80°C
Panel Thickness: 0.7mm to 3.0mm

FEATURES & BENEFITS

- Agency approvals: cURus, VDE
- SPST and DPST
- Illumination options
- Multiple termination options
- Actuator marking available
- Standard 13mm x 19mm panel cutout size

PART NUMBER CONFIGURATOR

Series	Circuit	Housing Color	Actuator Color	Marking (see chart)	Termination	Lamp Voltage
<input type="text" value="R"/> <input type="text" value="1"/> <input type="text" value="9"/> <input type="text" value="7"/> <input type="text" value="3"/>	<input type="text" value="A"/> <input type="text" value="B"/>	<input type="text" value="BLK"/> <input type="text" value="WHT"/> <input type="text" value="GRY"/>	<input type="text" value="BLK"/> <input type="text" value="RED"/> <input type="text" value="GRY"/> <input type="text" value="YIL"/> <input type="text" value="GIL"/> <input type="text" value="RIL"/> <input type="text" value="BIL"/>	<input type="text" value="A"/> <input type="text" value="D"/> <input type="text" value="E"/> <input type="text" value="F"/> <input type="text" value="G"/> <input type="text" value="I"/>	<input type="text" value="F"/> <input type="text" value="R"/>	<input type="text" value="0"/> <input type="text" value="1"/> <input type="text" value="2"/> <input type="text" value="3"/> <input type="text" value="4"/> <input type="text" value="6"/>
R1973	A - SPST B - DPST	BLK - Black WHT - White GRY - Grey	BLK - Black RED - Red GRY - Grey YIL - Yellow Illuminated GIL - Green Illuminated RIL - Red Illuminated BIL - Blue Illuminated		F - Faston R - Right Angle PC Pin	0 - No Lamp 1 - Neon Bulb 125V-AC 2 - Neon Bulb 250V-AC 3 - Incandescent Bulb 12V-DC 4 - Incandescent Bulb 24V-DC 6 - Incandescent Bulb 6V-DC

Specifications subject to change without notice 2.16.2018



E-SWITCH®

www.e-switch.com

800.867.2717

1

R1973 SERIES ROCKER SWITCH

BODY DIMENSIONS

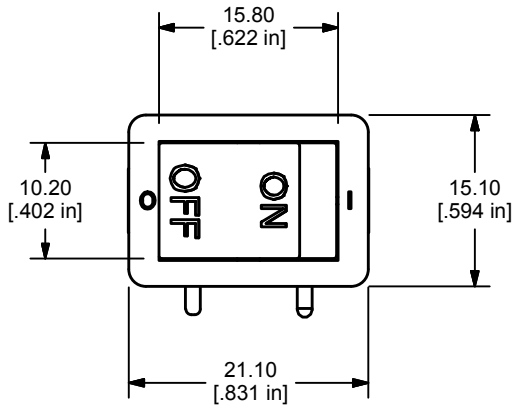

MODEL NO.	POS. 1	POS. 2
A - SPST	OFF	ON
TERMINAL CLOSURE	OPEN	1-1a or 2-2a for NON-ILLUMINATED RIGHT ANGLE PC PIN

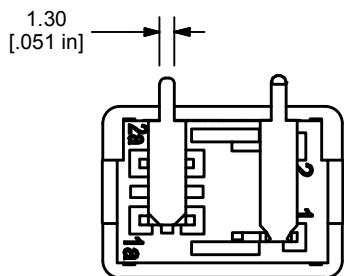
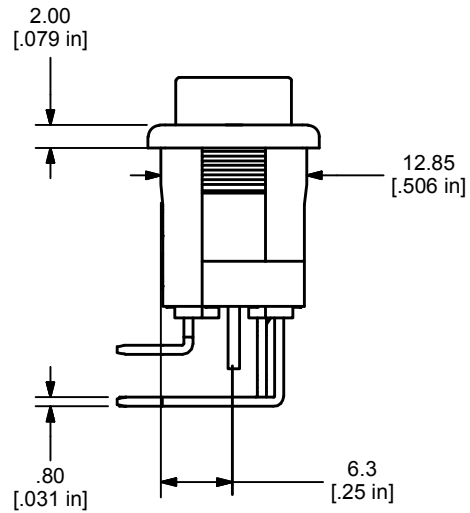
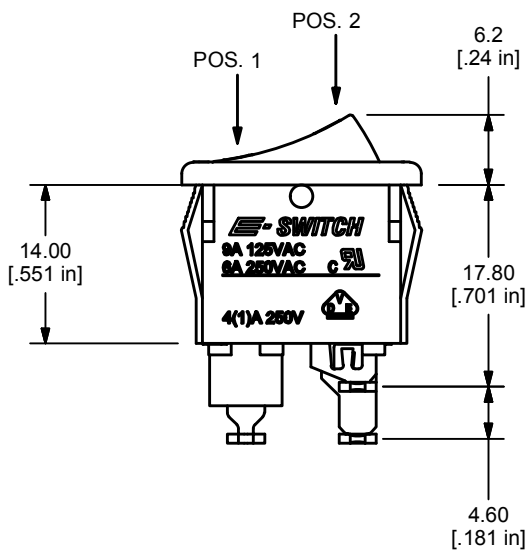

"R" TERMINAL
(RIGHT ANGLE TERMINALS BENT
TOWARDS THE LOGO SIDE)

SHOWN WITH
A - SPST ILLUMINATED
I - MARKING
R - RIGHT ANGLE PC PIN

- ANTI-VANDAL SWITCHES
- DETECTOR SWITCHES
- DIP SWITCHES
- KEYLOCK SWITCHES
- NAVIGATION SWITCHES
- PUSHBUTTON SWITCHES
- ROCKER SWITCHES**
- ROTARY SWITCHES
- SLIDE SWITCHES
- SNAP ACTION SWITCHES
- TACTILE SWITCHES
- TOGGLE SWITCHES
- CAP OPTIONS



R1973 SERIES ROCKER SWITCH

BODY DIMENSIONS

- ANTI-VANDAL SWITCHES
- DETECTOR SWITCHES
- DIP SWITCHES
- KEYLOCK SWITCHES
- NAVIGATION SWITCHES
- PUSHBUTTON SWITCHES
- ROCKER SWITCHES**
- ROTARY SWITCHES
- SLIDE SWITCHES
- SNAP ACTION SWITCHES
- TACTILE SWITCHES
- TOGGLE SWITCHES
- CAP OPTIONS

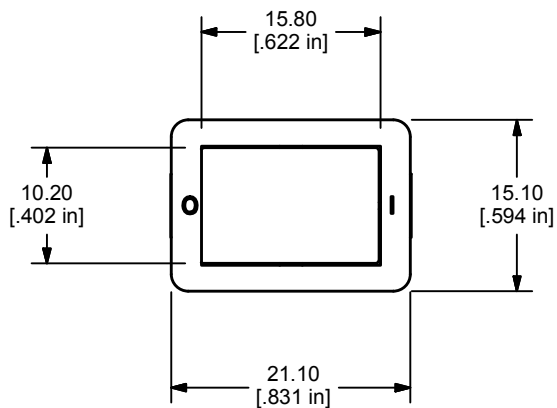

MODEL NO.	POS. 1	POS. 2
B - DPST	OFF	ON
TERMINAL CLOSURE	OPEN	1-1a, 2-2a

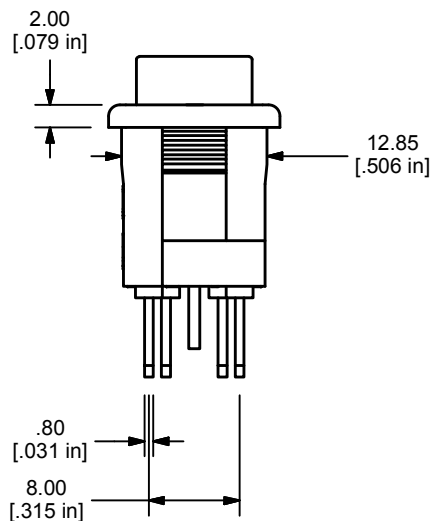
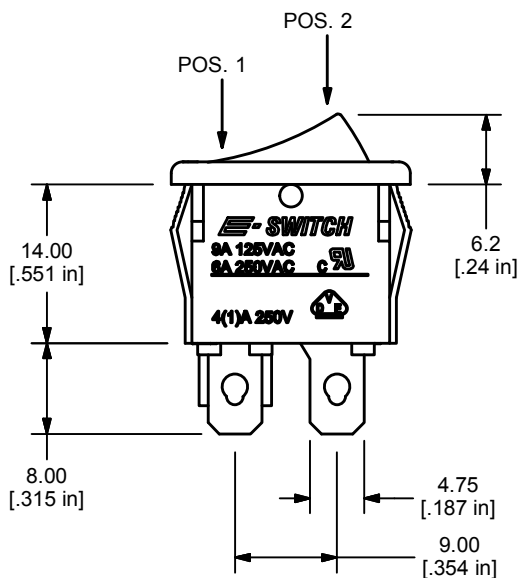

TERMINAL DESIGNATIONS (DPST VERSION SHOWN)

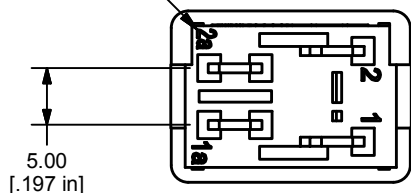

SHOWN WITH
B - DPST
E - MARKING
F - FASTON



R1973 SERIES ROCKER SWITCH

MARKING OPTIONS

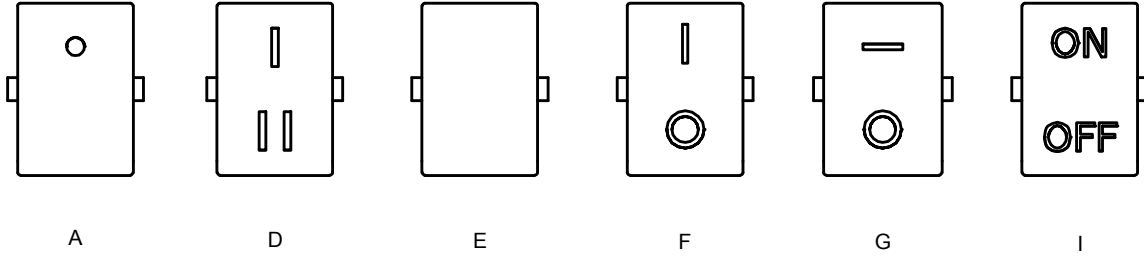

PCB LAYOUTS

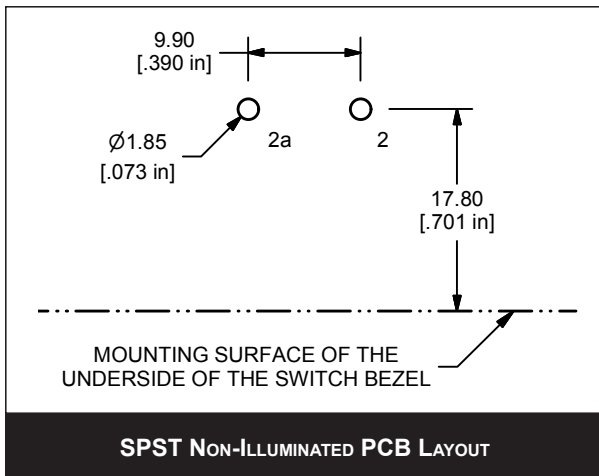
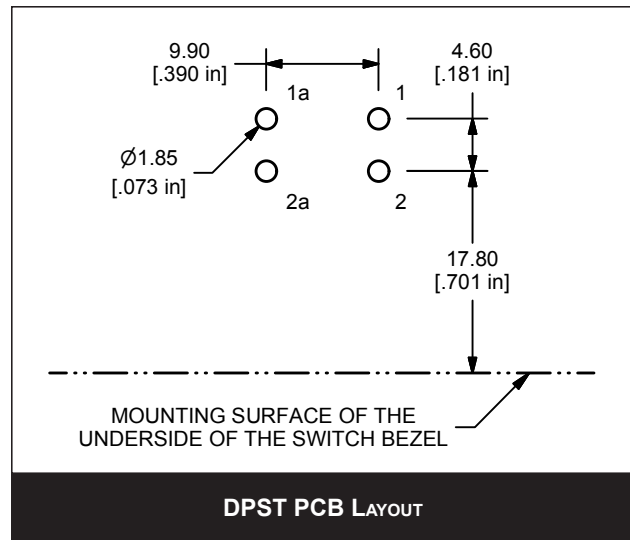
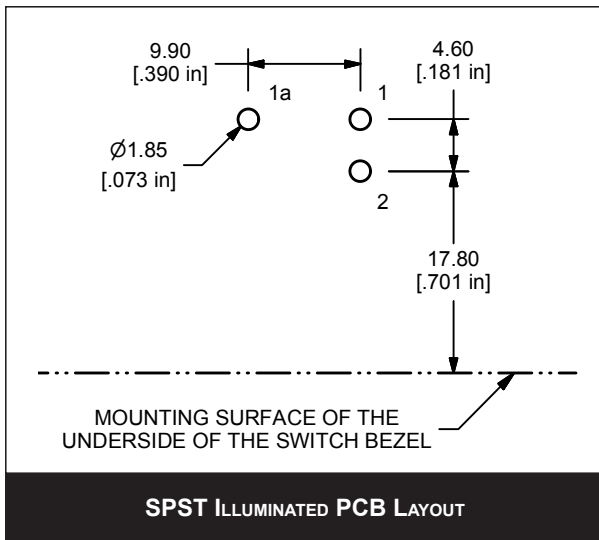

R1973 SERIES ROCKER SWITCH

SCHEMATICS

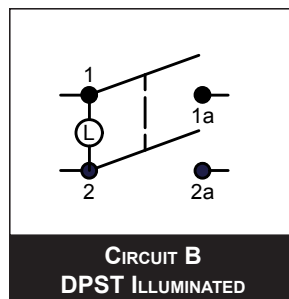
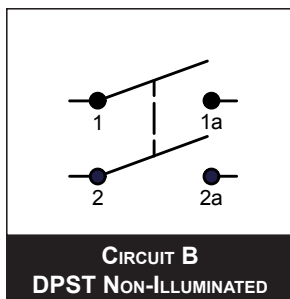
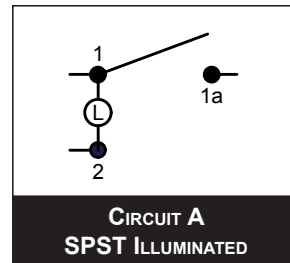
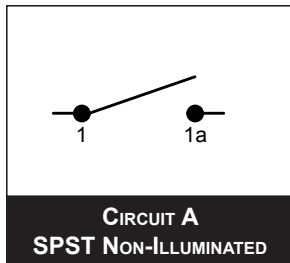
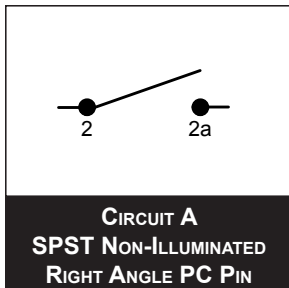

PANEL CUTOUT

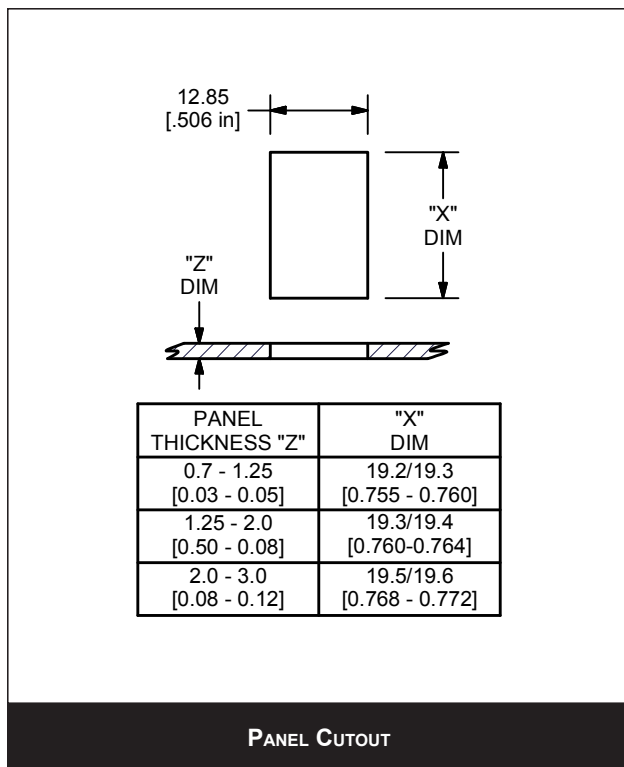

X-ON Electronics

Largest Supplier of Electrical and Electronic Components

Click to view similar products for [Rocker Switches](#) category:

Click to view products by [E-Switch](#) manufacturer:

Other Similar products are found below :

[LTI LA6E-1S-WH-RC-FN12VXCR1](#) [6-1571986-9](#) [8007K26N324V52](#) [8055K32Z7V](#) [8055K52Z7V](#) [8138K20E6M50](#) [84206L](#) [84312LX](#)
[PREDD5-07F-BB0GW](#) [999-16716-002](#) [999-16716-003](#) [999-16716-004](#) [A101J1V3Q004](#) [A101J2ZQ004](#) [A101J4ZQ004](#) [A101J51CB0004](#)
[A103J1ZQ004](#) [A201J1AQ004](#) [A201J3ZB004](#) [A201J50ZQ004](#) [A203J51ZQ0004](#) [A435S1YZQ](#) [H8500XBBBBL-A](#) [H8653VBBG2577W](#)
[HB130CHNWWNAAC](#) [R13112ABB-602W](#) [1251.0303](#) [AE205J60V3B004](#) [1352.0107](#) [1500G51E](#) [1571099-3](#) [1571987-4](#) [1571987-5](#)
[1571989-7](#) [1571988-5](#) [B123J77V7B2](#) [B226J50W4Q22P](#) [B433J37ZQ22M](#) [160212E](#) [1634200-7](#) [1801.1164](#) [1839.1502](#) [PANEL-PLUG-VHP-](#)
[BLACK](#) [PANEL-PLUG-VHP-WT](#) [K1ABBSCADN](#) [K2ABAAAAAA](#) [KG312A2DXD246X](#) [250011E714](#) [2600HM11E](#) [2600R21E](#)