

ROCKER

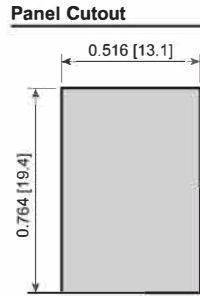

Actuator Options

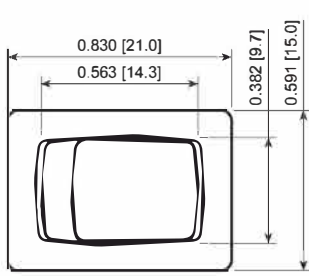
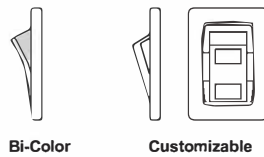

Terminal Options

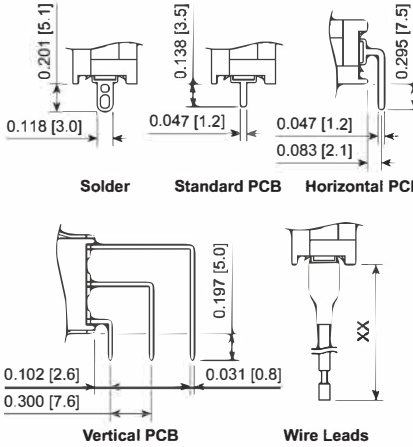

FEATURES:

- High Rating
- Snap in with Multiple terminal options
- Many Functions Available
- PVC Cap for Dust and Water Protection

SPECIFICATIONS:

RATING: *RATING OPTION C:*
16A 125VAC [cULus]

Rating Option 3:
11A 125VAC [cULus]
5.5A 250VAC [cULus]

Ratings of Illuminated Switches May Vary

TEMPERATURE: -20°C to 55°C
ELECTRICAL LIFE: 10,000 Cycles
CONTACT RESISTANCE: 30mΩ Max.
INSULATION RESISTANCE: 500MΩ Min. at 500VDC
DIELECTRIC STRENGTH: 1,000VAC for 1 Minute
INGRESS PROTECTION: IP54 with PVC Cap

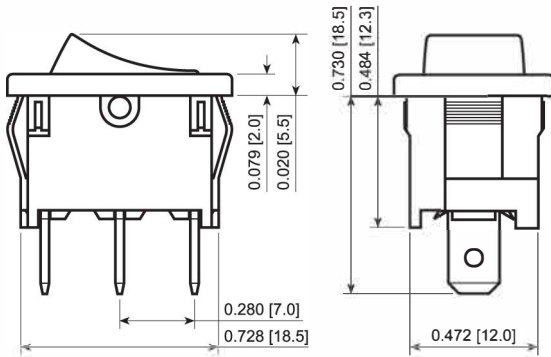

Water Protection Option

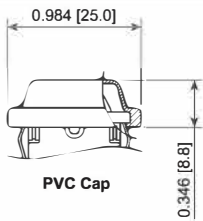

Illumination Options

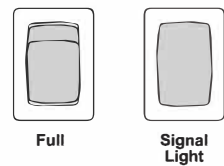

Dimensions of Illuminated Switches May Vary From Above

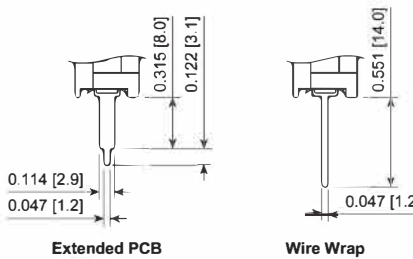

RA111C1A00



RA111C1021-116



RA111C1213

RA113C1100
ACC-P01

Series	Terminal	Function	Rating	Body Color	Actuator Color	Marking Color	Marking Type	Lens Style	Lens Color	Lamp Voltage
RA1 - Curved Actuator RA1C - Customizable Actuator	0 - Blank 1 - 4.8mm Tab (*) 2 - Solder (*) 3 - PCB Pin H - Horiz. PCB V - Vert. PCB A14 - Wire Wrap E08 - Ext. PCB Wxx - Wire Leads (xx in Inches)	0 - Signal / Blank 1 - Off-On (*) 3 - On-On 4 - Off-(On) 5 - On-Off-On A - On-(Off) C - On-Off-(On) D - (On)-Off-(On)	0 - Signal / Blank 3 - 11A 125V C - 16A 125V	1 - Black 2 - White 3 - Almond 4 - Grey 9 - Red	0 - Illuminated 1 - Black 2 - White 3 - Almond 4 - Grey 5 - Orange 7 - Blue 8 - Green 9 - Red	0 - None 1 - Black 2 - White 8 - Red	0 - None 1 - I/O Vert. 2 - ON/OFF/ON Vert. 3 - ON/OFF Vert. 4 - ON/OFF Horiz. 9 - I/O/II Vert. S - I/O/II Vert. R - I/O Horiz.	1 - Full / Signal	0 - Clear 1 - Red 2 - Amber 3 - Green 4 - Blue 5 - Yellow	3 - 6V 4 - 12V 6 - 125V 7 - 250V

Notes:
Not All Combinations are Available, Please Check with Sales.
* = Options Available with Illuminated Switches

Custom Colors and Markings Available Upon Request For Illuminated Switches Only

EXAMPLE PART NUMBERS:

- RA11131100 1P Off-On
Black Body/Actuator, No Marking
- RA11131121 1P Off-On
Black Body/Actuator, I/O Vert.
- RA111C1100 1P Off-On
Black Body/Actuator, No Marking
- RA111C1121 1P Off-On
Black Body/Actuator, I/O Vert.
- RA111C1021-116 1P Off-On
Red Illum. Actuator, Black Body, I/O Vert.
- RA11331100 1P On-On
Black Body/Actuator, No Marking
- RA11531100 1P On-Off-On
Black Body/Actuator, No Marking
- RA11531122 1P On-Off-On
Black Body/Actuator, ON/OFF/ON Vert.
- RA13131100 1P Off-On
Black Body/Actuator, PCB Pins, No Marking
- RA1H331100 1P On-On
Black Body/Actuator, Right Angle PCB Pins



E-SWITCH®

SPECIFICATIONS SUBJECT TO CHANGE WITHOUT NOTICE 11.16.2021

X-ON Electronics

Largest Supplier of Electrical and Electronic Components

Click to view similar products for [Rocker Switches](#) category:

Click to view products by [E-Switch](#) manufacturer:

Other Similar products are found below :

[LTI LA6E-1S-WH-RC-FN12VXCR1](#) [6-1571986-9](#) [8007K26N324V52](#) [8055K32Z7V](#) [8055K52Z7V](#) [8138K20E6M50](#) [84206L](#) [84312LX](#)
[PREDD5-07F-BB0GW](#) [999-16716-002](#) [999-16716-003](#) [999-16716-004](#) [A101J1V3Q004](#) [A101J2ZQ004](#) [A101J4ZQ004](#) [A101J51CB0004](#)
[A103J1ZQ004](#) [A201J1AQ004](#) [A201J3ZB004](#) [A201J50ZQ004](#) [A203J51ZQ0004](#) [A435S1YZQ](#) [H8500XBBBBL-A](#) [H8653VBBG2577W](#)
[HB130CHNWWNAAC](#) [R13112ABB-602W](#) [1251.0303](#) [AE205J60V3B004](#) [1352.0107](#) [1500G51E](#) [1571099-3](#) [1571987-4](#) [1571987-5](#)
[1571989-7](#) [1571988-5](#) [B123J77V7B2](#) [B226J50W4Q22P](#) [B433J37ZQ22M](#) [160212E](#) [1634200-7](#) [1801.1164](#) [1839.1502](#) [PANEL-PLUG-VHP-](#)
[BLACK](#) [PANEL-PLUG-VHP-WT](#) [K1ABBSCADN](#) [K2ABAAAAAA](#) [KG312A2DXD246X](#) [250011E714](#) [2600HM11E](#) [2600R21E](#)