

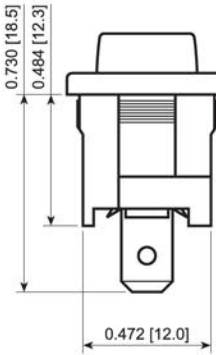

ROCKER

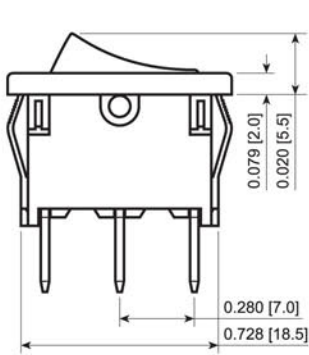

### Actuator Options

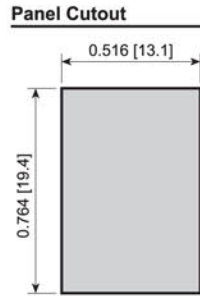
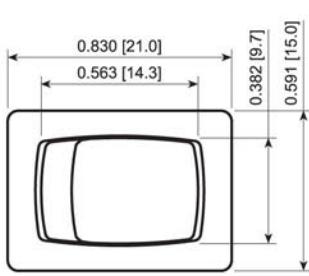
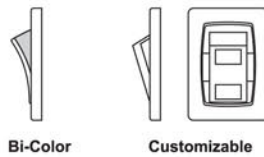

### Terminal Options

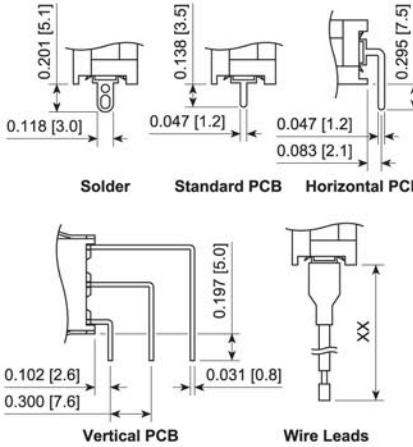

### FEATURES:

- High Rating
- Snap in with Multiple terminal options
- Many Functions Available
- PVC Cap for Dust and Water Protection

### SPECIFICATIONS:

**RATING:** *RATING OPTION C:*  
16A 125VAC [cURus]  
10(6)A 250V- 1E4 T85 [ENEC]  
6(4)A 250V- 5E4 T85 [ENEC]

*Rating Option 3:*  
11A 125VAC [cURus]  
5.5A 250VAC [cURus]  
4A 250V- 1E4 T55 [ENEC]

*Ratings of Illuminated Switches May Vary*

TEMPERATURE: -20°C to 55°C Min.  
ELECTRICAL LIFE: 10,000 Cycles  
CONTACT RESISTANCE: 30mΩ Max.  
INSULATION RESISTANCE: 500MΩ Min. at 500VDC  
DIELECTRIC STRENGTH: 1,000VAC for 1 Minute  
INGRESS PROTECTION: IP54 with PVC Cap

### MATERIALS:

**BODY:** Polyamide 6/6, UL94 V-2  
**ACTUATOR:** Polyamide 6/6, UL94 V-2  
Polycarbonate, UL94 V-2  
**CONTACTS:** Silver Alloy  
**TERMINALS:** Silver Plated Copper

### Water Protection Option

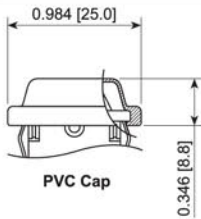

### Illumination Options

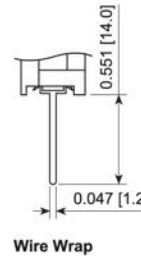
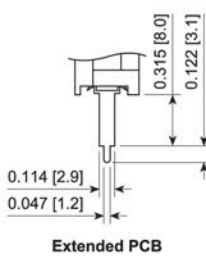
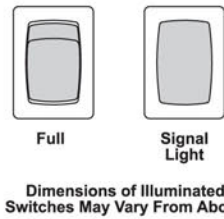

RA111C1A00



RA111C1021-116



RA111C1213

RA113C1100  
ACC-P01

Series	Terminal	Function	Rating	Body Color	Actuator Color	Marking Color	Marking Type	Lens Style	Lens Color	Lamp Voltage
RA1 - Curved Actuator	0 - Blank	0 - Signal / Blank	0 - Signal / Blank	1 - Black	0 - Illuminated	0 - None	0 - None	1 - Full / Signal	0 - Clear	3 - 6V
RA1C - Customizable Actuator	1 - 4.8mm Tab (*)	1 - Off-On (*)	3 - 11A 125V	2 - White	1 - Black	1 - Black	1 - I/O Vert.	0 - Clear	1 - Red	4 - 12V
	2 - Solder (*)	3 - On-On	C - 16A 125V	3 - Almond	2 - White	2 - White	2 - ON/OFF/ON Vert.	2 - Amber	3 - Green	6 - 125V
	3 - PCB Pin	4 - Off-(On)		4 - Grey	3 - Almond	8 - Red	3 - ON/OFF Vert.	4 - Blue	4 - Blue	7 - 250V
	H - Horiz. PCB	5 - On-Off-On		5 - Orange	4 - Grey		4 - ON/OFF Horiz.	5 - Yellow		
	V - Vert. PCB	A - On-(Off)		7 - Blue	5 - Orange		5 - I/O/II Horiz.			
	A14 - Wire Wrap	C - On-Off-(On)		8 - Green	7 - Blue		6 - I/O/III Vert.			
	E08 - Ext. PCB	D - (On)-Off-(On)		9 - Red	8 - Green		7 - I/O/IV Horiz.			
	Wxx - Wire Leads (xx in Inches)				9 - Red		8 - I/O/V Horiz.			

Notes:  
Not All Combinations are Available, Please Check with Sales.  
\* = Options Available with Illuminated Switches

Custom Colors and Markings Available Upon Request

For Illuminated Switches Only

### EXAMPLE PART NUMBERS:

- RA11131100 1P Off-On Black Body/Actuator, No Marking
- RA11131121 1P Off-On Black Body/Actuator, I/O Vert.
- RA111C1100 1P Off-On Black Body/Actuator, No Marking
- RA111C1121 1P Off-On Black Body/Actuator, I/O Vert.
- RA111C1021-116 1P Off-On Red Illum. Actuator, Black Body, I/O Vert.
- RA11331100 1P On-On Black Body/Actuator, No Marking
- RA11531100 1P On-Off-On Black Body/Actuator, No Marking
- RA11531122 1P On-Off-On Black Body/Actuator, ON/OFF/ON Vert.
- RA13131100 1P Off-On Black Body/Actuator, PCB Pins, No Marking
- RA1H331100 1P On-On Black Body/Actuator, Right Angle PCB Pins



E-SWITCH®

www.e-switch.com

800.867.2717

SPECIFICATIONS SUBJECT TO CHANGE WITHOUT NOTICE

## X-ON Electronics

Largest Supplier of Electrical and Electronic Components

*Click to view similar products for [Rocker Switches](#) category:*

*Click to view products by [E-Switch](#) manufacturer:*

Other Similar products are found below :

[LTI LA6E-1S-WH-RC-FN12VXCR1](#) [6-1571986-9](#) [8007K26N324V52](#) [8055K32Z7V](#) [8055K52Z7V](#) [8138K20E6M50](#) [84206L](#) [84312LX](#)  
[PREDD5-07F-BB0GW](#) [999-16716-002](#) [999-16716-003](#) [999-16716-004](#) [A101J1V3Q004](#) [A101J2ZQ004](#) [A101J4ZQ004](#) [A101J51CB0004](#)  
[A103J1ZQ004](#) [A201J1AQ004](#) [A201J3ZB004](#) [A201J50ZQ004](#) [A203J51ZQ0004](#) [A435S1YZQ](#) [H8500XBBBBL-A](#) [H8653VBBG2577W](#)  
[HB130CHNWWNAAC](#) [R13112ABB-602W](#) [1251.0303](#) [AE205J60V3B004](#) [1352.0107](#) [1500G51E](#) [1571099-3](#) [1571987-4](#) [1571987-5](#)  
[1571989-7](#) [1571988-5](#) [B123J77V7B2](#) [B226J50W4Q22P](#) [B433J37ZQ22M](#) [160212E](#) [1634200-7](#) [1801.1164](#) [1839.1502](#) [PANEL-PLUG-VHP-](#)  
[BLACK](#) [PANEL-PLUG-VHP-WT](#) [K1ABBSCADN](#) [K2ABAAAAAA](#) [KG312A2DXD246X](#) [250011E714](#) [2600HM11E](#) [2600R21E](#)