

RDM SERIES ROTARY DIP SWITCH

ANTI-VANDAL SWITCHES
DETECTOR SWITCHES
DIP SWITCHES
KEYLOCK SWITCHES
NAVIGATION SWITCHES
PUSHBUTTON SWITCHES
ROCKER SWITCHES
ROTARY SWITCHES
SLIDE SWITCHES
SNAP ACTION SWITCHES
TACTILE SWITCHES
TOGGLE SWITCHES
CAP OPTIONS

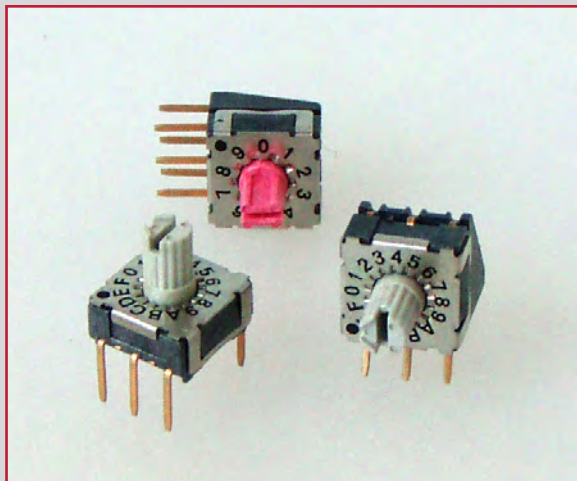

APPLICATIONS / MARKETS



Audio / Visual

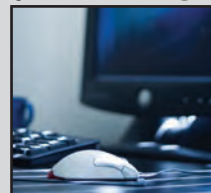

Computer Peripherals



Consumer Electronics

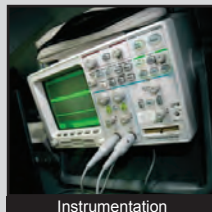

Instrumentation

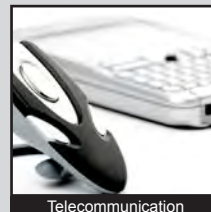

Telecommunication



Medical Equipment

RoHS

SPECIFICATIONS

Electrical Rating:
Switching: 42VDC, 100mA
Non-Switching: 42VDC, 400mA
Life Expectancy: 25,000 steps
Contact Resistance: 80mΩ Max.
Insulation Resistance: 100 MΩ Min. at 250VDC
Dielectric Strength: 250VAC 1 min.
Operating Temperature: -60°C to 125°C
Actuation Force: 120 gf +/- 30gf
Travel: dependent upon individual switch positions

FEATURES & BENEFITS

- Offers IP67 sealing protection
- Available in 10 or 16 positions
- Ultra slim size for high density mounting
- Gold contacts

PART NUMBER CONFIGURATOR

Series	Actuator	Code	Positions	Terminals	Packaging
<input type="text" value="RDM"/>	<input type="text" value="A"/>	<input type="text" value="R"/>	<input type="text" value="10"/>	<input type="text" value="P1"/>	<input type="text" value="T"/>
	A - Arrow Flush B - Shaft 4.5 high E - Shaft 4.2 high	R - Real C - Complementary	10 16	P1 - TH 3x3 terminals S1 - SM 3x3 terminals R1 - Angled 5.08 spacing R2 - Angled 2.54 spacing	T - Tube R - Tape & Reel

Specifications subject to change without notice



E-SWITCH®

www.e-switch.com

800.867.2717

2

RDM SERIES ROTARY DIP SWITCH

BODY DIMENSIONS

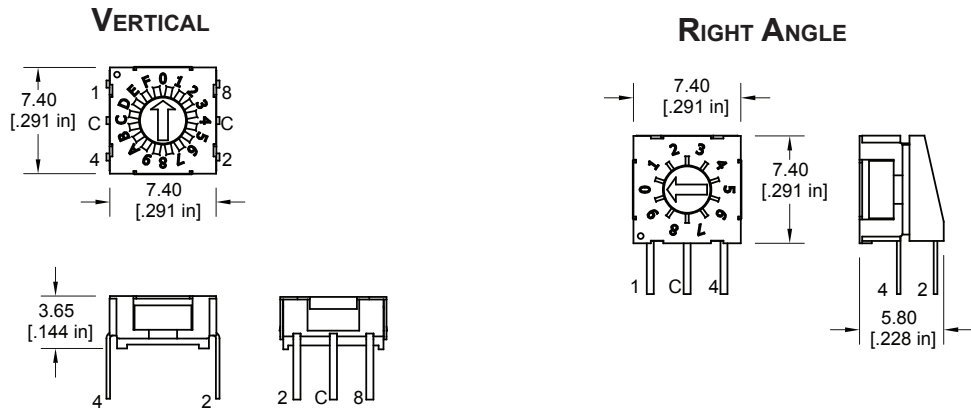

ACTUATOR OPTIONS

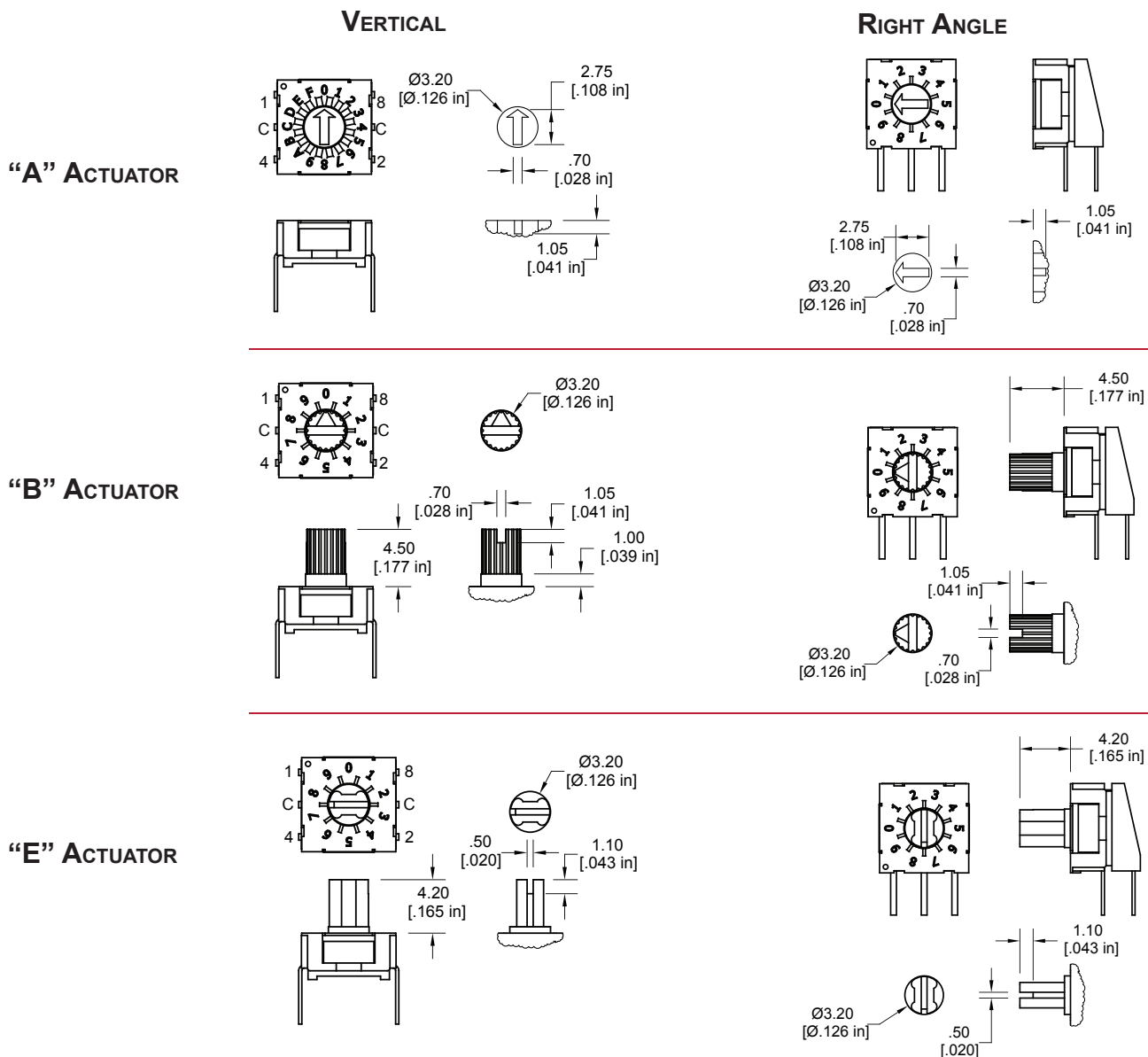

ANTI-VANDAL SWITCHES
 DETECTOR SWITCHES
 DIP SWITCHES
 KEYLOCK SWITCHES
 NAVIGATION SWITCHES
 PUSHBUTTON SWITCHES
 ROCKER SWITCHES
 ROTARY SWITCHES
 SLIDE SWITCHES
 SNAP ACTION SWITCHES
 TACTILE SWITCHES
 TOGGLE SWITCHES
 CAP OPTIONS

RDM SERIES ROTARY DIP SWITCH

GENERAL CODE

COMPLEMENT CODE

	C	1	2	4	8	
0	●	●	●	●	●	0
1	●		●	●	●	1
2	●	●		●	●	2
3	●			●	●	3
4	●	●			●	4
5	●		●			5
6	●	●			●	6
7	●				●	7
8	●	●	●	●		8
9	●		●	●		9
10	●	●		●		A
11	●			●		B
12	●	●	●			C
13	●		●			D
14	●	●				E
15	●					F

16 POSITION (ACTUATOR COLOR: IVORY) 16 POSITION (ACTUATOR COLOR: GRAY)

REAL CODE

	C	1	2	4	8	
0	●					0
1	●	●				1
2	●		●			2
3	●	●	●			3
4	●			●		4
5	●	●		●		5
6	●		●	●		6
7	●	●	●	●		7
8	●				●	8
9	●	●			●	9
10	●		●		●	A
11	●	●	●		●	B
12	●			●	●	C
13	●	●		●	●	D
14	●		●	●	●	E
15	●	●	●	●	●	F

COMPLEMENT CODE

	C	1	2	4	8
0	●	●	●	●	●
1	●		●	●	●
2	●	●		●	●
3	●			●	●
4	●	●	●		●
5	●		●		●
6	●	●			●
7	●				●
8	●	●	●	●	
9	●		●	●	

10 POSITION (ACTUATOR COLOR: ORANGE)

REAL CODE

	C	1	2	4	8
0	●				
1	●	●			
2	●		●		
3	●	●	●		
4	●			●	
5	●	●		●	
6	●		●	●	
7	●	●	●	●	
8	●				●
9	●	●			●

10 POSITION (ACTUATOR COLOR: RED)

TERMINATION OPTIONS

P1 - VERTICAL

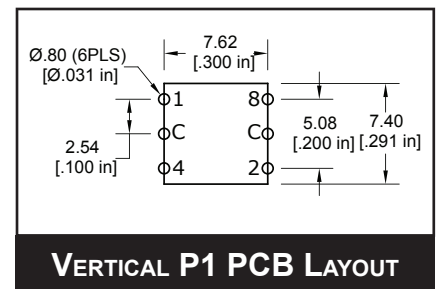
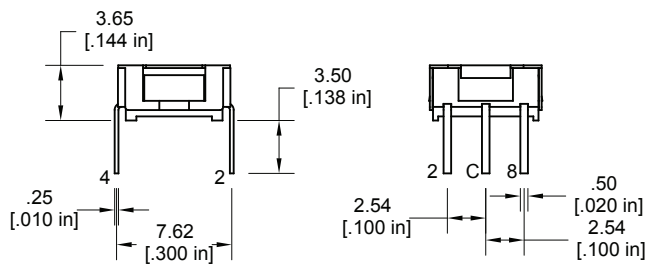

VERTICAL P1 PCB LAYOUT

S1 - VERTICAL

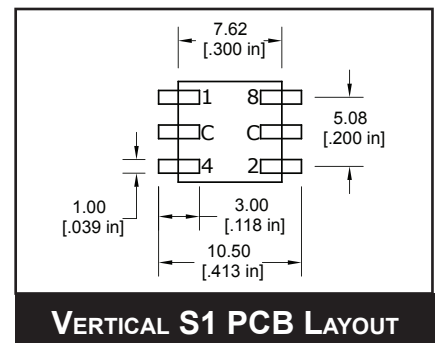
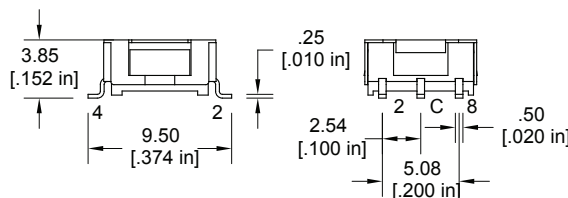

VERTICAL S1 PCB LAYOUT



RDM SERIES ROTARY DIP SWITCH

TERMINATION OPTIONS (CONT.)

R1 - RIGHT ANGLE

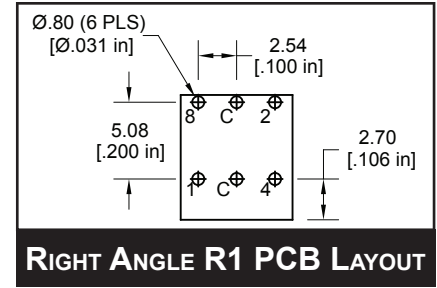
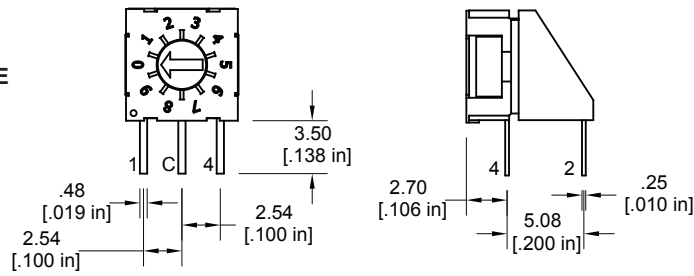

R2 - RIGHT ANGLE

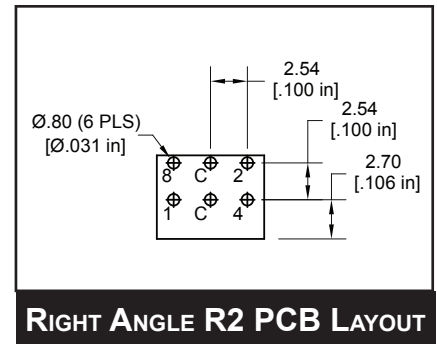
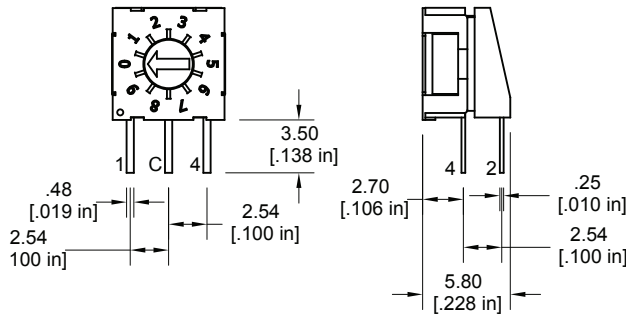

- ANTI-VANDAL SWITCHES
- DETECTOR SWITCHES
- DIP SWITCHES**
- KEYLOCK SWITCHES
- NAVIGATION SWITCHES
- PUSHBUTTON SWITCHES
- ROCKER SWITCHES
- ROTARY SWITCHES
- SLIDE SWITCHES
- SNAP ACTION SWITCHES
- TACTILE SWITCHES
- TOGGLE SWITCHES
- CAP OPTIONS



X-ON Electronics

Largest Supplier of Electrical and Electronic Components

Click to view similar products for [Rotary Switches](#) category:

Click to view products by [E-Switch](#) manufacturer:

Other Similar products are found below :

[57HS22-02-2-06N](#) [57M22-02B16N](#) [57M22-09A16N](#) [M3786/4-0881](#) [M3786/4-3267](#) [M3786/4-5568](#) [M3786/4-6029](#) [71ESF30-05204N](#)
[MC06L1NCGF](#) [84986-26](#) [9003K2C003GA](#) [PLR3251](#) [PLR3262](#) [PS3](#) [A0142M2SP](#) [A029303](#) [R2AA4455NNNN](#) [R2BB4455NNNN](#) [DR75-](#)
[AMSF-10R-B](#) [1703.3201](#) [HW1MS-0202-101](#) [24002-03S](#) [A029101](#) [ACSNO-129-YB-C1014](#) [ACSNO-134-RR-YB-C1005](#) [ACSNO-353-SB-](#)
[C3016](#) [1825537-4](#) [T505](#) [T505E](#) [24005-03N](#) [H10207RR01Q](#) [M3786/39-4ZC](#) [M3786/4-0002](#) [M3786/4-0630](#) [M3786/4-1028L](#) [M3786/4-](#)
[1233L](#) [M3786/4-3044](#) [M3786/4-3129](#) [M3786/4-5008L](#) [M3786/4-5256](#) [MC6CX1A502X009](#) [42HS36-01-1-06N](#) [42P36-03B10S](#) [44MBS60-](#)
[04-2-03N](#) [44MG90-02-1-02N](#) [50KMT90-01-2-02N](#) [51A22-01-1-16S](#) [51CDP30-01PAJN](#) [51KSP30-01D04N](#) [51P30-01B12N](#)