

SV8 SERIES ANTI-VANDAL SWITCH

ANTI-VANDAL SWITCHES
DETECTOR SWITCHES
DIP SWITCHES
KEYLOCK SWITCHES
NAVIGATION SWITCHES
PUSHBUTTON SWITCHES
ROCKER SWITCHES
ROTARY SWITCHES
SLIDE SWITCHES
SNAP ACTION SWITCHES
TACTILE SWITCHES
TOGGLE SWITCHES
CAP OPTIONS

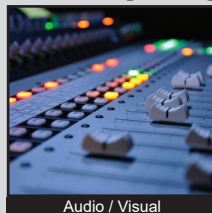

APPLICATIONS / MARKETS



SPECIFICATIONS

Electrical Rating: 2A, 36VDC
Electrical Life: 200,000 Cycles
Contact Resistance: 50mΩ Max. at 1A 12VDC
Dielectric Strength: 2,000V RMS at sea level
Operating/Storage Temperature: -20°C to 70°C
Travel: 1.80mm
Moisture Protection: IP67
Contact Arrangement: SPST
Actuation Force: 4.5 N
Panel Thickness: 1-6mm
Mounting Nut Torque: 1-3Nm

FEATURES & BENEFITS

- Short body design
- 25mm diameter panel cutout
- Multiple LED options
- Ring or Ring/Power symbol illumination available
- IP67 rated
- SPST
- Soldered wire leads (500mm long) optional

PART NUMBER CONFIGURATOR

Series	Actuator Options	Terminal Options	Function Options	Body Finish Options	Actuator Finish Options	Lens Style Options	LED-Color Options	Illumination Voltage Options
<input type="text" value="SV8"/>	<input type="text" value="F - Flat"/>	<input type="text" value="2 - Solder
W - Wire Leads
500mm long"/>	<input type="text" value="3 - 1 Pole
Off - (On)*"/>	<input type="text" value="S - Stainless Steel"/>	<input type="text" value="S - Stainless Steel"/>	<input type="text" value="3 - Ring moveable with Actuator
6 - Ring /Power moveable with Actuator"/>	<input type="text" value="0 - White
1 - Red
3 - Green
4 - Blue
5 - Yellow
G - Red/Green
H - Red/Blue"/>	<input type="text" value="1 - Base Voltage"/>

NOTES:
 *() denotes function is momentary

Specifications subject to change without notice 3.5.2020



E-SWITCH®

www.e-switch.com

800.867.2717

1

SV8 SERIES ANTI-VANDAL SWITCH

BODY DIMENSIONS

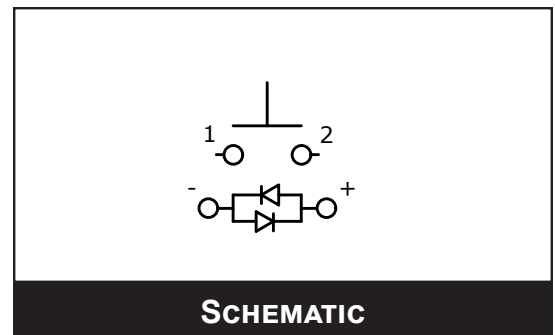
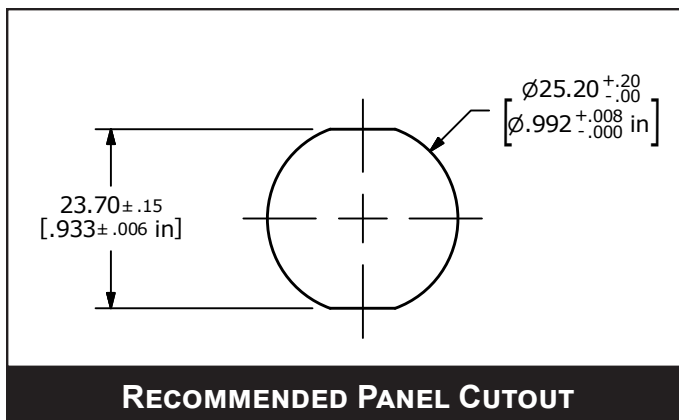
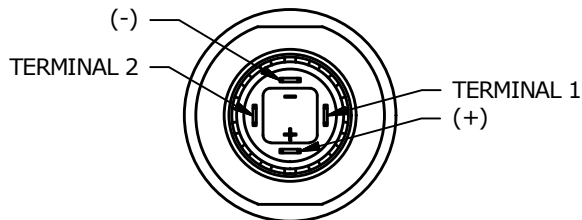
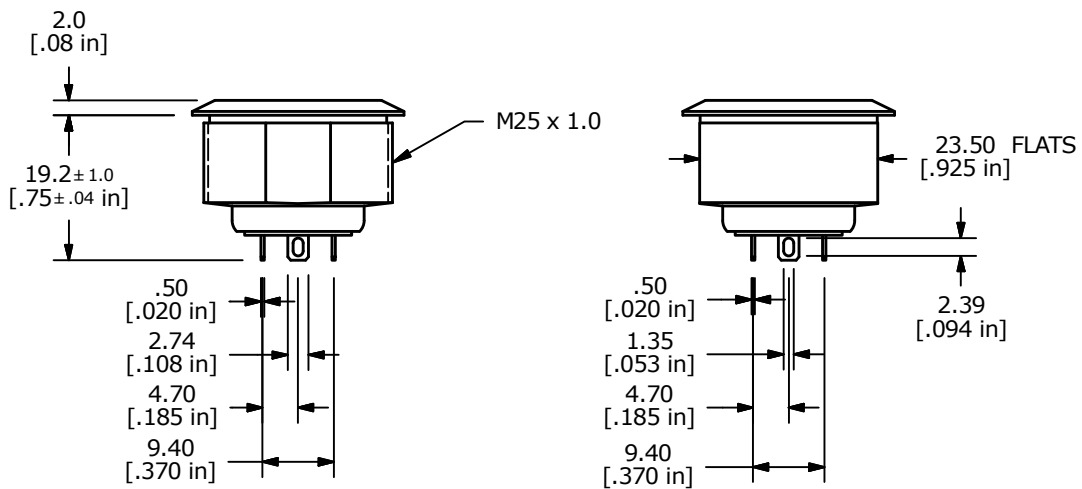
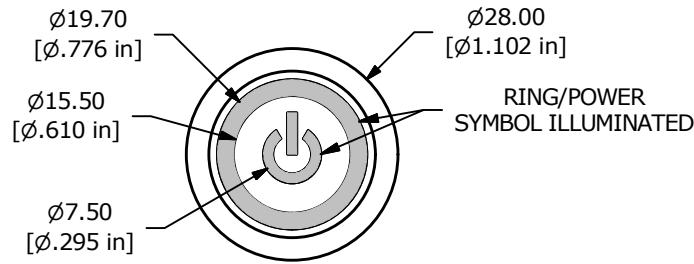

SV8 SERIES ANTI-VANDAL SWITCH

ACTUATOR OPTIONS

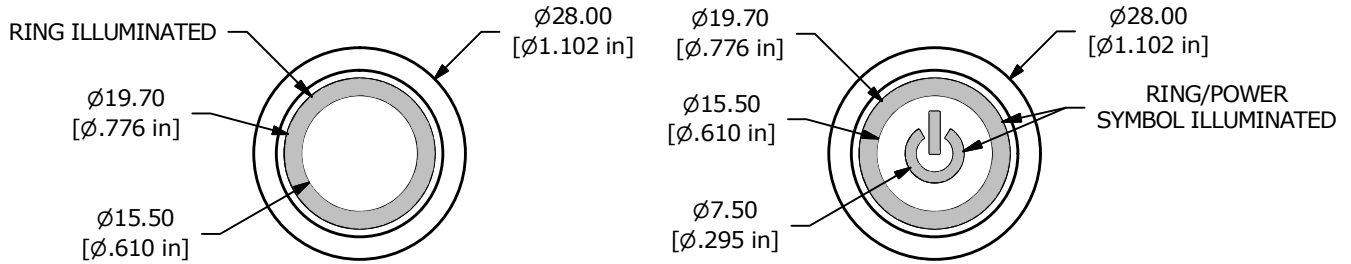

WIRE LEAD OPTION

SWITCH	WIRE	LENGTH
SW1-1	WIRE, 20AWG AWM UL3385, BLACK	500.0 [19.7 in]
SW1-2	WIRE, 20AWG AWM UL3385, BLACK	500.0 [19.7 in]
SW1- (-)	WIRE, 20AWG AWM UL3385, GREEN	500.0 [19.7 in]
SW1- (+)	WIRE, 20AWG AWM UL3385, RED	500.0 [19.7 in]

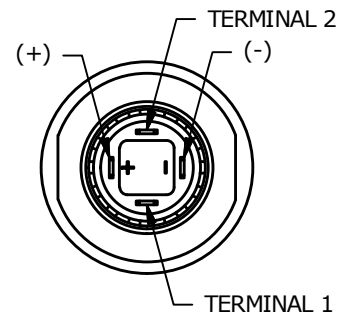
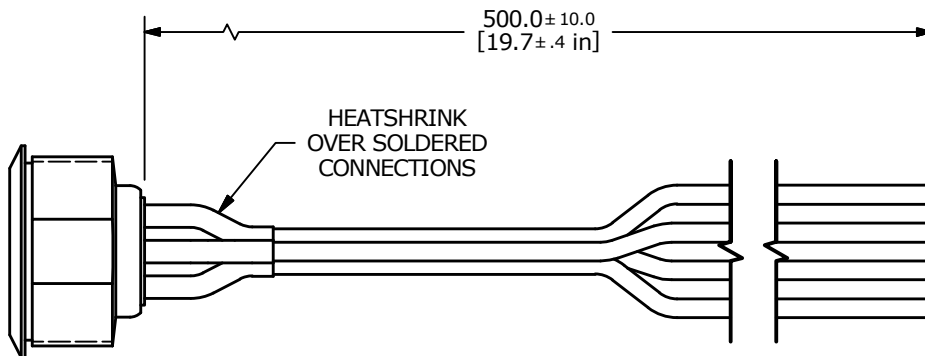

BOTTOM VIEW
SHOWN WITHOUT
WIRING



X-ON Electronics

Largest Supplier of Electrical and Electronic Components

Click to view similar products for [Pushbutton Switches](#) category:

Click to view products by [E-Switch](#) manufacturer:

Other Similar products are found below :

[8940K2012](#) [LW1L-M1C10V-A](#) [LW1L-M1C70-A](#) [LW2L-A1C20M-GD](#) [LW2L-M1C20M-A](#) [60324L](#) [M22-D-R-GB0/K11](#) [M7E-HRN2](#)
[67021K512](#) [67081K512X](#) [701PB580](#) [7190K101](#) [7199K101](#) [810K12910](#) [810KSV30B](#) [MML21EA2ADK](#) [MML21KA3ABK](#)
[MML23KA3AC05K-001](#) [MML23KW3AA01W](#) [8418K2](#) [8442K3](#) [8450K1](#) [860K11911T01A](#) [861901](#) [861K11911T01A07](#)
[861K13810T00A14](#) [861K13911](#) [8646AB6X718UL](#) [8646ABUL](#) [9001KXRK](#) [907AYY100](#) [PMHD155A1](#) [95-313.000](#)
[9533CD4+U574+U4922](#) [95-414.000](#) [99-450.837](#) [99-453.837](#) [PV3H2B0NN-341](#) [1203MRA](#) [A22NZBGANGA](#) [A22NZBMMNGA](#)
[A22NZBNANGA](#) [A22NZMPATRA](#) [A2PMA1X03EC56](#) [A3A-5123-02](#) [A3A-7140](#) [A3A-7310](#) [A3A-7340](#) [A3U-TMW-A2C-5M](#) [A595](#)