

PUSHBUTTON SWITCHES

SERIES TA/LT

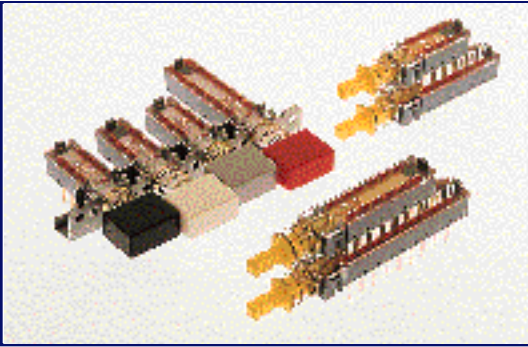

TA/LT Series push button switches offer an “ultra-lite” alternative to design engineers working in a variety of applications. Available features include:

- Spring loaded, wiping contacts for smooth, silent actuation stroke and excellent reliability
- Up to 16 poles per module
- Mounting chassis available.
- Interlocked assemblies up to 20 stations
- Optional terminal length
- Snap-on buttons
- Solder lugs on top for hand wiring; PC at bottom for flow soldering
- Switch plunger with sliding contacts can be removed from the front without disturbing electrical connections.
- Fixed terminals are epoxied and “staked” in position, providing an extra seal to help prevent wicking of solder or flux.

SPECIFICATIONS

RATING: 0.5 A@ 100 VAC, 0.2A@ 250 VAC, 1A@ 25 VDC
CONTACT RESISTANCE: 20 m typical
INSULATION RESISTANCE: Adjacent Contacts — 2×10^{12} min. (Dry Condition)
DIELECTRIC STRENGTH: 1,500 V RMS min.
LIFE CYCLE: 100,000 cycles min.
OPERATING TEMPERATURE RANGE: -20° to +70°C
FUNCTIONS AVAILABLE:
 GR = Interlocking
 OA = Momentary
 EE = Latching
 TA = Standard Operating Force (See Next Page)
 LT = Light Touch Operating Force (See Next Page)
 S = Shorting (MBB)
 N = Non-Shorting (BBM)



MATERIALS

HOUSING: Polycarbonate (UL94-HB) Std.
 Valox (UL94-VO)
PLUNGER: Duracon (UL94-HB) Std.
 Valox (UL94-VO)
TERMINALBOARD: Polycarbonate (UL94-HB) Std.
MOVING CONTACTS: Silver plated copper alloy
 Gold plate over nickel plated copper alloy
FIXED CONTACTS: Copper alloy with silver plate over nickel plate
TERMINAL SEAL: High strength bonding red resin
RELEASE BAR: Steel / zinc plated
CHASSIS: Steel / Nickel plated or steel/zinc plated

HOW TO ORDER INDIVIDUAL MODULES

Series (Operating Force)	Pole	Mechanical Configuration	Termination	Contact Material	Housing/Plunger Material	Timing	Cap	Cap Color
TA	2U	EE= Latching	A	AG= Silver	P= UL94HB	N= BBM	TAA ¹	Blk
LT	4U	OA= Momentary	B	AU= Gold	V= UL94VO	S= MBB	TAB ²	Wht
	6U		C				TAC ¹	Gry
	8U		E				TAD ¹	Red
	10U		F				TAE ¹	Blu
	16U						TAG ²	Chr
							TAK ³	
							TAL ³	Blk
							TAM ⁴	Gry
							TA12	Yel
							TA2800 ⁵	Blu
							.08	Red
							.09	Grn
							.094	Wht

¹Blk, Gry, Wht, Red Only
²Blk, Gry, Wht, Red, Chr Only
³Blk & Gry Only
⁴Blk, Gry, Wht Only
⁵Blk & Red Only

Example:

TA → 10U → OA → E → AU → P → S → TA12 → Blu

SPECIFICATIONS SUBJECT TO CHANGE WITHOUT NOTICE.

TA2UEE A

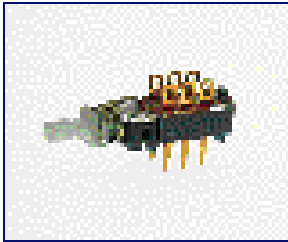

TA4UEE A

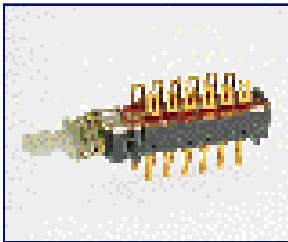

MODULE SCHEMATICS

TOP

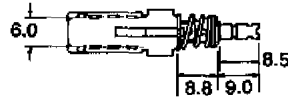

SIDE

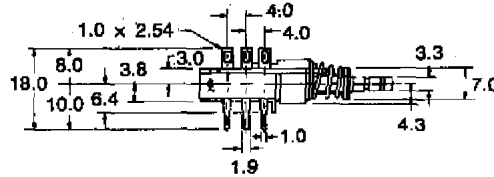

BOTTOM

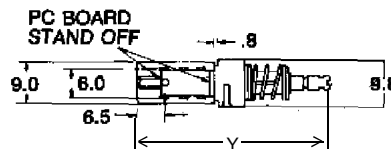

CIRCUIT OPTIONS

2U = DPDT 8U = 8PDT
 4U = 4PDT 10U = 10PDT
 6U = 6PDT 16U = 16PDT

TRAVEL 4.8
 TRAVEL TO LOCK 3.3
 TOLERANCE ±0.2MM

POLE DIMENSIONS

	Y
2PDT	42.15
4PDT	54.15
6PDT	66.15
8PDT	78.15
10PDT	90.15
16PDT	126.15

OPERATING FORCE OPTIONS

(TA) STANDARD OPERATING FORCE

2PDT 700 grams
 4PDT 700 grams
 6PDT 1000 grams
 8PDT 1000 grams
 10PDT 1200 grams
 16PDT 1200 grams

(LT) LIGHT TOUCH OPERATING FORCE

2PDT 250 grams
 4PDT 400 grams
 6PDT 650 grams

TERMINATION OPTIONS

RETENTIVE PIN OPTION

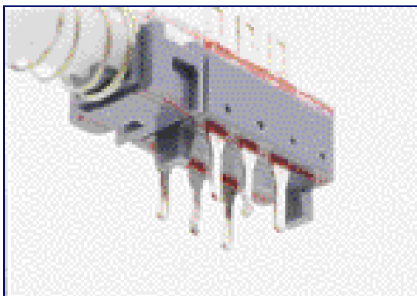

A B C E F

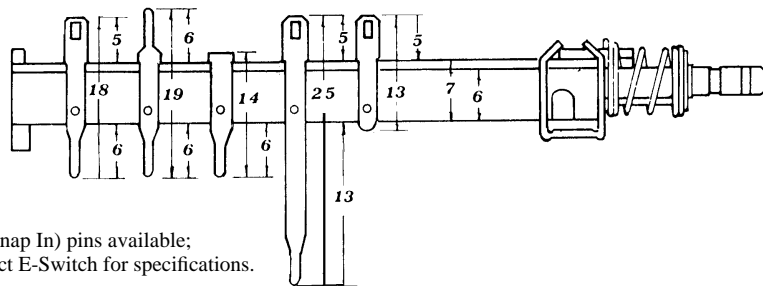

*Retentive (Snap In) pins available;
 please contact E-Switch for specifications.

PLATING, MATERIAL & TIMING OPTIONS

PLATING

AG = Silver
 AU = Gold

MATERIAL

P = Polycarbonate UL94HB
 V = Valox UL94VO

TIMING

N = (BBM) Non-Shorting
 S = (MBB) Shorting

SPECIFICATIONS SUBJECT TO CHANGE WITHOUT NOTICE.

PIGGYBACK PUSHBUTTON SWITCHES

SERIES TA/LT

LIGHT TOUCH PIGGYBACK

A020901

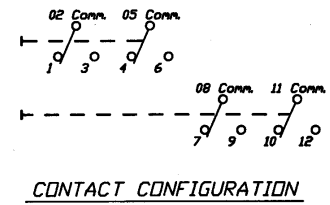
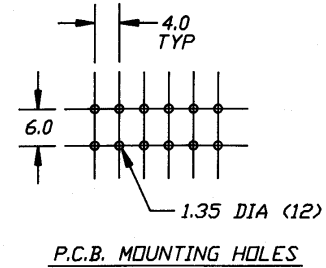
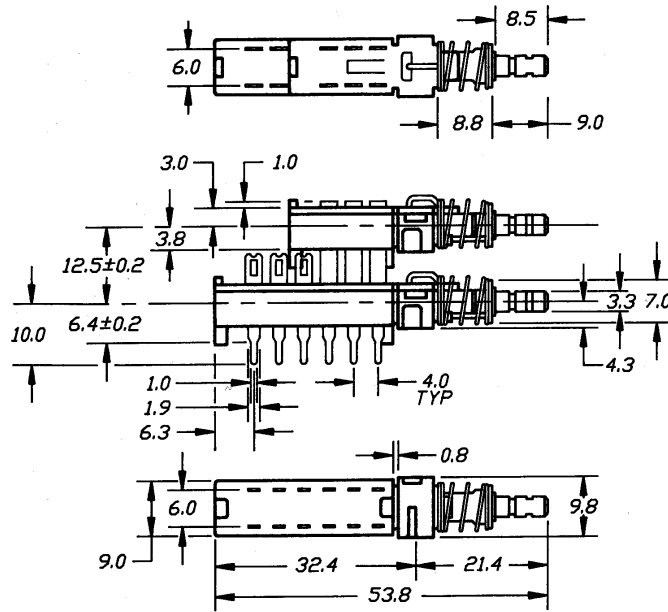
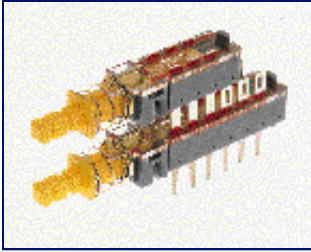

A020903

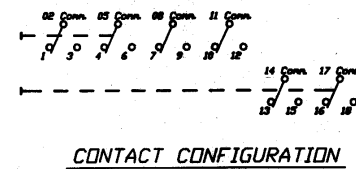
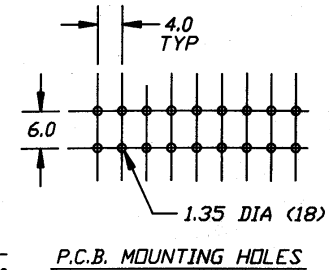
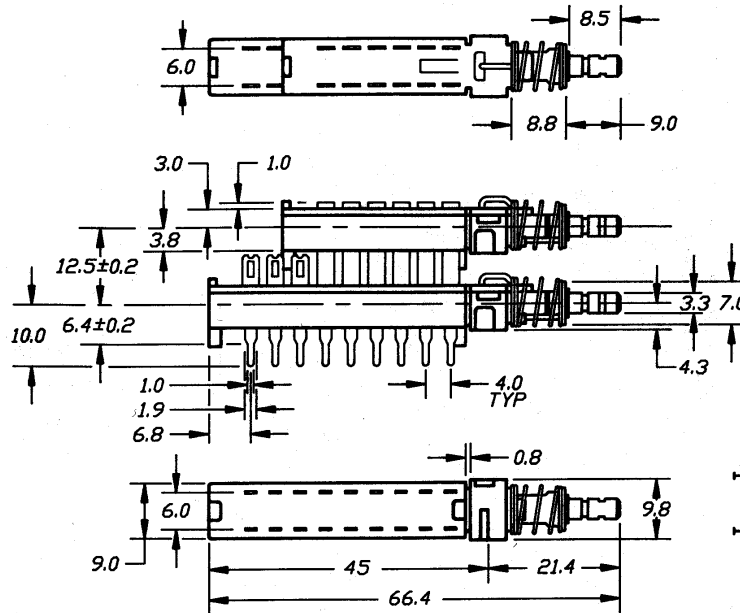
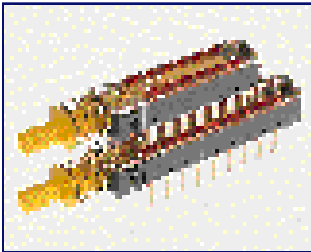

The light touch piggyback is often used where space is a premium or where 2 vertical push buttons are required. The top switch mechanism controls the front terminals. The bottom switch mechanism controls the back terminals.

HOW TO ORDER LIGHT TOUCH PIGGYBACK MODULES

To order, simply give model number:

MODEL NUMBER:

A020901

A020903

SPECIFICATIONS SUBJECT TO CHANGE WITHOUT NOTICE.

CHASSIS & ASSEMBLY

ASSEMBLY CHASSIS

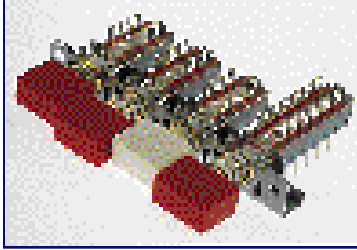

THE ABOVE EXAMPLE SHOWS:

- A 4 station TAs with
- 15mm spacing
- All buttons TAB/RED except station 3 which is TAB/WHT
- First 3 stations are 2 pole switches, interlocked
- Station 4 is 4 pole momentary switch
- All switches have standard terminal type A

WHEN ORDERING AN ASSEMBLY:

(See Next Page For Ordering Procedure)

1. When applicable, state whether buttons are to be mounted horizontally or vertically.
2. Please state if buttons are to be shipped bulk.
3. State requirement for cut mounting tabs on chassis in exception area.
4. Inquire about non-standard mounting holes on chassis ends.

REFERENCE DIAGRAMS

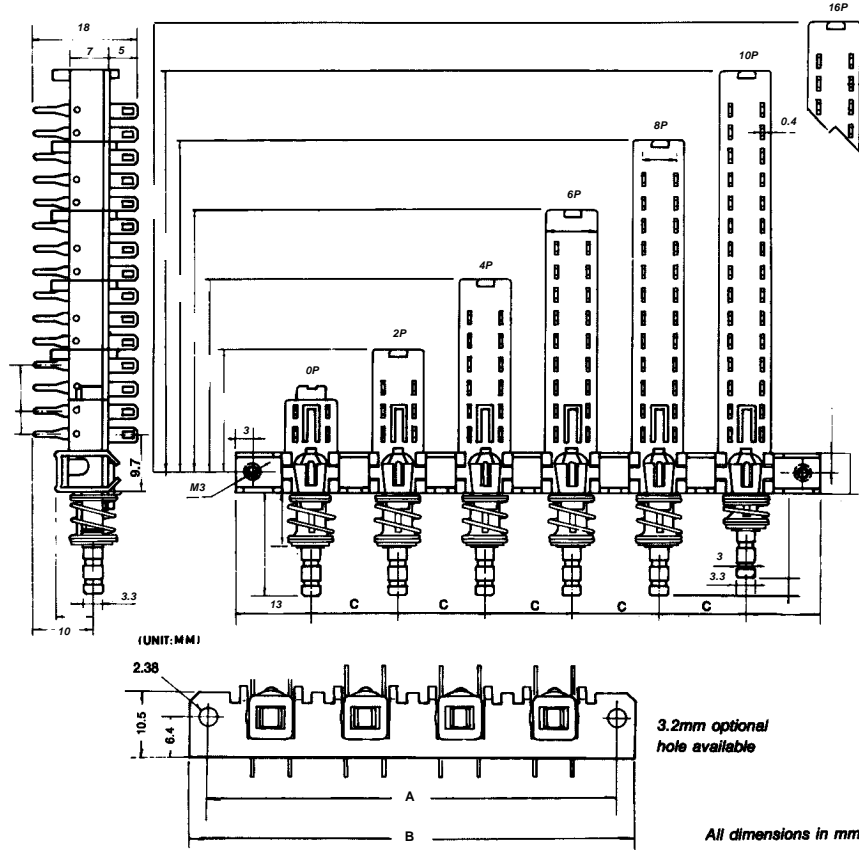

Tolerance $\pm .2m$

STANDARD CHASSIS DIMENSIONS (refer to above schematics)

Number of Stations		2	3	4	5	6	7	8	9	10	11	12	13	14	15	16	17	18	19	20
‘C’Dim. 10mm	‘A’Dim.	30	40	50	60	70	80	90	100	110	120	130	140	150	160	170	180	190	200	210
	‘B’Dim.	36	46	56	66	76	86	96	106	116	126	136	146	156	166	176	186	196	206	216
‘C’Dim. 12.5mm	‘A’Dim.	32.5	45	57.5	70	82.5	95	107.5	120	132.5	145	157.5	170	182.5	195	207.5	220	232.5	245	257.5
	‘B’Dim.	38.5	51	63.5	76	88.5	101	113.5	126	138.5	151	163.5	176	188.5	201	213.5	226	238.5	251	263.5
‘C’Dim. 15mm	‘A’Dim.	35	50	65	80	95	110	125	140	155	170	185	200	215	230	245	260	275	290	305
	‘B’Dim.	41	56	71	86	101	116	131	146	161	176	191	206	221	236	251	266	281	296	311
‘C’Dim. 17.5mm	‘A’Dim.	37.5	55	72.5	90	107.5	125	142.5	160	177.5	195	212.5	230	247.5	265	282.5	300	317.5	335	352.5
	‘B’Dim.	43.5	61	78.5	96	113.5	131	148.5	166	183.5	201	218.5	236	253.5	271	288.5	306	323.5	341	358.5
‘C’Dim. 20mm	‘A’Dim.	40	60	80	100	120	140	160	180	200	220	240	260	280	300	320	340	360	380	400
	‘B’Dim.	46	66	86	106	126	146	166	186	206	226	246	266	286	306	326	346	366	386	406

SPECIFICATIONS SUBJECT TO CHANGE WITHOUT NOTICE.

PUSHBUTTON ASSEMBLIES

SERIES TA/LT

HOW TO ORDER SINGLE STATION ASSEMBLIES

Number of Switches Per Chassis (Operating Force)	Series	Chassis Spacing	Cap	Cap Color	Pole	Mechanical Configuration	Termination	Contact Material	Housing & Plunger Material	Timing	Exceptions to Part Number By Station
1*	TA	0003-00	TAA ¹	Blk, Wht	2U	EE=	A	AG=	P=	N=	(None)
*Single Key Chassis	LT	0003-02	TAB ²	Gry, Red	4U	Latching	B	Silver	Standard	BBM	
		0003-03	TAC ¹	Blu, Chr	6U	OA=	C	AU=	V=	S=	
			TAD ¹		8U	Momentary	E	Gold	Valox	MBB	
			TAE ¹		10U		F				
			TAG ²		16U						
			TAK ³								
			TAL ³								
			TAM ⁴								
			TA12								
			TA2800 ⁵	Blk, Gry							
				Yel, Blu							
				Red, Grn							
				Wht							
			TH100	Wht, Yel							
			TH120	Orn, Grn							
			TH201	Blu							

Desc. (TA0003-00)
ID#AO21251
Standard
2.38 mm holes (.094)

Desc. (TA0003-02)
ID#A021276
Tapped For 4-40 screws

Desc. (TA0003-03)
ID#A021252
3.18 mm holes (.125)

SINGLE KEY CHASSIS

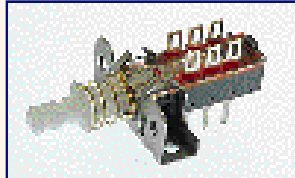
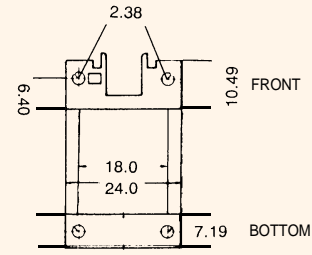



TA0003-00

HOW TO ORDER MULTISTATION ASSEMBLIES

Number of Stations	Series	Chassis Spacing	Cap	Cap Color	Pole	Mechanical Configuration	Termination	Contact Material	Housing & Plunger Material	Timing	Exceptions to Part Number By Station
2	TA	In mm:	TAA ¹	Blk, Wht	2U	EE=	A	AG=	P=	N=	See Below for Procedure
3	LT	10 (.394")	TAB ²	Gry, Red	4U	Latching	B	Silver	Standard	BBM	
4		12.5 (.492")	TAC ¹	Blu, Chr	6U	OA=	C	AU=	V=	S=	
5		15 (.591")	TAD ¹		8U	Momentary	E	Gold	Valox	MBB	
6		17.5 (.689")	TAE ¹		10U	GR=	F				
7		20 (.787")	TAG ²		16U	Interlocked					
8			TAK ³								
9			TAL ³								
10			TAM ⁴								
11			TA12								
12			TA2800 ⁵	Blk, Gry							
13				Yel, Blu							
14				Red, Grn							
15				Wht							
16			TH100	Wht, Yel							
17			TH120	Orn, Grn							
18			TH201	Blu							

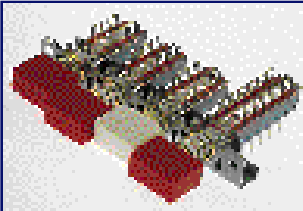
ASSEMBLY CHASSIS



Exceptions to Part Number:
List By Chassis Station #
examples: Station4=4UOA
Station3=TAB/Wht

ORIENTATION: PC pins down, plungers forward—station No. 1 on left.

SPECIFICATIONS SUBJECT TO CHANGE WITHOUT NOTICE.

Example:

12x → TA → 15 → (TAB/Red) → 2U → EE → A → AG → P → N

X-ON Electronics

Largest Supplier of Electrical and Electronic Components

Click to view similar products for [Switch Bezels / Switch Caps](#) category:

Click to view products by [E-Switch](#) manufacturer:

Other Similar products are found below :

[896809000](#) [LW1A-B2-R](#) [LW2A-B1-G](#) [704.604.4](#) [704.955.3](#) [F1403](#) [7527](#) [760203000](#) [760503000](#) [766601000](#) [785105000](#) [785106000](#)
[79211759](#) [MG12KB](#) [MH11](#) [MH13](#) [MHU31](#) [MJ1216](#) [MJ1226](#) [MJ33](#) [MJ612](#) [MJ626](#) [MJ627](#) [9001T8BK](#) [908-1634](#) [92-343.200](#) [92-343.400](#)
[95804.920](#) [95CAP-011](#) [95CAP-112](#) [11-932.7](#) [99-901.9](#) [99-902.9](#) [99-909.4](#) [99-909.5](#) [99-920.8](#) [A0261A](#) [11-931.2](#) [11-932.5](#) [11-936](#) [11-937](#)
[AKTSC22B](#) [AW-RF8](#) [161006](#) [1825068-6](#) [184-1872](#) [187-1872](#) [188-1471](#) [1DFBLK](#) [1D-GRY](#)