

TL1275 SERIES TACT SWITCH

ANTI-VANDAL SWITCHES
 DETECTOR SWITCHES
 DIP SWITCHES
 KEYLOCK SWITCHES
 NAVIGATION SWITCHES
 PUSHBUTTON SWITCHES
 ROCKER SWITCHES
 ROTARY SWITCHES
 SLIDE SWITCHES
 SNAP ACTION SWITCHES
TACTILE SWITCHES
 TOGGLE SWITCHES
 CAP OPTIONS

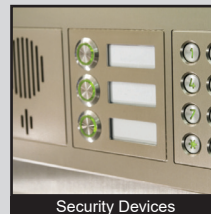

APPLICATIONS / MARKETS

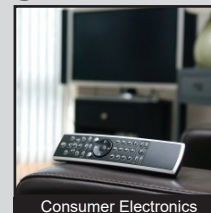
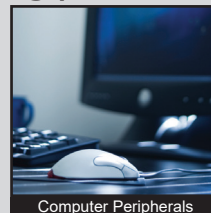

RoHS

SPECIFICATIONS

Contact Arrangement: SPST
Contact Rating: 50mA @ 12VDC
Contact Resistance: 100mΩ Initial
Insulation Resistance: 100 MΩ Min.
Dielectric Strength: 250V RMS
Electrical Life: 100,000 cycles
Operating Temperature: -25°C to 70°C
Storage Temperature: -25°C to 70°C
Travel: 0.25mm ± 0.1mm
Actuation Force: 350 gf ± 100gf
Panel Thickness: 3.5mm Max.

FEATURES & BENEFITS

- 500mm long wire leads with connectors
- Single color and bi-color LED options
- Sharp tactile response
- Panel Mount

PART NUMBER CONFIGURATOR

Series	Actuator	Housing	Termination	Contact Material	Cap	LED Color
TL1275	C - Snap-in Bezel	A2 - Standard Housing	WA500 - 500mm Long Wire Leads	Q - Silver	P - Illuminated Power Symbol	R - Red B - Blue G - Green W - White Y - Yellow RG - Red-Green

Specifications subject to change without notice 12.5.2018



E-SWITCH®

www.e-switch.com

800.867.2717

1

TL1275 SERIES TACT SWITCH

BODY DIMENSIONS

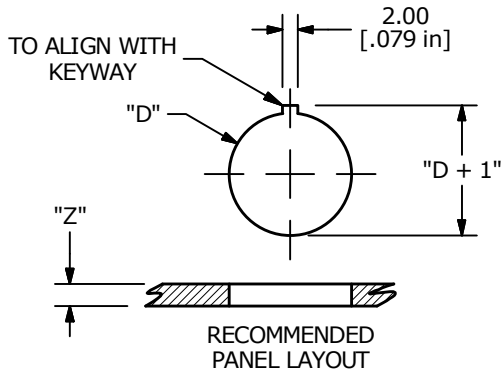

"Z"	"D"
0-0.5	16.0-16.1
0.5-2.0	16.1-16.2
2.0-2.5	16.2-16.4
2.5-3.0	16.4-16.6
3.0-3.5	16.6-16.8

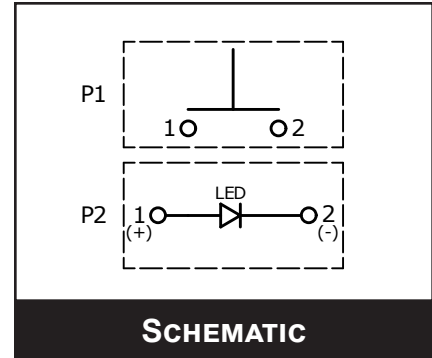

WIRE CHART			
CONNECTOR	POSITION	SWITCH	WIRE
P1	1	1	300V 105°C 26 AWG AWM, BLACK
P1	2	2	300V 105°C 26 AWG AWM, BLACK
P2	1	+	300V 105°C 26 AWG AWM, RED
P2	2	-	300V 105°C 26 AWG AWM, GREEN

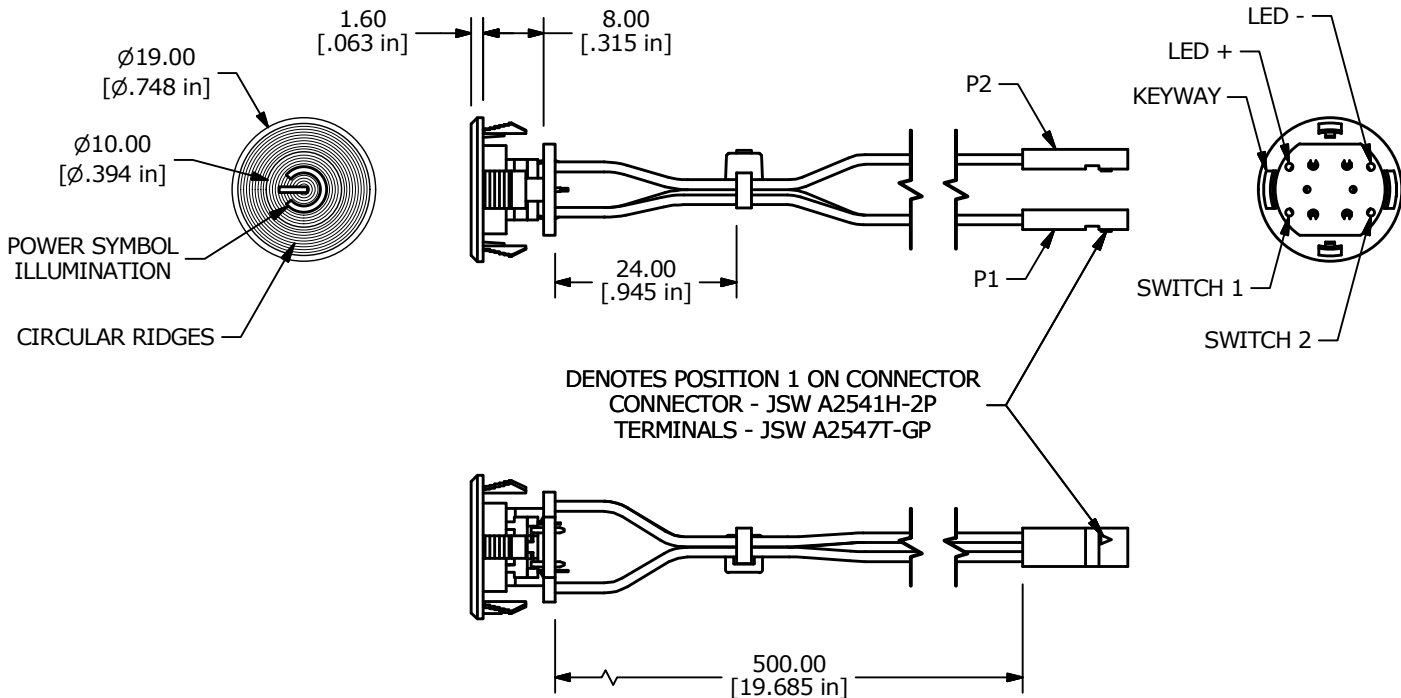
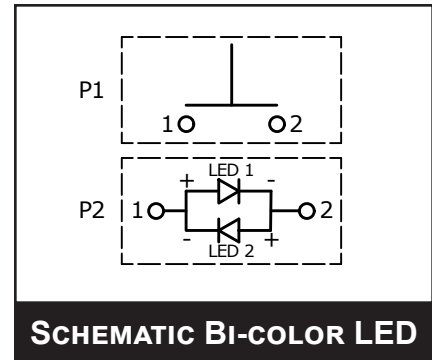

ANTI-VANDAL SWITCHES
DETECTOR SWITCHES
DIP SWITCHES
KEYLOCK SWITCHES
NAVIGATION SWITCHES
PUSHBUTTON SWITCHES
ROCKER SWITCHES
ROTARY SWITCHES
SLIDE SWITCHES
SNAP ACTION SWITCHES
TACTILE SWITCHES
TOGGLE SWITCHES
CAP OPTIONS

X-ON Electronics

Largest Supplier of Electrical and Electronic Components

Click to view similar products for [Tactile Switches](#) category:

Click to view products by [E-Switch](#) manufacturer:

Other Similar products are found below :

[5GTH92001](#) [5GTH9202242](#) [1-1977120-4](#) [ADTSA62RV](#) [ADTSA63KV](#) [ADTSA644NV](#) [ADTSMW66NV](#) [ADTSMW67RV](#) [B3F-3123](#) [B3F-6055A](#) [B3F-B32-01-KIT](#) [1977177-8](#) [1977266-1](#) [ADTS644KV](#) [ADTSA61RV](#) [ADTSA62KV](#) [ADTSA63NV](#) [ADTSA63RV](#) [ADTSM21NSVTR](#) [ADTSM32NVTR](#) [ADTSM63SVTR](#) [ADTSM644KVTR](#) [ADTSMW64RV](#) [ADTSMW69NV](#) [FSMRA4JHA04](#) [GS4.70F300QP](#) [3ESH9R](#) [506E00201](#) [MJTP1164TR](#) [3FTL600RAS](#) [3FTL640RAS](#) [Y96K132V0FPLFS](#) [101-TS5022T1601-EV](#) [5GSH92001](#) [KSJ0A231](#) [80SH LFG](#) [EVQ-P1D05K](#) [MJTP1162TR](#) [ADTSM63KV](#) [2-1977120-7](#) [TSJW-5.2-260-TR](#) [KMT011MNGJLHS](#) [ADTSA648RV](#) [70-201.0](#) [ADTSM62KSVTR](#) [ATA600VTR](#) [ADTSG66RV](#) [ADTS61NV](#) [ADTSM62KVTR](#) [ADTSM25KSVB](#) [ADTS65RV](#)