

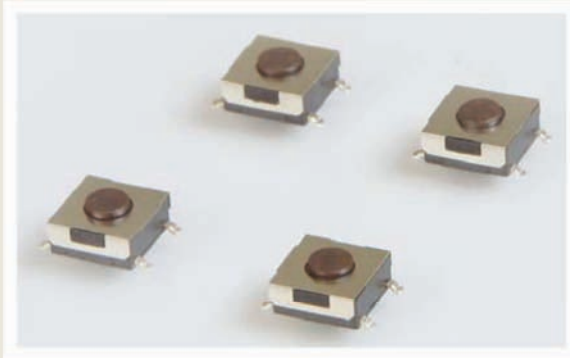

SERIES TL 3303 SWITCHES

TACT SWITCHES SMT - 6mm x 6mm



SPECIFICATIONS

Contact Rating:	50mA @ 12 VDC
Life Expectancy:	100,000 cycles typical
Contact Resistance:	100mΩ max. initial @ 2-4 VDC
Insulation Resistance:	100MΩ min.
Dielectric Strength:	250 VAC
Actuation Force:	100 ± 50 gf, 160 ± 50 gf, 260 ± 50 gf
Operating Temperature:	-20°C to 70°C
Travel:	0.25mm Typ

FEATURES & BENEFITS

- ▶ Earth ground terminal options
- ▶ Reliable dome contact technology
- ▶ Strong tactile/audible feedback

APPLICATIONS/MARKETS

- ▶ Telecommunications
- ▶ Consumer Electronics
- ▶ Audio/visual
- ▶ Medical
- ▶ Testing/instrumentation
- ▶ Computer/servers/peripherals

HOW TO ORDER

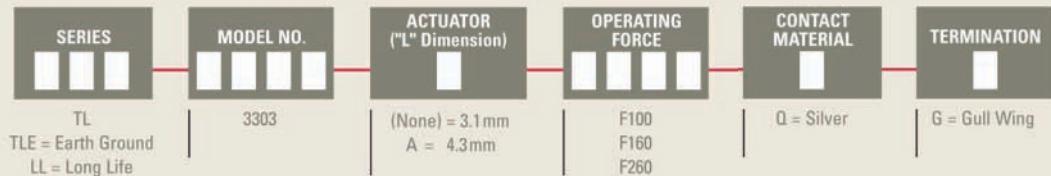

Example Ordering Number

TL-3303-F160-Q-G

Specifications subject to change without notice.

TL 3303/LL 3303

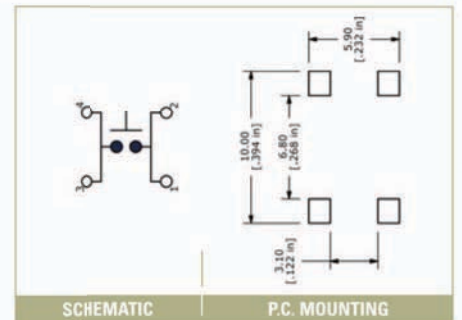
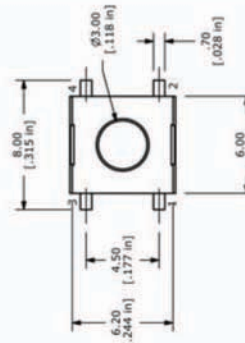
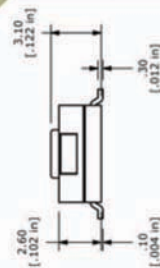

TLE 3303

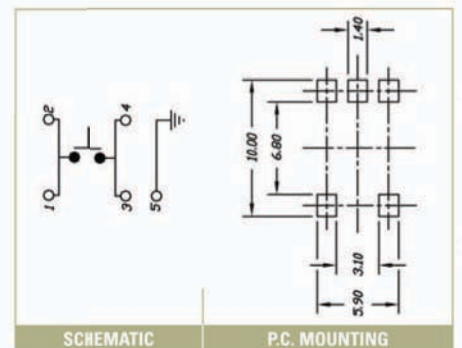
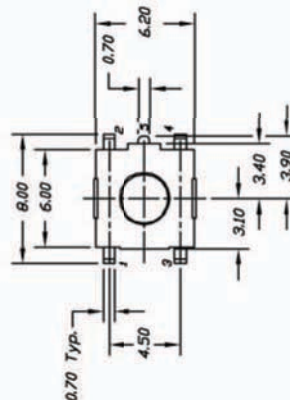
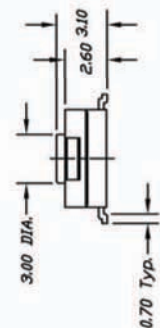

X-ON Electronics

Largest Supplier of Electrical and Electronic Components

Click to view similar products for [Tactile Switches](#) category:

Click to view products by [E-Switch](#) manufacturer:

Other Similar products are found below :

[5GTH92001](#) [5GTH9202242](#) [1-1977120-4](#) [ADTSA62RV](#) [ADTSA63KV](#) [ADTSA644NV](#) [ADTSMW66NV](#) [ADTSMW67RV](#) [B3F-3123](#) [B3F-6055A](#) [B3F-B32-01-KIT](#) [1977177-8](#) [1977266-1](#) [ADTS644KV](#) [ADTSA61RV](#) [ADTSA62KV](#) [ADTSA63NV](#) [ADTSA63RV](#) [ADTSM21NSVTR](#) [ADTSM32NVTR](#) [ADTSM61YVTR](#) [ADTSM63SVTR](#) [ADTSM644KVTR](#) [ADTSMW64RV](#) [ADTSMW69NV](#) [FSMRA4JHA04](#) [GS4.70F300QP](#) [3ESH9R](#) [506E00201](#) [MJTP1164TR](#) [3FTL600RAS](#) [3FTL640RAS](#) [Y96K132V0FPLFS](#) [101-TS5022T1601-EV](#) [5GSH92001](#) [KSJ0A231](#) [80SH LFG](#) [EVQ-P1D05K](#) [MJTP1162TR](#) [ADTSM63KV](#) [2-1977120-7](#) [TSJW-5.2-260-TR](#) [KMT011MNGJLHS](#) [ADTSA648RV](#) [70-201.0](#) [ADTSM62KSVTR](#) [ATA600VTR](#) [ADTSG66RV](#) [ADTS61NV](#) [ADTSM62KVTR](#) [ADTSM25KSVB](#)