

SWITCH SCHEMATIC

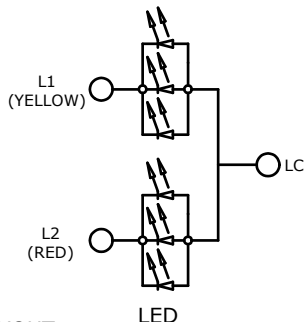

CIRCUIT LAYOUT

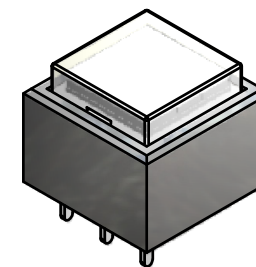
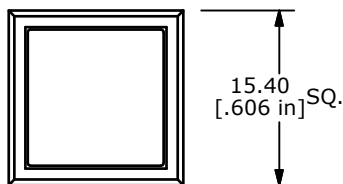

ISOMETRIC

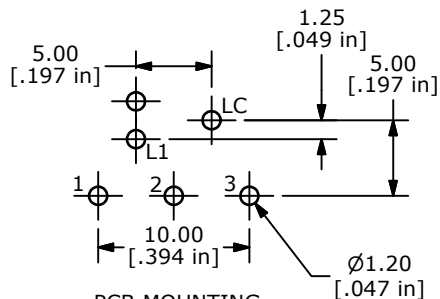

PCB MOUNTING

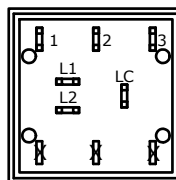
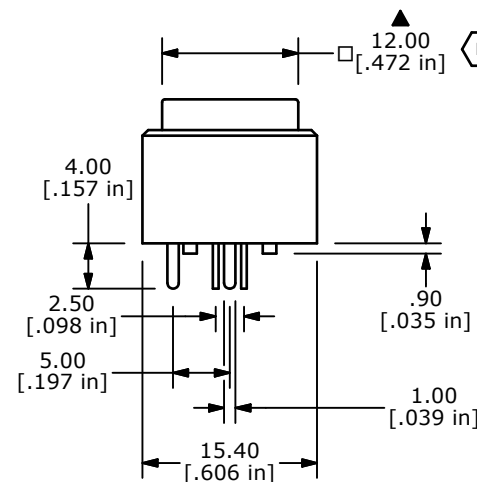
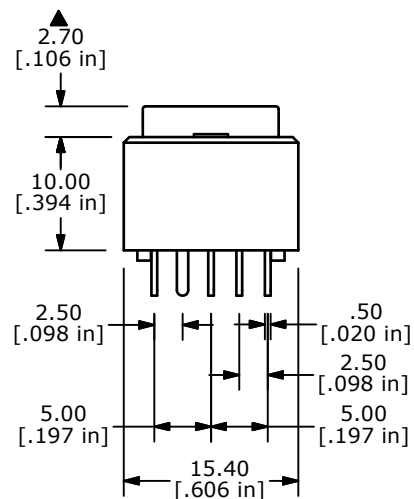

NOTES:

1. ALL DIMENSIONS IN MM
2. GENERAL TOLERANCE: X.X=±0.4
X.XX=±0.25
3. TERM. NOS. FOR REFERENCE ONLY.
- ▲ 4. CONTACT RATING: 0.4VA MAX. @ 28 V (AC OR DC)
5. CONTACT MATERIAL: SILVER
6. ELECTRICAL LIFE: 200,000 Typical
7. MECHANICAL LIFE:
1,000,000 CYCLES TYP.
8. OPERATING TEMP: -20°C TO +70°C
9. OPERATING FORCE: 200 ± 100 gf
10. CONTACT RESISTANCE:
50 MILLI-OHM INITIAL TYP. MAX.
11. DIELECTRIC STRENGTH:
1000 VAC FOR 1 MINUTE
12. TRAVEL TO MAKE: 2.20mm ± 0.2
13. 2002/95/EC (ROHS) COMPLIANT
14. ▲ DENOTES CRITICAL PARAMETER
- ▲ 15. LED COLOR: YEL: 3 CHIPS; 2.1VDC, @20mA TYP.
RED: 3 CHIPS; 1.7VDC, @20mA TYP.

LED SPECS	UNITS	YELLOW	RED
FORWARD CURRENT	mA	20	20
FORWARD VOLTAGE @ 20mA	V	1.95 TYP - 2.2 MAX	1.95 TYP - 2.2 MAX
LUMINOUS INTENSITY @ 20mA	mcd	232 TYP.	77 TYP.



B	20169	CORRECT CAP DIMENSION	09/21/11	BMA
A	20044	RELEASED FOR PRODUCTION	7/1/11	BGL
REV	PCR NO	DESCRIPTION	DATE	BY

TITLE ULP12EEP1QSFCL1YELRED				
SCALE	DATE	DR	DWG	REV
1.5:1	7/1/2011	BGL	B800015	B

THE INFORMATION CONTAINED IN THIS DOCUMENT IS PROPRIETARY TO E-SWITCH AND IS NOT TO BE COPIED OR TRANSFERRED

X-ON Electronics

Largest Supplier of Electrical and Electronic Components

Click to view similar products for [Pushbutton Switches](#) category:

Click to view products by [E-Switch](#) manufacturer:

Other Similar products are found below :

[8940K2012](#) [LW1L-M1C10V-A](#) [LW1L-M1C70-A](#) [LW2L-A1C20M-GD](#) [LW2L-M1C20M-A](#) [60324L](#) [M22-D-R-GB0/K11](#) [M7E-HRN2](#)
[67021K512](#) [67081K512X](#) [701PB580](#) [7190K101](#) [7199K101](#) [810K12910](#) [810KSV30B](#) [MML21EA2ADK](#) [MML21KA3ABK](#)
[MML23KA3AC05K-001](#) [MML23KW3AA01W](#) [8418K2](#) [8442K3](#) [8450K1](#) [860K11911T01A](#) [861901](#) [861K11911T01A07](#)
[861K13810T00A14](#) [861K13911](#) [8646AB6X718UL](#) [8646ABUL](#) [9001KXRK](#) [907AYY100](#) [PMHD155A1](#) [95-313.000](#)
[9533CD4+U574+U4922](#) [95-414.000](#) [99-450.837](#) [99-453.837](#) [PV3H2B0NN-341](#) [1203MRA](#) [A22NZBGANGA](#) [A22NZBMMNGA](#)
[A22NZBNANGA](#) [A22NZMPATRA](#) [A2PMA1X03EC56](#) [A3A-5123-02](#) [A3A-7140](#) [A3A-7310](#) [A3A-7340](#) [A3U-TMW-A2C-5M](#) [A595](#)