

WS SERIES SNAP ACTION SWITCH

ANTI-VANDAL SWITCHES
 DETECTOR SWITCHES
 DIP SWITCHES
 KEYLOCK SWITCHES
 NAVIGATION SWITCHES
 PUSHBUTTON SWITCHES
 ROCKER SWITCHES
 ROTARY SWITCHES
 SLIDE SWITCHES
SNAP ACTION SWITCHES
 TACTILE SWITCHES
 TOGGLE SWITCHES
 CAP OPTIONS

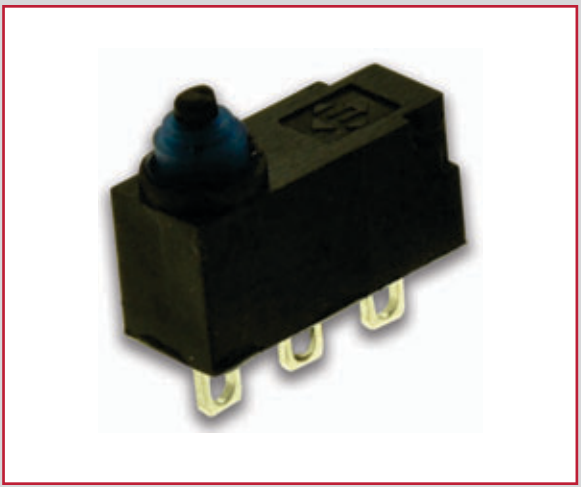

APPLICATIONS / MARKETS



RoHS

SPECIFICATIONS

Contact Rating: 01 = 1A @ 24VDC
 02 = 2A @ 12VDC
 03 = 0.1A @ 125VAC
Electrical Life: 10,000 Cycles
Mechanical Life: 1,000,000 Cycles
Contact Resistance: 100mΩ Max. Initial
Insulation Resistance: 100MΩ Min. @ 500VDC
Dielectric Strength: 600VAC
Operating/Storage Temperature: -25°C to 85°C
Moisture Protection: IP67
Contact Arrangement: SPDT
Actuation Force: See Table
Agency Approvals: UL

FEATURES & BENEFITS

- Plunger or lever actuator options
- Multiple termination options
- IP67 rated

PART NUMBER CONFIGURATOR

Series	Operating Temperature	Current Rating	Actuator	Operating Force	Termination	Circuit
<input type="text" value="WS"/>	<input type="text" value="085"/> - <input type="text" value="85C"/>	<input type="text" value="01"/> - 1A @24VDC <input type="text" value="02"/> - 2A @12VDC <input type="text" value="03"/> - 0.1A @125VAC	<input type="text" value="00"/> - Pin Plunger <input type="text" value="01"/> - 20mm Lever	<input type="text" value="F070"/> - 70 grams with 00 plunger <input type="text" value="F050"/> - 70 grams with 01 lever	<input type="text" value="P"/> - PCB Pins <input type="text" value="S"/> - Solderlug	<input type="text" value="A"/> - SPDT

Specifications subject to change without notice



E-SWITCH®

www.e-switch.com

800.867.2717

2

WS SERIES SNAP ACTION SWITCH

SOLDER LUG TERMINALS

Plunger Actuator

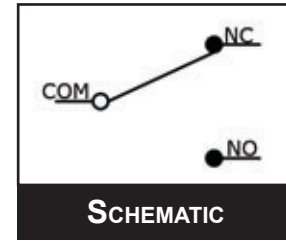
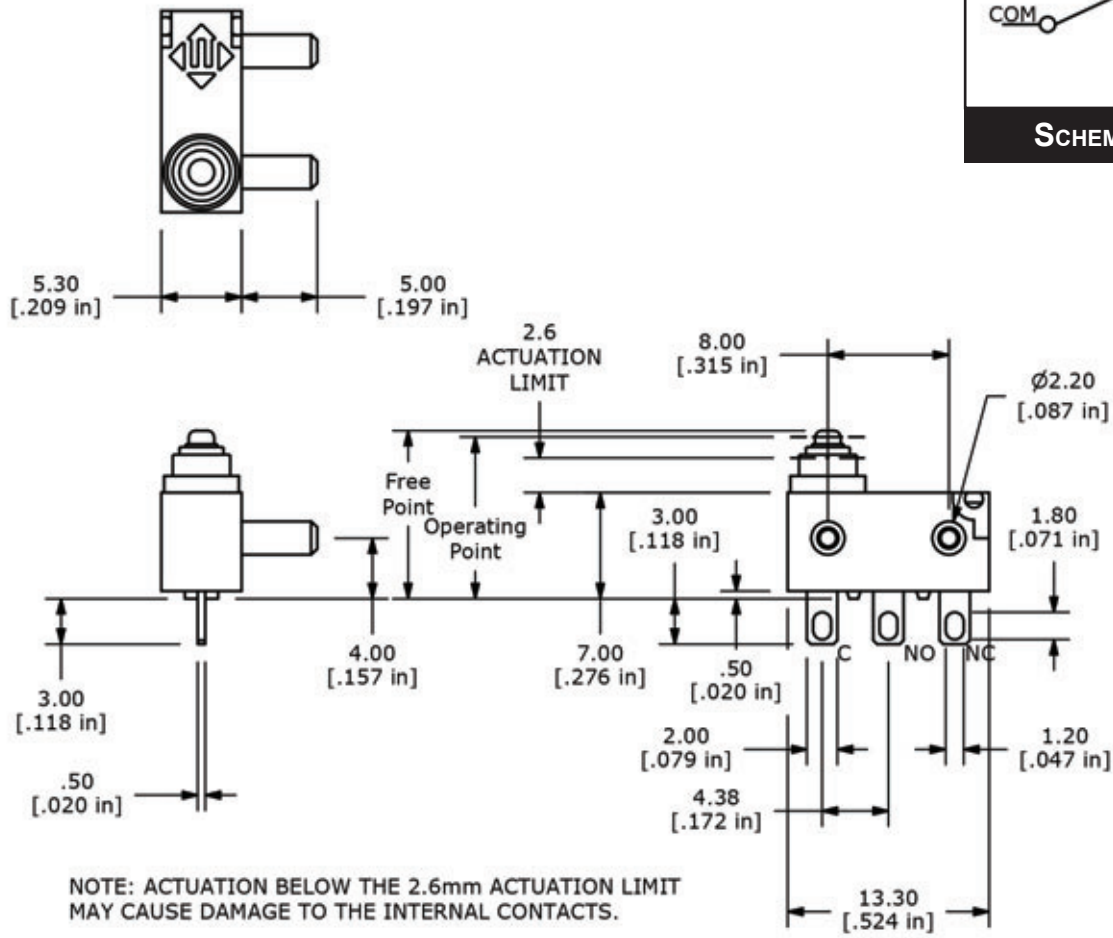

OPERATING POINT CHART		
ACTUATOR STYLE	FREE POINT	OPERATING POINT
00	11.5mm Max.	10.5±0.3mm
01	15.0mm Max.	13.4±0.8mm

NOTE: FOR WIRE LEAD TERMINATION MODELS, THE FREE POINT AND OPERATING POINT WOULD BE MEASURED FROM THE MOUNTING BOSSES. THIS WILL REDUCE THE ABOVE LISTED VALUES BY 4MM'S



WS SERIES SNAP ACTION SWITCH

SOLDER LUG TERMINALS

Lever Actuator

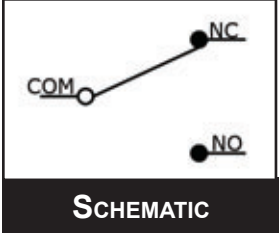
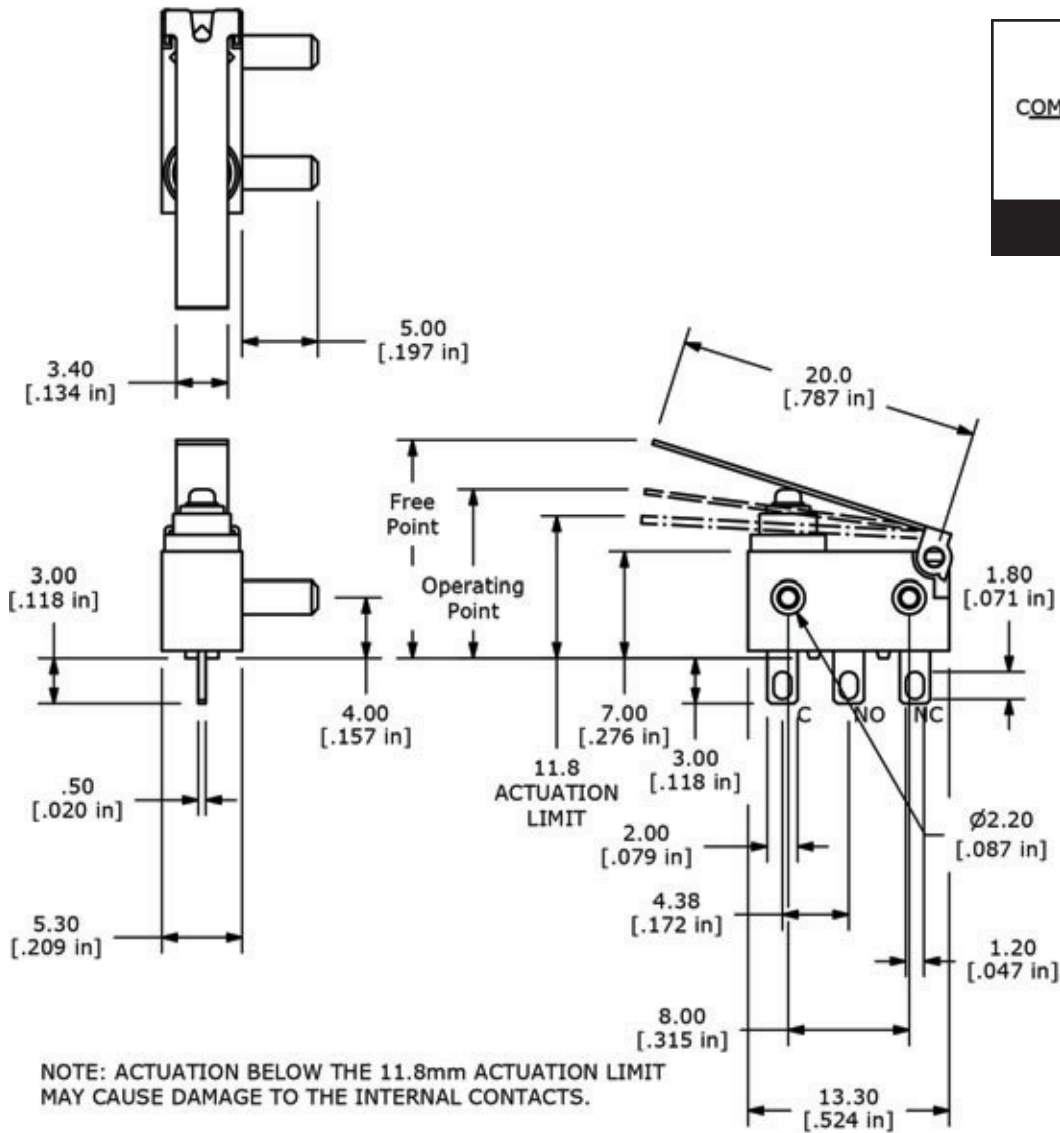

OPERATING POINT CHART		
ACTUATOR STYLE	FREE POINT	OPERATING POINT
00	11.5mm Max.	10.5±0.3mm
01	15.0mm Max.	13.4±0.8mm

NOTE: FOR WIRE LEAD TERMINATION MODELS, THE FREE POINT AND OPERATING POINT WOULD BE MEASURED FROM THE MOUNTING BOSSES. THIS WILL REDUCE THE ABOVE LISTED VALUES BY 4MM'S

- ANTI-VANDAL SWITCHES
- DETECTOR SWITCHES
- DIP SWITCHES
- KEYLOCK SWITCHES
- NAVIGATION SWITCHES
- PUSHBUTTON SWITCHES
- ROCKER SWITCHES
- ROTARY SWITCHES
- SLIDE SWITCHES
- SNAP ACTION SWITCHES
- TACTILE SWITCHES
- TOGGLE SWITCHES
- CAP OPTIONS



WS SERIES SNAP ACTION SWITCH

PCB PIN TERMINALS

Plunger Actuator

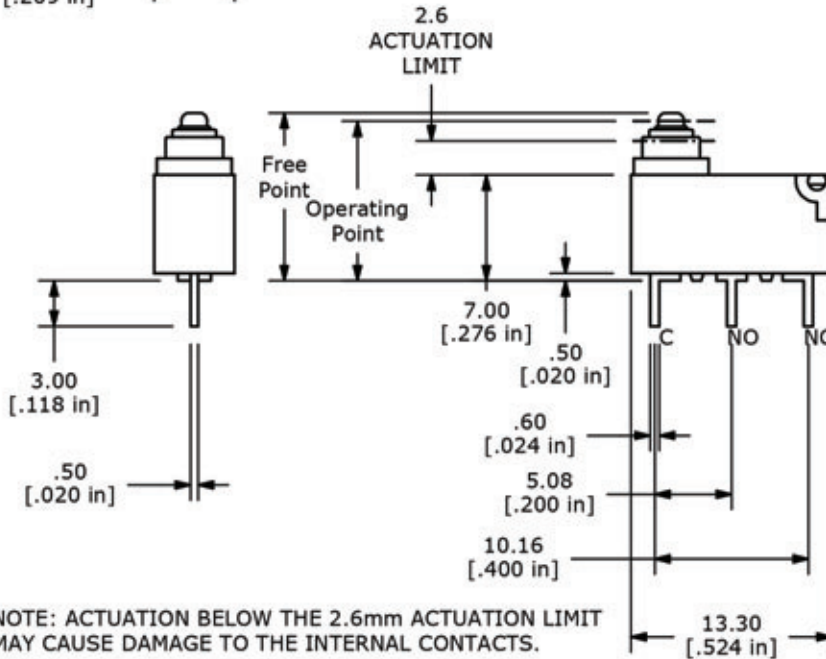

NOTE: ACTUATION BELOW THE 2.6mm ACTUATION LIMIT MAY CAUSE DAMAGE TO THE INTERNAL CONTACTS.

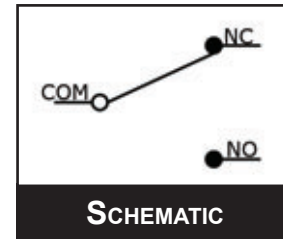

SCHEMATIC

OPERATING POINT CHART		
ACTUATOR STYLE	FREE POINT	OPERATING POINT
00	11.5mm Max.	10.5±0.3mm
01	15.0mm Max.	13.4±0.8mm

NOTE: FOR WIRE LEAD TERMINATION MODELS, THE FREE POINT AND OPERATING POINT WOULD BE MEASURED FROM THE MOUNTING BOSSES. THIS WILL REDUCE THE ABOVE LISTED VALUES BY 4MM'S

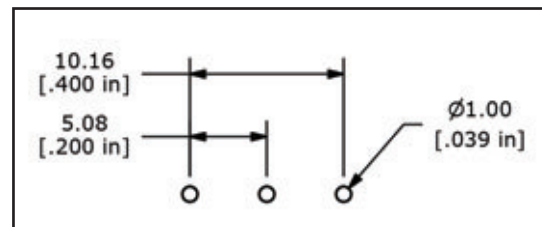

PCB LAYOUT



- ANTI-VANDAL SWITCHES
- DETECTOR SWITCHES
- DIP SWITCHES
- KEYLOCK SWITCHES
- NAVIGATION SWITCHES
- PUSHBUTTON SWITCHES
- ROCKER SWITCHES
- ROTARY SWITCHES
- SLIDE SWITCHES
- SNAP ACTION SWITCHES
- TACTILE SWITCHES
- TOGGLE SWITCHES
- CAP OPTIONS

X-ON Electronics

Largest Supplier of Electrical and Electronic Components

Click to view similar products for [Basic / Snap Action Switches](#) category:

Click to view products by [E-Switch](#) manufacturer:

Other Similar products are found below :

[5SM901-S12](#) [5SM9-S12N195](#) [01.098.1358.1](#) [602EN532](#) [602EN535-RB](#) [602HE5-RB1](#) [604HE162](#) [604HE223-6B](#) [624HE17-RB](#) [6HM82](#)
[6HM89](#) [6SE1](#) [6SX1-H58](#) [70500216](#) [70599106](#) [MBD5B1](#) [MBH2731](#) [73-316-0012](#) [EXD-AR20](#) [79211923](#) [79218589](#) [7AS12](#)
[MIL30126AB6BBMD4A12XAU](#) [ML-1155](#) [ML-1376](#) [831010C3.0](#) [831090C2.EL](#) [83131904](#) [84212012](#) [8AS239](#) [8HM73-3](#) [8SX26-H33](#)
[914CE1-6G](#) [PL-100](#) [11SM1077-H4](#) [11SM1077-H58](#) [11SM1-TN107](#) [11SM405](#) [11SM8423-H2](#) [11SX37-T](#) [11SX48-H58](#) [11SM2442-T](#)
[11SM76-T](#) [11SM77-H58](#) [11SM77-T](#) [11SM863-T](#) [11SM866](#) [A7CN-1M-1-LEFT](#) [A831700C7.0](#) [121EN187-R](#)