

## Description

Tease-free, trip-free, snap action mechanism. Designed for snap-in panel mounting utilising round hole or industry standard fuse-holder cut-out dimensions. Featuring an ergonomically styled two colour actuator with indicator band clearly showing the tripped/OFF position. Approved to CBE standard EN 60934 (IEC 60934): S-type TO CBE

## Typical applications

Motors, transformers, solenoids, extra low voltage systems, household and office machines, instrumentation, marine applications, mobile homes.

## Features

- Single pole thermal circuit breaker/switch combination
- Voltage rating: AC 250 V, DC 50 V
- Current ratings: 0.05...16 A
- Approvals: VDE, UL, CSA
- Accessories: Plastic cap to protect against dust and water in actuator and terminal area (IP64)



## Your benefits

- Cost and space savings because one component unites the functions of ON/OFF switch and overload protection
- Time savings through quick trouble-shooting and fast and easy reset by push button
- Maximum machine and equipment uptime through perfectly matched overload protection protection and quick reset

## Preferred types – for more details on all configurations please see order numbering code

Preferred types are E-T-A products most frequently used by E-T-A customers. We manufacture E-T-A preferred types in particularly high volumes.

Preferred types	Short description	Preferred ratings (A)							
		1	2	3	5	6	8	10	16
1110-F112-P1M1-	panel thickness 0.8...1.6 mm	•	•	•	•	•	•	•	•
1110-F212-P1M1-	panel thickness 1.8...3 mm	•	•	•	•	•	•	•	•

## Approvals



## Conformities



## Technical data

For further details please see: [www.e-t-a.de/ti\\_e](http://www.e-t-a.de/ti_e)

Voltage rating	AC 250 V; DC 50 V		
Current rating	0.05...16 A		
<b>I<sub>n</sub></b>	<b>operations</b>	<b>U<sub>n</sub></b>	<b>I</b>
0.05...10 A	10000	AC 250 V	1xln
0.05...10 A	10000	DC 28 V	1xln
0.05...10 A	6000	DC 50 V	1xln
12...16 A	2000	DC 50 V	1xln
Ambient temperature	-20...60 °C (-4...+140 °F)		
Insulation co-ordination (IEC 60664)	2.5 kV/2 reinforced insulation in operating area		
Dielectric strength	<b>operating area</b> test voltage AC 3 000 V		
Insulation resistance	> 100 MΩ (DC 500 V)		
Interrupting capacity I <sub>cn</sub>	AC 250 V:	0.05...10 A	8 x I <sub>N</sub>
	DC 50 V:	0.05...6 A	10 x I <sub>N</sub>
		7...16 A	130 A
	DC 28 V:	7...10 A	200 A

## Technical data

Interrupting capacity (UL 1077)	<b>I<sub>N</sub></b>	<b>U<sub>N</sub></b>	
	0.05...6 A	AC 250V	1 000 A, C, 1
	7...16 A	AC 125V	1 000 A, U, 1
	0.05...16 A	DC 50V	1 000 A, C, 1
<b>Degree of protection</b> (IEC 60529)			
operating area	IP40		
terminal area	with protective cover IP64 IP00 with protective cover IP64		
Vibration	8 g (57-500 Hz) ± 0.61 mm (10-57 Hz), to IEC 60068-2-6, test Fc, 10 frequency cycles/axis		
Shock	30 g (11 ms) to IEC 60068-2-27, test Ea		
Corrosion	96 hours at 5 % salt mist, to IEC 60068-2-11, test Ka		
Humidity	240 hours at 95 % RH to IEC 60068-2-78, test Cab		
Mass	approx. 12 g		

## Preferred types

Preferred types are E-T-A products most frequently used by E-T-A customers. We manufacture E-T-A preferred types in particularly high volumes.

Preferred types	Short description	Preferred ratings (A)							
		1	2	3	5	6	8	10	16
1110-F112-P1M1-	panel thickness 0.8...1.6 mm	•	•	•	•	•	•	•	•
1110-F212-P1M1-	panel thickness 1.8...3 mm	•	•	•	•	•	•	•	•

## Ordering information

<b>Type No.</b>	
1110	snap in panel mounting
	<b>Mounting</b>
	<b>F1</b> panel thickness 0.8...1.6 mm (.031 -.063 in)
	<b>F2</b> panel thickness 1.8...3 mm (.071-.118 in)
	<b>Number of poles</b>
	<b>1</b> 1-pole protected
	<b>Actuator style</b>
	<b>2</b> black push button/white indicator ring, push-push function
	<b>Terminal design</b>
	<b>P1</b> blade terminals A6.3-0.8 (QC .250)
	<b>Characteristic curve</b>
	<b>M1</b> medium delay
	<b>Current ratings</b>
	<b>0.05...16A</b>
1110 - F1 1 2 - P1 M1 - 0.05 A = ordering example	

Please be informed that we have minimum ordering quantities to be observed.

## Custom designed versions

Looking for a version you cannot find in our ordering number code? Please get in touch. We will be pleased to find a solution for you.

## Standard current ratings and typical internal resistance values

Current rating (A)	Internal resistance (Ω)	Current rating (A)	Internal resistance (Ω)
0.05	442	2.5	0.19
0.1	110	3	0.12
0.2	27.8	3.5	0.09
0.3	12.4	4	0.07
0.4	7.0	5	0.05
0.5	4.5	6	0.04
0.6	3.1	7	≤ 0.02
0.7	2.3	8	≤ 0.02
1	1.1	10	≤ 0.02
1.5	0.41	12	≤ 0.02
1.8	0.38	15	≤ 0.02
2	0.25	16	≤ 0.02

This is a metric design and millimeter dimensions take precedence ( $\frac{\text{mm}}{\text{inch}}$ )

All dimensions without tolerances are for reference only. In the interest of improved design, performance and cost effectiveness the right to make changes in these specifications without notice is reserved. Product markings may not be exactly as the ordering codes. Errors and omissions excepted.

## Approvals

Authority	Standard	Rated voltage	Current ratings	Approval logo
VDE	IEC/EN 60934	AC 250 V DC 50 V	0.05 A...10 A 0.05 A...16 A	
UL*	UL 1077 C22.2 No 235	AC 250 V AC 125 V DC 50 V	0.05 A...6 A 7 A...16 A 0.05 A...16 A	
CSA*	C22.2 No 235	AC 250 V AC 125 V DC 50 V	0.05 A...6 A 7 A...16 A 0.05 A...16 A	

\*TC1, OLO

## Dimensions

### 1110-F1.. / -F2..

When installing the circuit breaker apply pressure on bezel only.

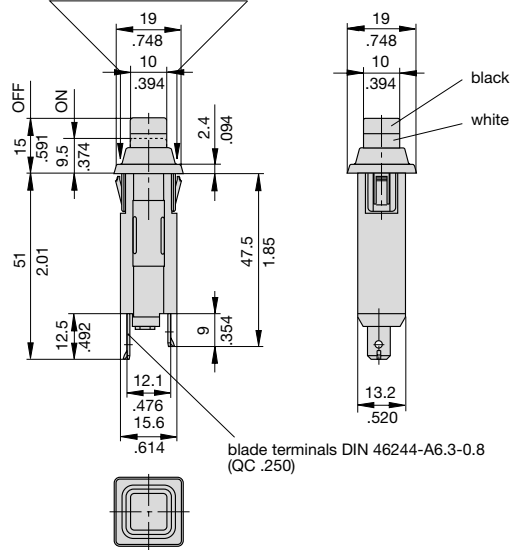

### Panel cut out 1110-F1...-P1M1...A

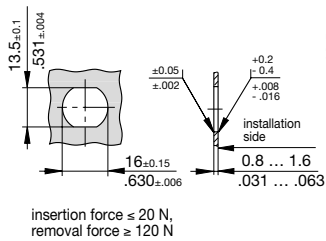

### 1110-F2...-P1M1...A

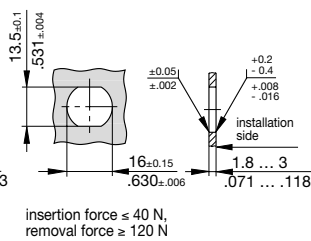

## Installation drawing

When installing the circuit breaker apply pressure on bezel only.

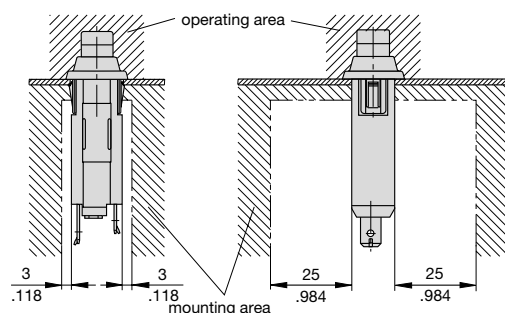

## Internal connection diagram

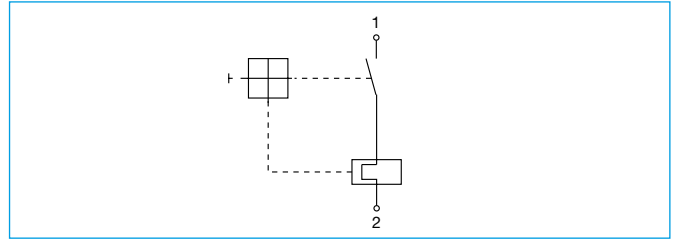

## Typical time/current characteristics at +23 °C/+73.4 °F

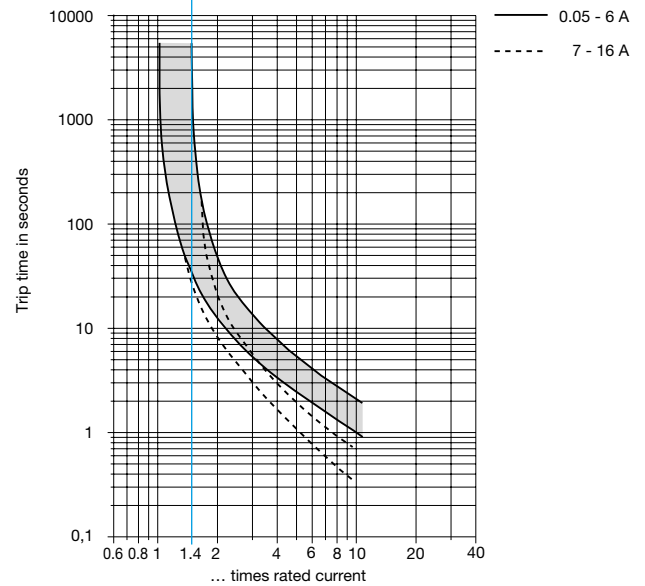

The time/current characteristic curve depends on the ambient temperature prevailing. In order to eliminate nuisance tripping, please multiply the circuit breaker current ratings by the derating factor shown below.

Ambient temperature °F	-4	+14	+32	+73.4	+104	+122	+140
°C	-20	-10	0	+23	+40	+50	+60
Derating factor	0.76	0.84	0.92	1	1.08	1.16	1.24

## Accessories – Water splash covers (transparent)

### Push button splash cover transparent Y 304 745 01 (IP64)

When using splash cover please note that the max. panel thickness is reduced by 0.5 mm/0.02 in.

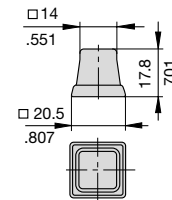

### Terminal shroud Y 305 602 01 (IP64)

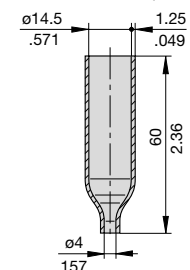

## X-ON Electronics

Largest Supplier of Electrical and Electronic Components

*Click to view similar products for [Circuit Breakers](#) category:*

*Click to view products by [ETA](#) manufacturer:*

Other Similar products are found below :

[LUGZX66-1-61-20.0-44](#) [M39019/01-201S](#) [M39019/01-221](#) [M39019/01-323](#) [M39019/01-333](#) [M39019/01-336](#) [M39019/02-248](#) [M39019/02-311](#) [M39019/02-316](#) [M39019/04-249S](#) [M39019/05-246S](#) [M39019/06-254S](#) [M55629/1-016](#) [M55629/1-018](#) [M55629/1-021](#) [M55629/1-033](#) [M55629/1-036](#) [M55629/1-046](#) [M55629/1-048](#) [M55629/1-058](#) [M55629/1-067](#) [M55629/1-070](#) [M55629/1-079](#) [M55629/1-084](#) [M55629/1-085](#) [M55629/1-101](#) [M55629/1-109](#) [M55629/11-102](#) [M55629/1-120](#) [M55629/12-045](#) [M55629/12-046](#) [M55629/1-330](#) [M55629/1-366](#) [M55629/1-387](#) [M55629/1-401](#) [M55629/1-450](#) [M55629/2-022](#) [M55629/2-030](#) [M55629/2-072](#) [M55629/2-082](#) [M55629/2-099](#) [M55629/2-101](#) [M55629/2-102](#) [M55629/21-BM-BM](#) [M55629/21-HM-HM](#) [M55629/21-NS-NS](#) [M55629/22-NR-NR-NR](#) [M55629/22-RS-RS-RS](#) [M55629/2-347](#) [M55629/2-401](#)