

Description

Miniaturised double pole thermal circuit breaker with push-to-reset tease-free, trip-free, snap action mechanism (R-type TO CBE to EN 60934). Threadneck panel mounting. Suitable for line and neutral switching - the thermal actuator operating on one pole simultaneously opens both poles under overload conditions. Approved to CBE standard EN 60934 (IEC 60934).

Typical applications

Motors, transformers, solenoids, hand-held machines and appliances. Especially suited to AC duties where the correct orientation of line/neutral is not known/cannot be guaranteed.

Ordering information

Type No.

1140	double pole threadneck panel mounting
Mounting	
G1	threadneck panel mounting 3/8-27UNS, with hex nut and knurled nut (hardware bulk shipped with 5 pcs plus)
Number of poles	
5	double pole, 1-pole protected
Actuator style	
1	black push button
Terminal design	
P7	blade terminals DIN 46244-C (QC 2x.110)
Characteristic curve	
M1	medium delay
Current ratings	
0,05...16 A	
1140 - G1 5 1 - P7 M1 - 16 A ordering example	

Preferred types

Preferred types	Standard current ratings (A)											
	0.5	1	1.5	2	3	4	5	6	8	10	12	15
1140-G151-P7M1	x	x	x	x	x	x	x	x	x	x	x	x

Standard current ratings and typical internal resistance values

Current rating (A)	Internal resistance (Ω)	Current rating (A)	Internal resistance (Ω)
0.05	345	1.8	0.3
0.06	240	2	0.3
0.08	142	2.5	0.2
0.1	88	3	0.1
0.2	24	3.5	0.08
0.3	9.9	4	0.07
0.4	5.9	5	0.05
0.5	3.7	6	0.04
0.6	2.2	7	< 0.02
0.7	1.9	8	< 0.02
0.8	1.4	10	< 0.02
1	0.9	12	< 0.02
1.2	0.6	15	< 0.02
1.5	0.5	16	< 0.02



1140-G15

Technical data

For further details please see chapter: Technical Information

Voltage rating	AC 240 V; DC 48 V (UL: AC 250 V; DC 50 V)		
Current ratings	0.05...16 A		
Typical life	AC + DC		
	0.05...3 A	300 operations at 2 x I _N , inductive	
	3.5...8 A	200 operations at 2 x I _N , inductive	
	9...16 A	100 operations at 2 x I _N , inductive	
Ambient temperature	-20...+60 °C (-4...+140 °F) T 60		
Insulation co-ordination (IEC 60664 and 60664 A)	rated impulse withstand voltage 2.5 kV	pollution degree 2	reinforced insulation in operating area
Dielectric strength (IEC 60664 and 60664A)	test voltage AC 3,000 V	operating area pole/pole	AC 1,500 V
Insulation resistance	> 100 MΩ (DC 500 V)		
Interrupting capacity I _{cn}	0.05...3 A 3.5...8 A 9...16 A	6 x I _N 8 x I _N 120 A	
Interrupting capacity (UL 1077)	I _N 0.05...16 A 0.05...16 A	U _N DC 50 V AC 250 V	2,000 A 2,000 A
Degree of protection (IEC 60529/DIN 40 050)	operating area IP40 terminal area IP00		
Vibration	10 g (57-500 Hz) ± 0.76 mm (10-57 Hz), to IEC 60068-2-6, test Fc, 10 frequency cycles/axis		
Shock	25 g (11 ms) to IEC 60068-2-27, test Ea		
Corrosion	96 hours at 5 % salt mist, to IEC 60068-2-11, test Ka		
Humidity	240 hours at 95 % RH to IEC 60068-2-78, test Cab		
Mass	approx. 13 g		

Approvals

Authority	Standard	Voltage ratings	Current ratings
VDE	IEC/EN 60934	AC 240 V DC 48 V	0.05 A...16 A 0.05 A...16 A
UL	UL 1077	AC 250 V DC 50 V	0.05 A...16 A 0.05 A...16 A
CSA	C22.2 No 235	AC 250 V DC 50 V	0.05 A...16 A 0.05 A...16 A

Dimensions

1140-G15...

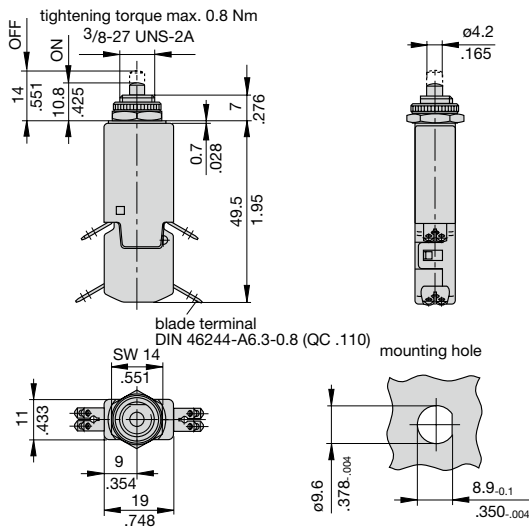

Internal connection diagram

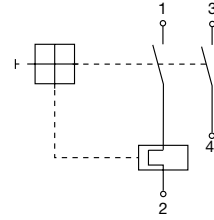

Typical time/current characteristics at +23 °C/+73.4 °F

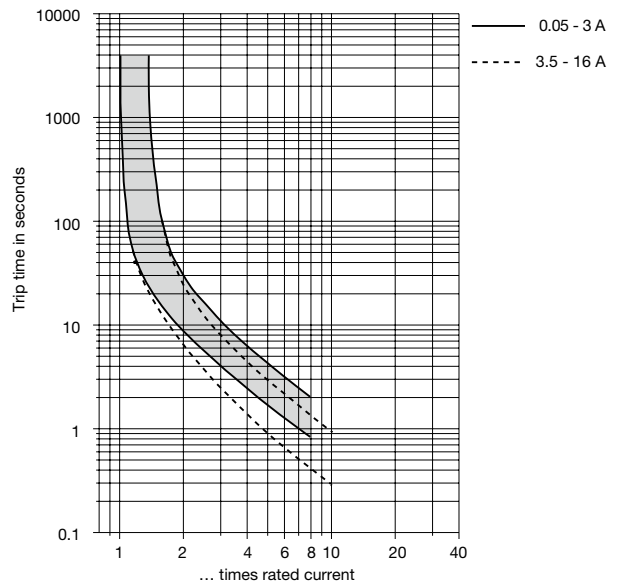

The time/current characteristic curve depends on the ambient temperature prevailing. In order to eliminate nuisance tripping, please multiply the circuit breaker current ratings by the derating factor shown below. See also section Technical information.

Ambient temperature °F	-4	+14	+32	+73.4	+104	+122	+140
°C	-20	-10	0	+23	+40	+50	+60
Derating factor	0.76	0.84	0.92	1	1.08	1.16	1.24

Installation drawing

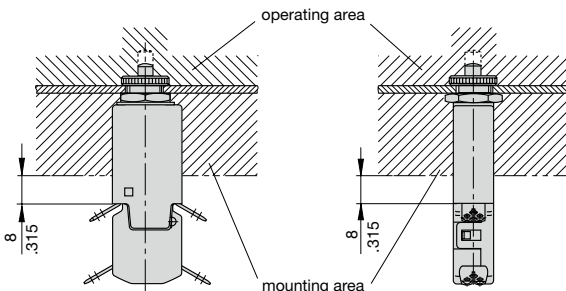

Accessories

Water splash cover/knurled nut assembly, transparent X 201 285 01 (IP64)

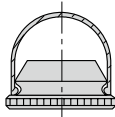

Knurled nut 3/8" plastic (standard) Y 307 117 02

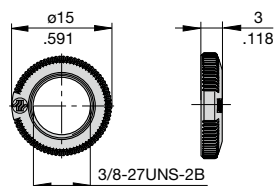

Hex nut 3/8" nickel-plated brass Y 300 192 01

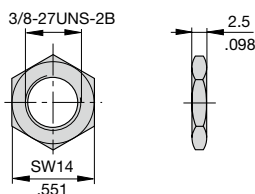

This is a metric design and millimeter dimensions take precedence (mm/inch)

All dimensions without tolerances are for reference only. In the interest of improved design, performance and cost effectiveness the right to make changes in these specifications without notice is reserved. Product markings may not be exactly as the ordering codes. Errors and omissions excepted.

X-ON Electronics

Largest Supplier of Electrical and Electronic Components

Click to view similar products for [Circuit Breakers](#) category:

Click to view products by [ETA](#) manufacturer:

Other Similar products are found below :

[LUGZX66-1-61-20.0-44](#) [M39019/01-201S](#) [M39019/01-221](#) [M39019/01-323](#) [M39019/01-333](#) [M39019/01-336](#) [M39019/02-248](#) [M39019/02-311](#) [M39019/02-316](#) [M39019/04-249S](#) [M39019/05-246S](#) [M39019/06-254S](#) [M55629/1-016](#) [M55629/1-018](#) [M55629/1-021](#) [M55629/1-033](#) [M55629/1-036](#) [M55629/1-046](#) [M55629/1-048](#) [M55629/1-058](#) [M55629/1-067](#) [M55629/1-070](#) [M55629/1-079](#) [M55629/1-084](#) [M55629/1-085](#) [M55629/1-101](#) [M55629/1-109](#) [M55629/11-102](#) [M55629/1-120](#) [M55629/12-045](#) [M55629/12-046](#) [M55629/1-330](#) [M55629/1-366](#) [M55629/1-387](#) [M55629/1-401](#) [M55629/1-450](#) [M55629/2-022](#) [M55629/2-030](#) [M55629/2-072](#) [M55629/2-082](#) [M55629/2-099](#) [M55629/2-101](#) [M55629/2-102](#) [M55629/21-BM-BM](#) [M55629/21-HM-HM](#) [M55629/21-NS-NS](#) [M55629/22-NR-NR-NR](#) [M55629/22-RS-RS-RS](#) [M55629/2-347](#) [M55629/2-401](#)