

Description

Single/double pole compact magnetic/hydraulic or magnetic circuit breaker with ratings of 0.02 to 30 A. Upon request, the 8330 in combination with the C14 appliance inlet is also available as completely assembled power entry module (optionally with or without line filter).

Typical applications

Various applications in telecom/datacom, transportation, marine, generators, power supplies and medical equipment.

Features and benefits

- High performance hydraulic-magnetic breaker with compact and space saving design – 35 x 33 mm (1.4 x 1.3 in) for 30 A double-pole variant
- Single or double pole series trip variants. With double pole variant both poles are protected – in case of overcurrent on at least one pole both lines are safely disconnected (mandatory in many medical equipment applications)
- Different mounting methods like flange, threadneck or snap-in together with a wide variety of actuators provide high flexibility to meet individual device design needs
- Several tripping curves with different time delays: fast magnetic-only with instantaneous trip or various magnetic-hydraulic tripping curves for tailored device protection
- Trip-free mechanism – ensures reliable disconnection of the circuit even with blocked actuator
- Low temperature sensitivity at rated load
- Approvals for CBE standards EN60934, UL1077 and CSA C22.2 No. 235

Technical data

Voltage rating	AC 250 V, AC 125 V (50/60 Hz), DC 80 V
Current rating range	0.02...30 A (see also ordering information table for increments and rupture capacity specifications)
Auxiliary switch rating	SPDT (single pole, double throw); 7 A AC 250 V, 7 A (Res) DC 28 V, 4 A (Ind.) DC 28 V, 0.25 A, DC 80 V (Res) (silver contacts), 0.1 A, AC 125 V (gold contacts)
Insulation resistance	Minimum of 100 MΩ at DC 500 V
Dielectric strength	UL, CSA 1500 V, 50/60 Hz for one minute between all electrically isolated terminals. 8330 series circuit breakers comply with reinforced insulation requirements for the separation between hazardous voltage and operator accessible surfaces, as e.g. per standards IEC 60934, IEC 62368-1



Approvals



The current data sheet as well as other relevant documents are available on our website: www.e-t-a.com

Compliance



Technical data

Typical life	10 000 operations with rated current I_N
Degree of protection (IEC 60529/DIN 40050)	Operating area IP40, terminal area IP00
Ambient Temperature ⁽¹⁾	-40°C to 85°C (-40°F to 185°F)
Thermal Shock ⁽¹⁾	Method 107D, Condition A (five cycles @ -55°C to +25°C to +85°C to +25°C).
Vibration ⁽¹⁾	Withstands 0.060" excursion from 10-55 Hz, and 10 Gs 55-500 Hz, at rated current per Method 204C, Test Condition A. Instantaneous curves tested at 80% of rated current.
Shock ⁽¹⁾	Withstands 100 Gs, 6 ms, sawtooth while carrying rated current per Method 213, Cond. I. Instantaneous curves tested at 80% of rated current.
Corrosion ⁽¹⁾	101, Condition A (90-95% RH @ 5% NaCl Solution, 96 hrs).
Humidity ⁽¹⁾	Method 106D, i.e., ten 24-hour cycles @ + 25°C to +65°C, 80-98% RH.
Mass	approx. 30 g per pole (depending on version)

⁽¹⁾ Designed in accordance with requirements of specification MIL PRF-55629 & MIL-STD-202G

Resistance per Pole Values

Resistance, Impedance

Values from Line to Load Terminal - based on Series Trip Circuit Breaker.

Current (A)	Tolerance (%)
0.1 - 20.0	± 25
20.1 - 50.0	± 30

Resistance per pole values from line to Load Terminals (Values Based on Series Trip Circuit Breaker)

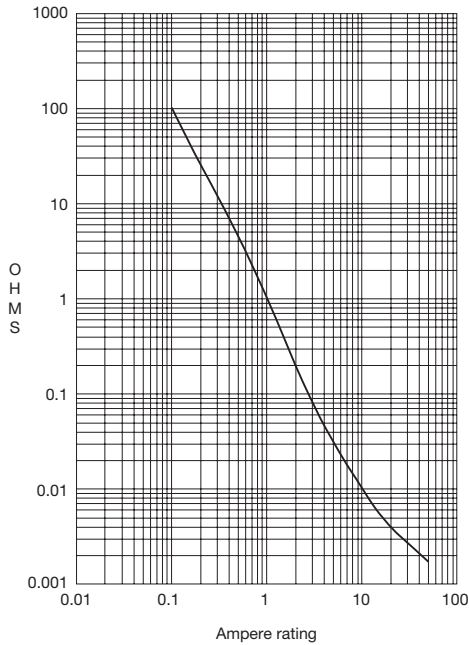

Pulse Tolerance

60 Hz 1/2 Cycle Inrush Pulse Tolerance

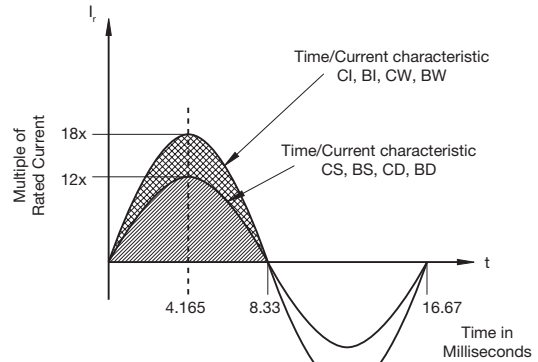

50 Hz 1/2 Cycle Inrush Pulse Tolerance

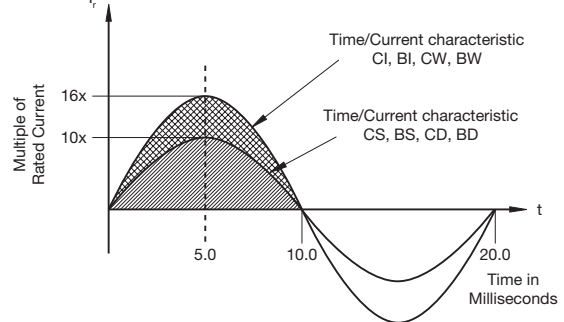

Rupture capacity

Device	Voltage		Current Rating [A]	No. of Poles	Short Circuit Capacity [A]				Application Codes	
	Max Rating [V]	Frequency [Hz]			UL/CSA		TÜV (EN60934)		UL	CSA
					With Backup Fuse	Without Backup Fuse	With Backup Fuse: I _{nc}	Without Backup Fuse: I _{cn}		
8330 series	32	DC	0.02 - 15	1	---	1000	3000	500	TC1, 2, OL1, U1	TC1, 2, OL1, U1
			15.1 - 25	1	---	1000	---	---	TC1, 2, OL0, U1	TC1, 2, OL0, U1
	50 ⁽²⁾	DC	0.02 - 7.5	1	---	1000	---	---	TC1, 2, OL0, U1	TC1, 2, OL0, U1
			0.02 - 15	2	---	1000	3000	500	TC1, 2, OL1, U1	TC1, 2, OL1, U1
	65	DC	15.1 - 25	2	---	1000	---	---	TC1, 2, OL0, U1	TC1, 2, OL0, U1
			0.02 - 15	2	5000	---	3000	500	TC1, 2, OL1, C1	TC1, 2, OL1, C1
	65 ⁽³⁾	DC	15.1 - 30	2	5000	---	---	---	TC1, 2, OL0, C1	TC1, 2, OL0, C1
			0.02 - 15	1	---	500	3000	600	TC1, 2, OL1, U1	TC1, 2, OL1, U1
	80 ⁽¹⁾⁽²⁾	DC	15.1 - 30	1	---	500	3000	600	TC1, 2, OL0, U1	TC1, 2, OL0, U1
			0.02 - 15	1	---	1000	3000	500	TC1, 2, OL0, U1	TC1, 2, OL0, U1
	125	50/60	0.02 - 15	1	---	1000	3000	500	TC1, 2, OL0, U1	TC1, 2, OL0, U1
	250	50/60	0.02 - 12	1	---	1000	3000	500	TC1, 2, OL1, U1	TC1, 2, OL1, U1
0.02 - 20			2	---	1000	3000	500	TC1, 2, OL1, U1	TC1, 2, OL1, U1	

(1) Polarity Sensitive
 (2) Available only with Special Catalog Number. Consult E-T-A.
 (3) Requires Branch Circuit Backup with a UL Listed type K-5 or RK-5 fuse rated 30 Amps maximum

This is a metric design and millimeter dimensions take precedence (mm/inch).

Ordering information

Type No.	8330 circuit breaker
Mounting	
Flange	
F	flange, black
N	flange, white
Q	flange, grey
Threadneck	
G	threadneck, black
Snap-in	
M	snap-in, black
Size	
G	panel thickness 1 - 2.5 mm (flange)
M	1/2"-32 threadneck for paddle and baton variants
N	3/8"-32 threadneck for push-pull and push-to-reset variants
S	standard fuseholder cut out for mounting -M only
Number of poles	
1	single pole switching, single pole protected
2	double pole switching, double pole protected
Panel hardware (bulk) (1)	
Hex nut and knurled nut	
E	1 hex, 1 knurled (Ni), threadneck only
F	1 hex, 1 knurled (Ni), legend plate, threadneck only
G	1 hex, 1 knurled (Ni), locking ring
H	1 hex, 1 knurled (Ni), locking ring, legend plate, threadneck only
J	1 hex, 1 knurled (black)
K	1 hex, 1 knurled (black), legend plate
L	1 hex, 1 knurled (black), locking ring
M	1 hex, 1 knurled (black), locking ring, legend plate
Hex nut and knurled nut w/ collar	
N	1 hex, 1 knurled with collar (Ni), threadneck only
P	1 hex, 1 knurled with collar (Ni), legend plate, threadneck only
Q	1 hex, 1 knurled with collar (Ni), locking ring
R	1 hex, 1 knurled with collar (Ni), locking ring, legend plate, threadneck only
V	1 hex, 1 knurled with collar (black)
W	1 hex, 1 knurled with collar (black), legend plate
X	1 hex, 1 knurled with collar (black), locking ring
Y	1 hex, 1 knurled with collar (black), locking ring, legend plate
No additional panel hardware (threadneck or all rocker variants)	
0	without (choose when having rocker, with threadneck: 1 hex nut only)
9	rocker guard
Terminal design	
H	screw terminal, 8-32, back connected
J	screw terminal, 8-32, with upturned lugs
P	blade terminal 6.3 mm
W	push-in stud
X	screw terminal, 8-32 (bus type) (2)
Actuator configuration	
Rocker (3)	
E	two colour r., angled, indicate ON, (legend vertical or without) (4)
F	two colour r., angled, Indicate ON, (legend horizontal) (4)
G	two colour r., angled, Indicate OFF, (legend vertical or without) (4)
H	two colour r., angled, Indicate OFF, (legend horizontal) (4)
K	single colour r., flat, illuminated, (legend vertical or without)
L	single colour r., flat, illuminated, (legend horizontal)
R	single colour r., angled, (legend vertical or without)
S	single colour r., angled, (legend horizontal)
T	single colour r., flat, (legend vertical or without)
U	single colour r., flat, (legend horizontal)
W	single colour r., angled, illuminated (legend vertical or without)

8330- F G 1 0- P R ...	ordering example
X	single colour r., angled, illuminated (legend horizontal)
Paddle/Baton	
B	paddle, without legend plate
C	baton, without legend plate
M	paddle, legend plate ON-OFF vertical (2)
N	paddle, legend plate ON-OFF horizontal (2)
P	paddle, legend plate I-0 vertical
Q	paddle, legend plate I-0 horizontal
1	baton, legend plate ON-OFF vertical (2)
2	baton, legend plate ON-OFF horizontal (2)
3	baton, legend plate I-0 vertical
4	baton, legend plate I-0 horizontal
Push-Pull and Push-to-reset	
D	push to reset, no button marking
Z	push-pull, no marking
5	push-pull, rated Amps horizontal
6	push-pull, rated Amps Line Side Down
7	push pull, rated Amps Line Side Up
Time/current characteristics (5) (6) (7) (11)	
BD	AC/DC medium delay
BI	AC or DC medium delay, hi-inrush (16x/18x)
BS	AC or DC medium delay
BW	AC/DC medium delay, hi-inrush (16x/18x)
CD	AC/DC short delay
CI	AC or DC short delay, hi-inrush (16x/18x)
CS	AC or DC short delay
CW	AC/DC short delay, hi-inrush (16x/18x)
OP	instantaneous
Actuator colour and marking details (8)	
Rocker not illuminated (15)	
A	green I-O ON-OFF
B	green I-O
C	white I-O
D	black I-O
E	blue I-O
F	gray I-O
G	yellow I-O
H	red I-O
J	orange I-O
K	white I-O ON-OFF
L	black I-O ON-OFF
M	green ON-OFF
N	white ON-OFF
P	black ON-OFF
Q	blue ON-OFF
R	gray ON-OFF
S	yellow ON-OFF
T	red ON-OFF
U	orange ON-OFF
V	blue I-O ON-OFF
W	gray I-O ON-OFF
X	yellow I-O ON-OFF
Y	red I-O ON-OFF
Z	orange I-O ON-OFF
Rocker illuminated (14) (15)	
T	clear I-O ON-OFF
U	red transparent I-O ON-OFF
V	green transparent I-O ON-OFF
W	amber transparent I-O ON-OFF
X	smoke gray transparent I-O ON-OFF
Y	white translucent I-O ON-OFF
Paddle, baton, push button, push-pull retractable part and rocker w/o legend	
1	green
2	white
3	black
4	blue
6	yellow
7	red
8	orange
8330- F G 1 0- P R BS- L ...	ordering example



Ordering information

8330- F G 1 0- P R BS- L ... ordering example

- Illumination voltage (12)**
- A 120 V, 250 V, neon ⁽⁹⁾
- B 120 V, 250 V, green, neon ⁽⁹⁾
- C LED red ⁽⁹⁾
- D LED green ⁽⁹⁾
- E LED amber ⁽⁹⁾
- X no illumination
- Auxiliary contacts (13)**
- A without auxiliary contacts
- J 1 changeover, 1st pole, .06 dia solder turret, Ag
- K 1 changeover 1st pole, .058 dia round QC, Ag ⁽²⁾
- L 1 changeover, 1st pole, .06 dia solder turret, Au
- M 1 changeover, 1st pole, .058 dia round QC Au ⁽²⁾
- Internal circuit**
- B series trip
- Not used**
- 00
- Frequency**
- M AC/DC
- 4 AC
- 9 DC
- Current rating**
- 0.02-30 A (10)
- Approvals**
- C UL1077, CSA
- E UL1077, CSA, TÜV

8330- F G 1 0- P R BS- L X A B 00 4 30A E ordering example

- (1) Please choose actuator with legend plate respectively according to "Actuator configuration"
- (2) no TÜV approval
- (3) For rocker w/o legend select desired single colour at „Actuator colour and marking details/Rocker w/o legend“
- (4) Two colour rocker: rocker main colour is always flange colour, highlighted part of rocker can be selected according „Actuator colour and marking details/rocker not illuminated“
- (5) AC = 50/60 Hz
- (6) Choose AC, DC or AC/DC at "Frequency" respectively
- (7) For definition of hi-inrush see explanation at section Pulse Tolerance in this datasheet
- (8) I-O ON-OFF means both legends on the rocker (dual legend)
- (9) External resistor necessary
- (10) TÜV approval for current rating higher than 15 A only available for 2-pole version, max. current rating is 20 A
- (11) OP, CD, BD, CW and BW in combination with „M“ frequency not available as 30 A version
- (12) With illumination: rocker is always illuminated, independent of the switching status
- (13) One auxiliary contact per pole. Regarding the 2-pole version of the 8330, the auxiliary contact is connected to pole 1. Not available with one-pole illuminated 8330 or 8330 with push-in stud or screw terminals
- (14) Colour of the ill. rocker with LED/neon bulb clear, smoke gr. transp., whi. semi-transp. or colour of the LED/neon bulb
- (15) 8330 with TÜV approval must be marked with I-O or I-O ON-OFF. 8330 with two-colour rocker only configurable with marking.

Available current ratings

0.02	0.025	0.030	0.035	0.040	0.045	0.050	0.055	0.060
0.065	0.070	0.075	0.080	0.085	0.090	0.095	0.10	0.15
0.20	0.25	0.30	0.35	0.40	0.45	0.50	0.55	0.60
0.65	0.70	0.75	0.80	0.85	0.90	0.95	1	1.25
1.50	1.75	2	2.25	2.5	2.75	3	3.5	4
4.5	5	5.5	6	6.5	7	7.5	8	8.5
9	9.5	10	10.5	11	11.5	12	12.5	13
14	15	16	17	17.5	18	19	20	22
24	25	30						

Typical time/current characteristics

Medium (Curves BD, BI, BS, BW)

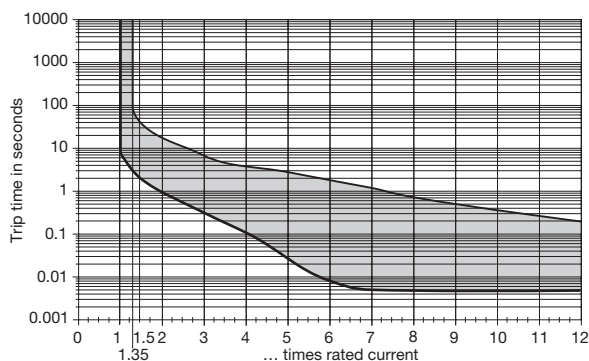

Short (Curves CD, CS, CI and CW)

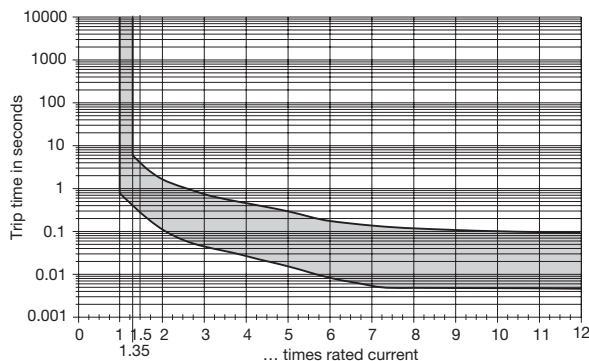

Instantaneous (Curve OP)

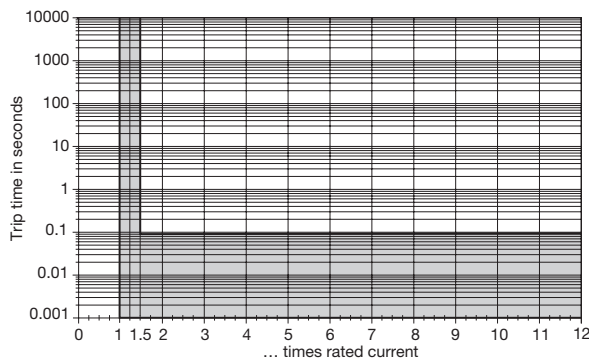

This is a metric design and millimeter dimensions take precedence (mm/ inch).

Typical time/current characteristics

Time Delay Values										
		Percent of rated current								
	Delay	100%	135%	150%	200%	400%	600%	800%	1000%	1200%
Trip	OP	No Trip	May trip	0.100 Max	0.100 Max	0.100 Max	0.100 Max	0.100 Max	0.100 Max	0.100 Max
Time	CS, CD, CI, CW	No Trip	0.300-7.00	0.200-5.00	0.100-2.00	0.030-0.500	0.08-0.300	0.006-0.150	0.005-0.100	0.005-0.100
Seconds	BS, BD, BI, BW	No Trip	3.00-70.0	2.00-40.0	1.00-15.0	0.100-4.00	0.008-2.00	0.006-0.800	0.005-0.350	0.005-0.160

- Delay Curves CS, CD, CI, CW and BS, BD, BI, BW: Breakers to hold 100% and must trip at 135% of rated current and greater within the time limit shown in this curve.
- Delay Curve OP: Breakers to hold 100% and must trip at 150% of rated current and greater within the time limit shown in this curve.
- All Curves: Curve data shown represents breaker response at ambient temperature of 25°C (77°F) with no preloading. Breakers are mounted in standard wall-mount position.
- The minimum inrush pulse tolerance handling capability is 12 times the rated current on standard delays and 18 times the rated current on high inrush delays. These values are based on a 60 Hz 1/2 cycle, 8.33 ms pulse. High inrush delays should be specified for applications with high initial surge currents of short duration, such as switching power supplies, highly capacitive loads and transformer loads.

Internal connection diagrams

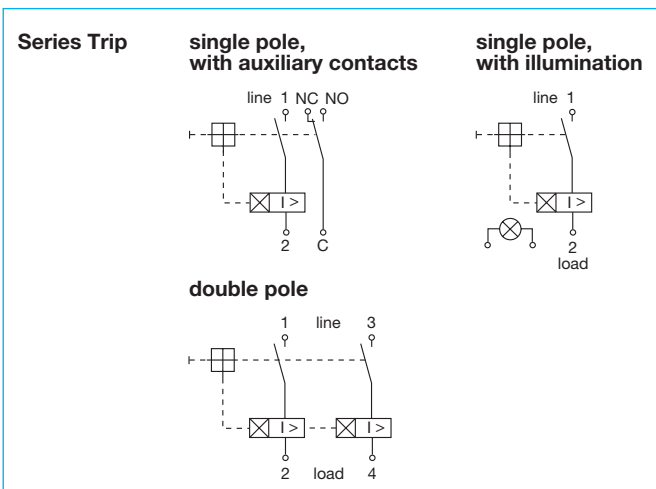

Overview max. current and voltage ratings:

Current rating (A)	Voltage (V)		Number of poles	Approvals		
	DC	AC		TÜV	UL	CSA
0.02-15	32	125	1	yes	yes	yes
15.1-25	32	125	1	-	yes ⁽²⁾	yes ⁽²⁾
0.02-15	65	250	2	0.02-20 A, 0.1-20 A @ 65 V DC	yes ⁽³⁾	yes ⁽³⁾
15.1-25	65	250	2	15.1-20 A	yes ⁽²⁾	yes ⁽²⁾
0.02-12	-	250	1	yes	yes ⁽⁴⁾	yes ⁽⁴⁾
0.02-7,5	50 ⁽¹⁾	-	1	-	yes	yes
0.02-30	65 ⁽¹⁾	-	1	-	yes	yes
0.02-30	80 ⁽¹⁾	-	1	0.1-30 A	yes	yes

The max. voltage depends on the selected frequency (AC, DC) and current rating.
 (1) Special version, upon request
 (2) According to UL category up to 30 A
 (3) 25 A for 65 V DC, 30 A for 250 V AC
 (4) According to UL category up to 18 A

This is a metric design and millimeter dimensions take precedence (mm/inch).

All dimensions without tolerances are for reference only. In the interest of improved design, performance and cost effectiveness the right to make changes in these specifications without notice is reserved. Product markings may not be exactly as the ordering codes. Errors and omissions excepted.

Dimensions – Rocker designs

Two colour rocker style Indicate “ON”

single pole

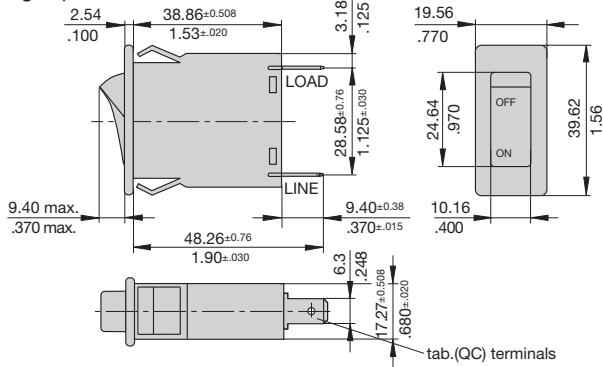

double pole

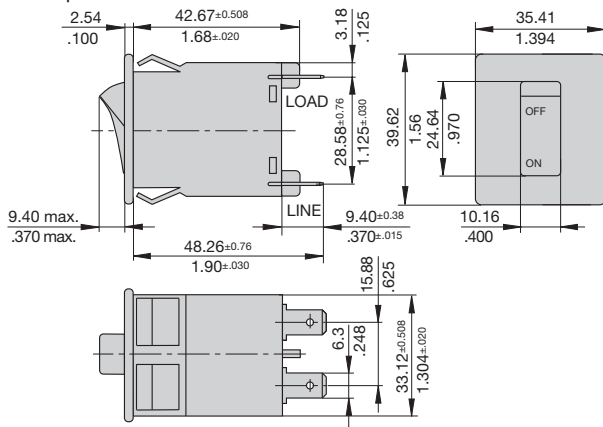

Indicate “OFF”

single pole

double pole

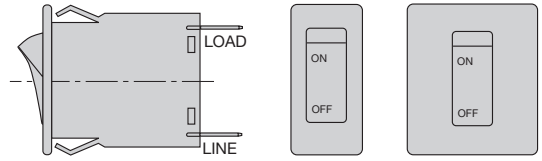

Angled rocker style

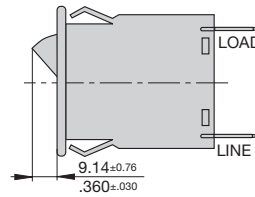

flat rocker style

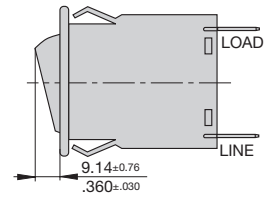

Rocker guard configuration (panel hardware 9)

dimensions also apply to double pole

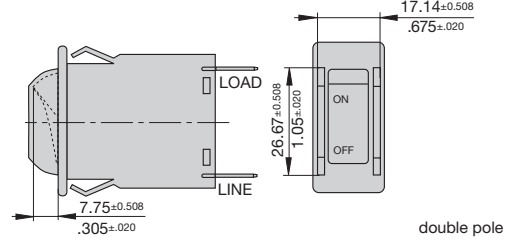

Mounting method (rocker switch versions, flange mounting)

panel thickness [mm / inch]	A [mm / inch]
1.57 / .062	35.18 ^{+0.130 / 1.385^{+0.005}}
2.36 / .093	36.07 ^{+0.130 / 1.42^{+0.005}}
3.18 / .125	37.08 ^{+0.130 / 1.46^{+0.005}}

panel cut-out

single pole

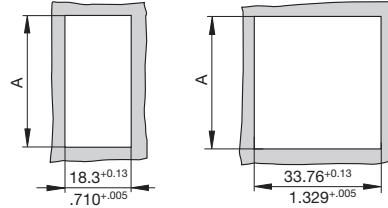

Rocker Actuator Configuration

Legend	Two colour rocker		Single colour rocker	
	Angled		Flat	Angled
	Indicate ON	Indicate OFF		
Vertical	E 	G 	K, T 	R, W
Horizontal	F 	H 	L, U 	S, X

Pictures in the table above show examples for dual legend (I-O ON-OFF).

Please note: When selecting two-colour rocker the rocker's main colour is always selected flange colour. The highlighted part of the rocker (indicated black in drawing above) can be selected individually at „Actuator colour and marking details“

Sample: 8330-FG.0-G...-KX.B 00. .E for a black-white two colour rocker, OFF indication and dual legend vertical imprint

Dimensions – Paddle/Baton designs

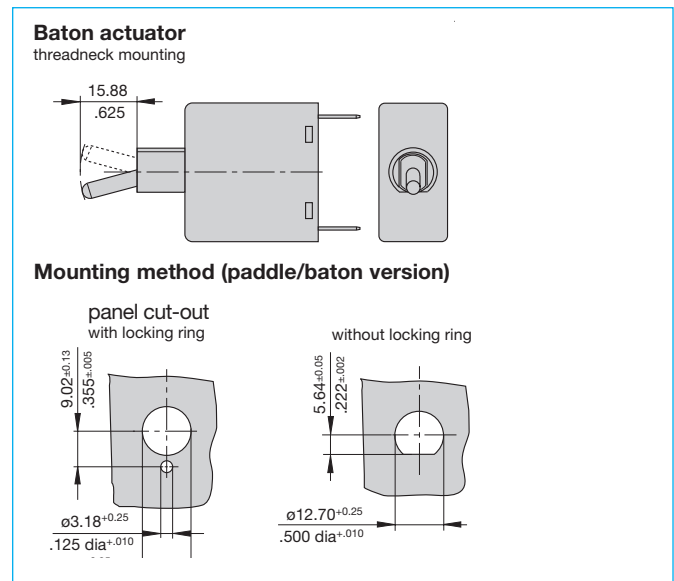
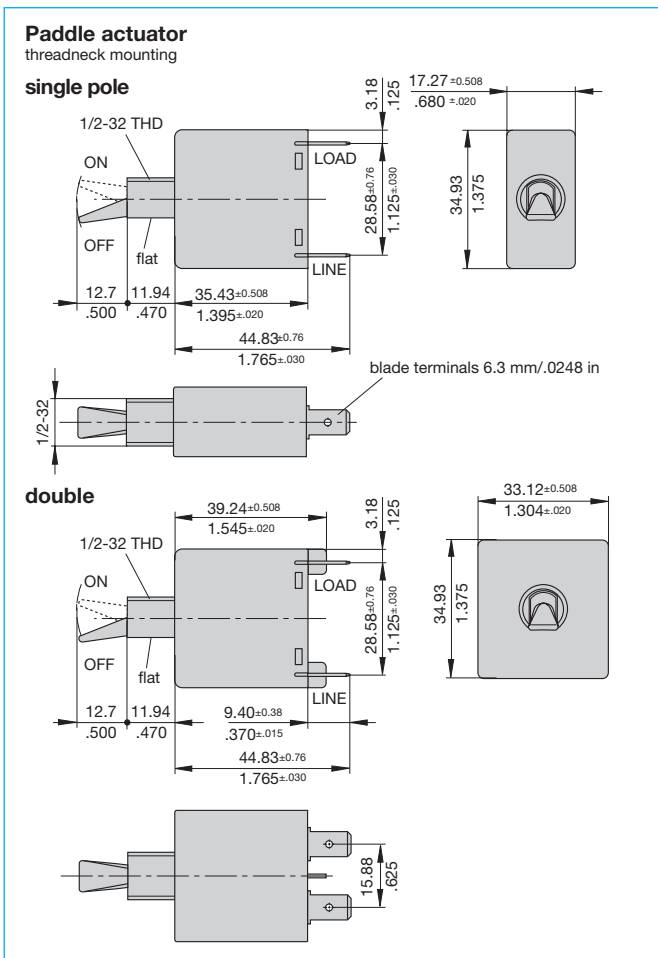

This is a metric design and millimeter dimensions take precedence (mm / inch).

Panel mounting hardware

Paddle/Baton (1/2" designs)

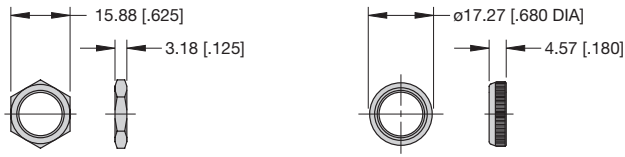

HEX NUT

KNURLED NUT WITH COLLAR

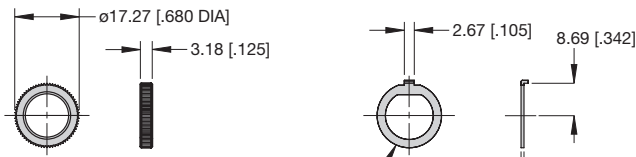

KNURLED NUT

LOCKING RING

Push-Pull and Push-to-Reset (3/8" designs)

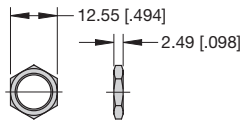

HEX NUT

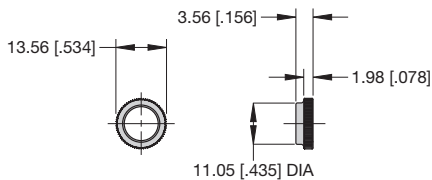

KNURLED NUT WITH COLLAR

Installation drawing

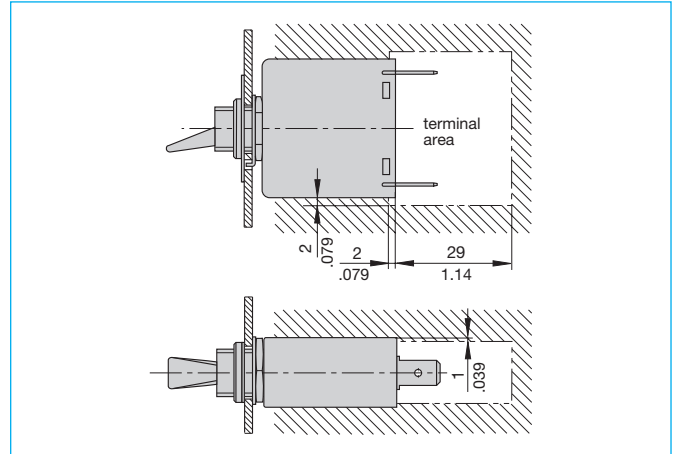

Accessories

Splash cover 1/2" X 221 434 01
(degree of protection IP65)

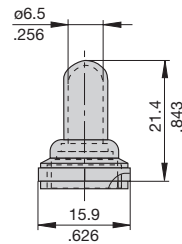

Legend Plates (Paddle/Baton designs)

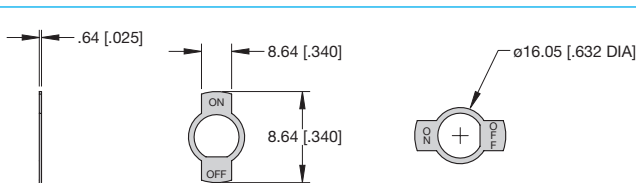

LEGEND CODE:

M, 1

N, 2



LEGEND CODE:

P, 3



Q, 4

This is a metric design and millimeter dimensions take precedence ($\frac{mm}{inch}$).

All dimensions without tolerances are for reference only. In the interest of improved design, performance and cost effectiveness the right to make changes in these specifications without notice is reserved. Product markings may not be exactly as the ordering codes. Errors and omissions excepted.

X-ON Electronics

Largest Supplier of Electrical and Electronic Components

Click to view similar products for [Circuit Breakers](#) category:

Click to view products by [ETA](#) manufacturer:

Other Similar products are found below :

[LUGZX66-1-61-20.0-44](#) [M39019/01-201S](#) [M39019/01-221](#) [M39019/01-323](#) [M39019/01-333](#) [M39019/01-336](#) [M39019/02-248](#) [M39019/02-311](#) [M39019/02-316](#) [M39019/04-249S](#) [M39019/05-246S](#) [M39019/06-254S](#) [M55629/1-016](#) [M55629/1-018](#) [M55629/1-021](#) [M55629/1-033](#) [M55629/1-036](#) [M55629/1-046](#) [M55629/1-048](#) [M55629/1-058](#) [M55629/1-067](#) [M55629/1-070](#) [M55629/1-079](#) [M55629/1-084](#) [M55629/1-085](#) [M55629/1-101](#) [M55629/1-109](#) [M55629/11-102](#) [M55629/1-120](#) [M55629/12-045](#) [M55629/12-046](#) [M55629/1-330](#) [M55629/1-366](#) [M55629/1-387](#) [M55629/1-401](#) [M55629/1-450](#) [M55629/2-022](#) [M55629/2-030](#) [M55629/2-072](#) [M55629/2-082](#) [M55629/2-099](#) [M55629/2-101](#) [M55629/2-102](#) [M55629/21-BM-BM](#) [M55629/21-HM-HM](#) [M55629/21-NS-NS](#) [M55629/22-NR-NR-NR](#) [M55629/22-RS-RS-RS](#) [M55629/2-347](#) [M55629/2-401](#)