



## AOPS600

## 600W Power Supply



### FEATURES

- Wide Input voltage range
- Over voltage protection
- Overcurrent protection
- Built in PFC
- Remote ON/OFF
- Power Fail Signal
- **2 Yr warranty**



MODEL/CHANNEL		Unit	AOPS600-3.3	AOPS600-5	AOPS600-9	AOPS600-12	
OUTPUT	Norminal Voltage	V	3.3	5	9	12	
	Setting Voltage Range	V	3.26~3.33	4.95~5.05	8.91~9.09	11.88~12.12	
	Current	A	100	100	66.5	50	
	Peak Current	A	120	120	66.5	50	
	Line Regulations	mV	25	25	45	60	
	Load Regulations	mV	50	50	90	120	
	Temperature Drift	mV	75	75	135	180	
	Ripple Max.	mV	80	80	120	120	
	Ripple & Noise Max.	mV	120	120	150	150	
	Efficiency	110V	%	69	74	76	78
Typ.	220V		71	77	79	81	
MODEL/CHANNEL		Unit	AOPS600-15	AOPS600-24	AOPS600-28	AOPS600-48	
OUTPUT	Norminal Voltage	V	15	24	28	48	
	Setting Voltage Range	V	14.85~15.15	23.76~24.24	27.72~28.28	47.52~48.48	
	Current	A	40	25	21	12.5	
	Line Regulations	mV	75	120	140	240	
	Load Regulations	mV	150	240	280	480	
	Temperature Drift	mV	225	360	420	720	
	Ripple Max.	mV	120	120	120	150	
	Ripple & Noise Max.	mV	150	150	150	250	
	Efficiency	110V	%	79	81	81	82
	Typ.	220V		83	84	84	85
	Turn-on Time max	ms	1000(ACIN110/220V, Io-100%)				
	Hold-up Time Typ.	ms	20(ACIN110/220V, Io-100%)				





## AOPS600

## 600W Power Supply

MODEL/CHANNEL		Unit	AOPS600-3.3	AOPS600-5	AOPS600-9	AOPS600-12
<b>INPUT</b>	Current	110V	4.3	6.6	7.2	
		220V	2.2	3.3	3.6	
	Power factor	110V	0.98	0.98	0.99	
		Typ. 220V	0.92	0.93	0.95	
MODEL/CHANNEL		Unit	AOPS600-15	AOPS600-24	AOPS600-28	AOPS600-48
<b>INPUT</b>	Current	110V	7.2			
		220V	3.6			
	Power factor	110V	0.99			
		Typ. 220V	0.95			
	Voltage, Frequency	V	AC100-240V(AC85-264V).50/60Hz(47-63)			
	Inrush Current	110V	20 (Ta=25°C, ColdStart)			
Typ. 220V		40 (Ta=25°C, ColdStart)				
Leakage Current	110V	0.5(Typ.)				
	Max. 220V	1(Typ)				
<b>FUNCTION</b>	Over Voltage Protection	V	Works at 115~140% of rating			
	Over Current Protection	A	Works at over 110% of rating and recovers automatically			
	Parallel/Series Operation	-	Possible/ Possible			
	Cooling / O.T.P	-	Forced air by blower fan/Possible			
<b>ELECTRICAL ISOLATION</b>	(1) Input - Output	-	AC 3 KV 1 min, cut-off: 20 mA/DC 500V 100MΩ			
	(2) Input - F.G	-	AC 2 KV 1 min, Cut-off: 20 mA/DC 500V 100MΩ			
	(3) Output - F.G	-	AC 0.5 KV 1 min, Cut-off: 100mA/DC 500V 100 MΩ			
<b>Environment</b>	Operating temp. & Humidity	-	-10~65°C 20~90% RH (Non Condensing)			
	Storage temp. & Humidity	-	-20~75°C 20~90% RH (Non Condensing)			
	Vibration	-	10~55 Hz at 2G 3 minutes period, 30 minutes along X. Y and Z axis			
	Safety	-	Complied with EN60950-1			
	Conducted Emission	-	Complied with EN55022-B			
	PFHC	-	Complied with IEC61000-3-2			
<b>Dimension</b>	Size(LxWxH)/Weight	mm/g	190x92x120/2000			





## Block Diagram

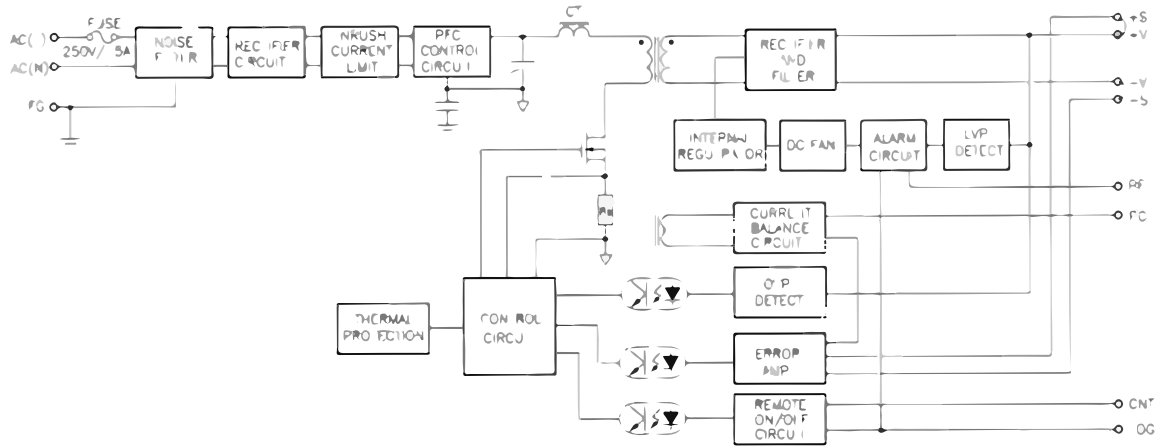

## Derating Curve

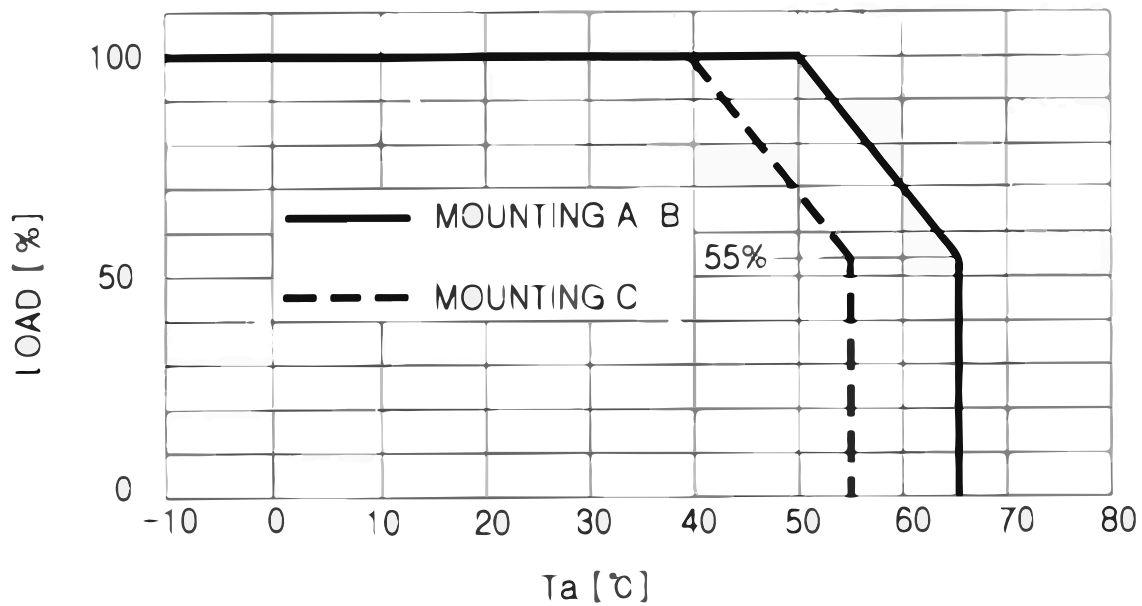



## Mounting/Installation

( A ) Standard Mounting

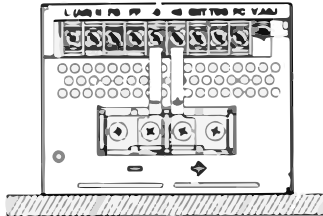

( B )

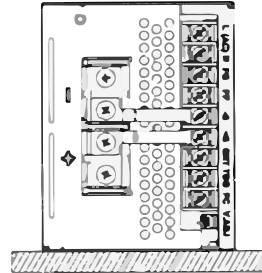

( C )

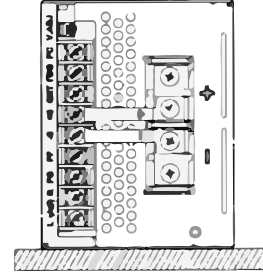

( D ) Inhibit

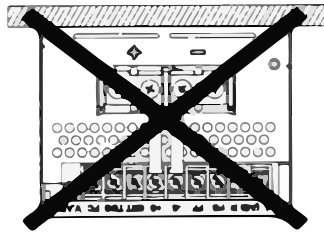

( E ) Inhibit

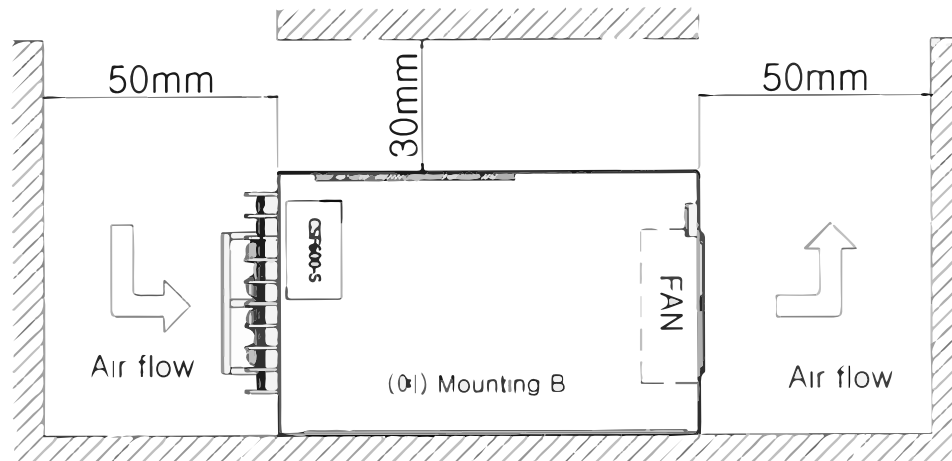
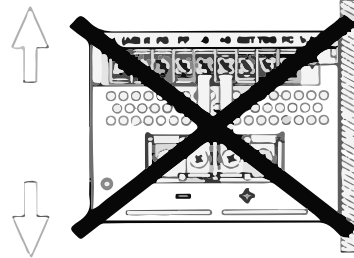



## Terminal Connection

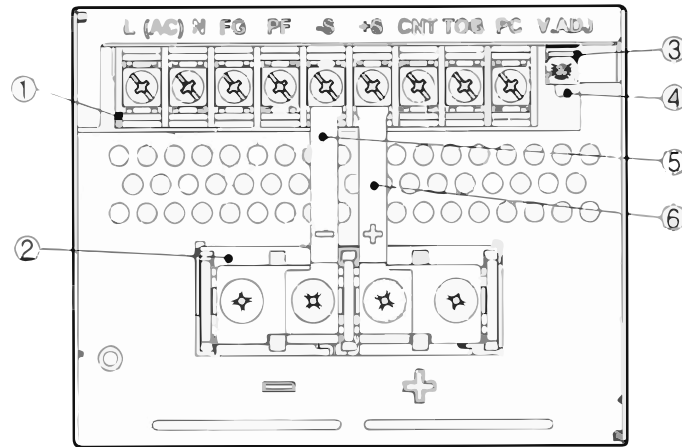

① TB1 Terminal Block (Screw M3 5X8)

Mark	Pin Connection	Function
L	AC Live line	AC Terminal (Fuse in line)
N	AC Neutral line	AC Terminal
FG	Frame ground	AC CASE
PF	Power fail signal	Power fail signal Terminal
-S	(-) Remote sensing	DC (-) Remote sensing terminal
+S	(+) Remote sensing	DC (+) Remote sensing terminal
CNT	Remote ON/OFF (+)	Remote ON/OFF (+) control terminal
TOG	CNT PF ground	CNT PF signal ground terminal
PC	Current balance	SMPS Current balance terminal





## Mechanical Drawings

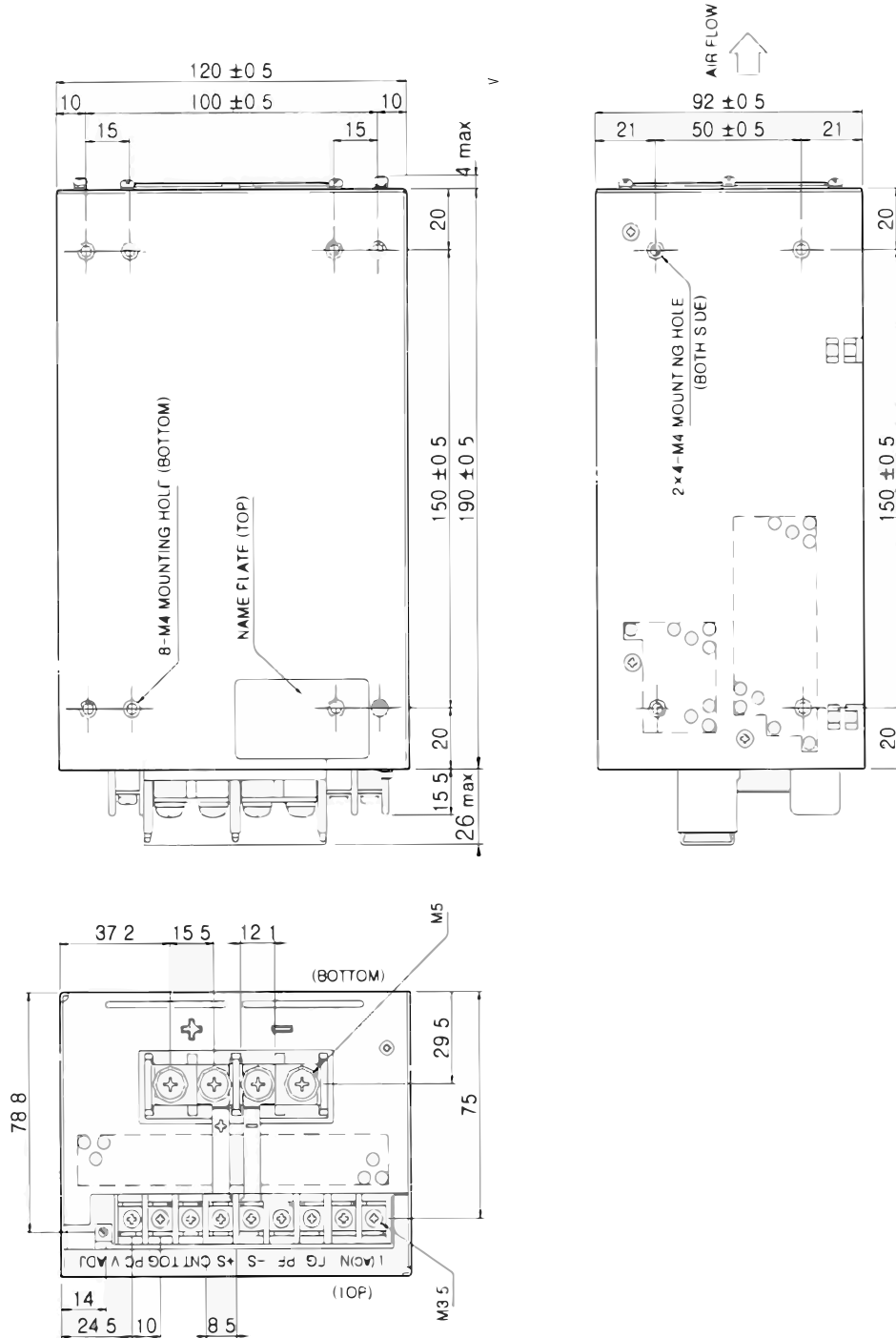

## X-ON Electronics

Largest Supplier of Electrical and Electronic Components

*Click to view similar products for [Switching Power Supplies](#) category:*

*Click to view products by [ETA](#) manufacturer:*

Other Similar products are found below :

[70841011](#) [73-551-0005](#) [73-551-0048](#) [PS3E-B12F](#) [PS3E-E12F](#) [AAD600S-4-OP](#) [R22095](#) [KD0204](#) [9021](#) [LDIN100150](#) [LPM000-BBAR-01](#)  
[LPX17S-C](#) [EVS57-10R6/R](#) [FP80](#) [FRV7000G](#) [22929](#) [PS3E-F12F](#) [CQM1IA121](#) [40370121900](#) [VI-PU22-EXX](#) [40370121910](#) [LDIN5075](#)  
[LPM615-CHAS](#) [LPX140-C](#) [09-160CFG](#) [70841025](#) [VPX3000-CBL-DC](#) [LPM000-BBAR-05](#) [LPM000-BBAR-08](#) [LPM124-OUTA1-48](#)  
[LPM000-BBAR-07](#) [LPM109-OUTA1-10](#) [LPM616-CHAS](#) [08-30466-1055G](#) [08-30466-2175G](#) [08-30466-2125G](#) [DMB-EWG](#) [TVQF-1219-](#)  
[18S](#) [6504-226-2101](#) [CQM1IPS01](#) [SP-300-5](#) [CQM1-IPS02](#) [VI-MUL-ES](#) [22829](#) [08-30466-0065G](#) [VI-RU031-EWWX](#) [08-30466-0028G](#) [VI-](#)  
[LUL-EU](#) [EP3000AC48INZ](#) [VP-C2104853](#)