

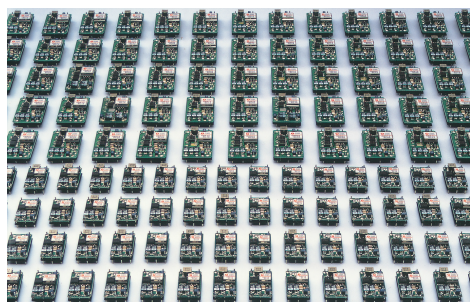

OBQ-SC/WC

3W Open Frame



FEATURES

- PCB Mountable
- Small, Light Weight
- High Efficiency
- Cost effective
- Output Voltage adjustable
- Over Voltage Protection
- **Isolated Power Supply**



MODEL/CHANNEL		Unit	OBQ05SC	OBQ12SC	OBQ15SC	OBQ24SC	OBQ22SC	OBQ23SC						
OUTPUT	Output Voltage	Vdc	5	12	15	24	±12	±15						
	Output Current	A	0.5	0.25	0.2	0.13	0.13	0.1						
	Line Regulation max.	mV	25	60	75	120	60	75						
	Load Regulation max.	mV	25	60	75	120	±1000	±1000						
	Dynamic Line	mV	250	200	200	200	200	200						
	Dynamic Load	mV	150	360	450	720	360	450						
	Voltage Tolerance	mV	100	240	300	480	240	300						
	Drift	mV	40	75	90	135	75	90						
	Ripple and Noise(max.)	mVp	100											
	Temperature Coefficient	-	0.03%/°C(maximum)											
Recovery Time	mS	20mS(typical)												
Rise Up Time	mS	10mS(typical) at rated input/output												
MODEL/CHANNEL		Unit	OBQ05 SC0512	OBQ12 SC0512	OBQ15 SC0512	OBQ24 SC0512	OBQ22 WC0512	OBQ23 WC0512						
INPUT	Input Voltage	Vac	5	12	5	12	5	12	5	12	5	12	5	12
	No Load	mA	41	44	51	54	51	53	57	59	66	64	64	64
	Full Load	mA	676	297	789	342	779	337	800	346	843	356	800	342
	Line Back Noise	mVp	200	100	100	80	200	100	200	100	200	100	200	100
	Efficiency (typical)	%	74	70	76	73	77	74	78	75	74	73	75	73
	Input Voltage Range	Vdc	4.5-16V											





MODEL/CHANNEL		Unit	OBQ05 SC1224		OBQ12 SC1224		OBQ15 SC1224		OBQ24 SC1224		OBQ22 WC1224		OBQ23 WC1224	
INPUT	Input Voltage	Vdc	12	24	12	24	12	24	12	24	12	24	12	24
	Input Range No Load	mA	22	24	28	29	28	29	30	30	35	31	32	29
	Input Range Full Load	mA	267	144	312	168	304	164	317	171	329	173	308	164
	Line Back Noise	mVp	300	150	300	150	300	150	300	150	1000	500	1000	500
	Efficiency (typical)	%	78	72	80	74	82	76	82	76	79	75	81	76
	Input Voltage Range	Vdc	8-32											
MODEL/CHANNEL		Unit	OBQ05 SC2448		OBQ12 SC2448		OBQ15 SC2448		OBQ24 SC2448		OBQ22 WC2448		OBQ23 WC2448	
INPUT	Input Voltage	Vdc	24	48	24	48	24	48	24	48	24	48	24	48
	Input Range No Load	mA	10	11	15	15	15	15	15	15	14	14	14	14
	Input Range Full Load	mA	136	72	154	82	152	81	158	84.4	160	86	152	75
	Line Back Noise	mVp	100	80	100	80	100	80	100	80	200	100	200	100
	Efficiency (typical)	%	76	72	81	76	82	77	82	77	81	76	82	76
	Input Voltage Range	Vdc	18-72V											
Environment	Operating Temperature	°C	-20 to +71°C											
	(derating)	°C	3.5%/°C (50°C to 71°C) (out of warranty >=71°C)											
	Operating Humidity	%	20-90%/RH(non-condensing)											
	Storage Temperature	°C	-20 to +85°C											
	Storage Humidity	%	20 to 90%/RH(non-condensing)											
	Withstanding Voltage	-	Primary-Secondary AC500V for 1minute											
	Isolation Voltage	-	Primary-Frame Ground 50MΩ(minimum) by DC500V insulation tester											
	Shock	-	294m/s ²											
	Cooling	-	Convection											
	Vibration	-	5-10Hz: 10mm double amplitude, 10-55Hz: 19.6m/s ² , 20 minutes period for 60 minutes each along X,Y,Z axes(non-operating)											
Function	Trimming of Output	-	+250	+250	+350	+650								
		-	-250	-900	-1600	-4000								
	Overcurrent Protection	-	Foldback/Current Limiting with automatic recovery at discontinuous short circuit conditions											
	Input Fuse	-	Installed											
Capacitance	pF	2200												
Dimension	Size(WxHxD) / Weight	mm/g	20.1Wx32Lx10.4H open board type/6g											





Derating Diagram

3W Open Frame

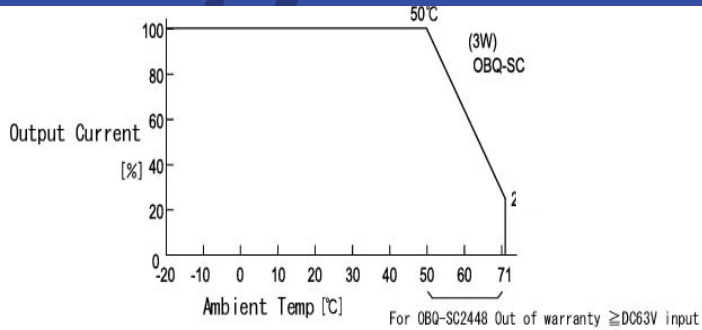

Dimension Diagram (mm)

3W Open Frame

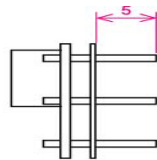
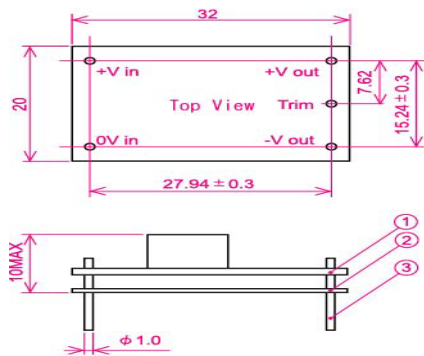

- ① Double-sided PCB FR4t=1.0
 - ② t=0.5 Insulator V0
 - ③ 1.0DIA PIN Material:BsB 2700 1/2H
Copper Plating 1~3 μ m
Solder Plating 3~6 μ m
- * Tolerance ± 0.5

Block Diagram (mm)

3W Open Frame

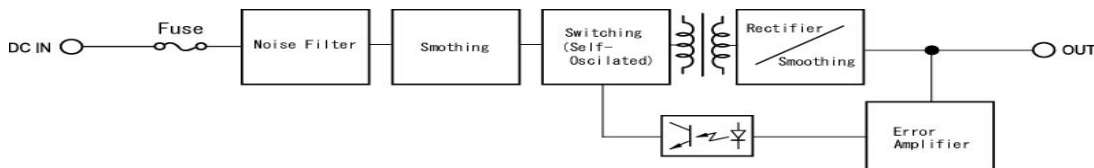



OCP Curves

3W Open Frame

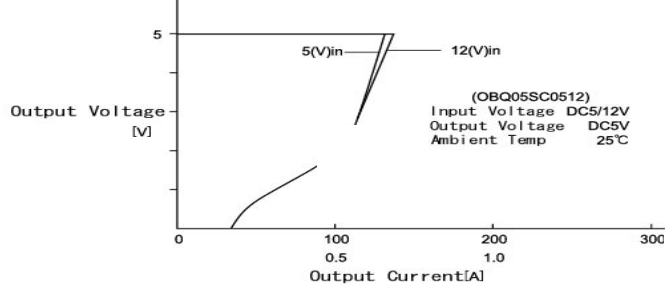

Efficiency Curve

3W Open Frame

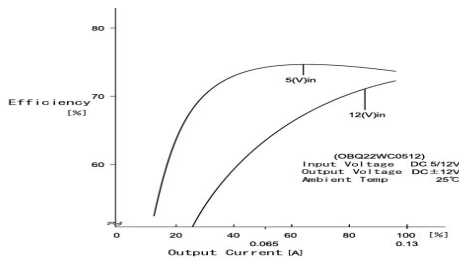

■ OBQ-SC/WC

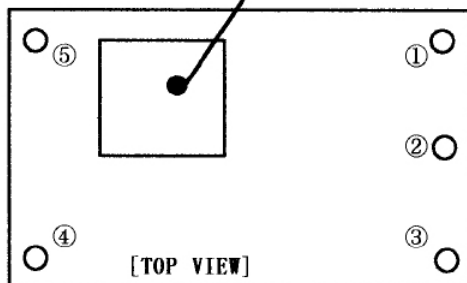

- ① : + [V]
- ② : COM
- ③ : 0 [V]
- ④ : DC - 0 [V]
- ⑤ : DC + [V]



X-ON Electronics

Largest Supplier of Electrical and Electronic Components

Click to view similar products for [Isolated DC/DC Converters](#) category:

Click to view products by [ETA](#) manufacturer:

Other Similar products are found below :

[ESM6D044440C05AAQ](#) [FMD15.24G](#) [PSL486-7LR](#) [Q48T30020-NBB0](#) [JAHW100Y1](#) [SPB05C-12](#) [SQ24S15033-PS0S](#) [19-130041](#) [CE-1003](#)
[CE-1004](#) [GQ2541-7R](#) [RDS180245](#) [MAU228](#) [J80-0041NL](#) [DFC15U48D15](#) [XGS-0512](#) [XGS-1205](#) [XGS-1212](#) [XGS-2412](#) [XGS-2415](#) [XKS-](#)
[1215](#) [06322](#) [NCT1000N040R050B](#) [SPB05B-15](#) [SPB05C-15](#) [L-DA20](#) [DCG40-5G](#) [QME48T40033-PGB0](#) [XKS-2415](#) [XKS-2412](#) [XKS-2405](#)
[XKS-1212](#) [XKS-1205](#) [XKS-0515](#) [XKS-0505](#) [XGS-2405](#) [XGS-1215](#) [XGS-0515](#) [PS9Z-6RM4](#) [73-551-5038I](#) [AK1601-9RT](#) [VI-R5022-](#)
[EXWW](#) [PSC128-7iR](#) [RPS8-350ATX-XE](#) [DAS1004812](#) [VI-LJ11-iz](#) [PQA30-D24-S24-DH](#) [VI-M5F-CQ](#) [VI-LN2-EW](#) [VI-PJW01-CZY](#)