



ODM20-SC

20W DC/DC



Features

- Single Output
- Efficiency 86%~ 90%
- Wide operating temperature from -40°C to +85°C
- No minimum load required
- Medical safety, Meets 2xMOPP per 3rd EN60601-1
- Available Inputs Voltage (nominal)
- EMI class A without external circuit
- Test with E-CAP 220 μ F/100V at input terminal
- 12VDC Nom (DC 9~18V)
- 24VDC Nom (DC 18 ~ 36V)
- 48VDC Nom (DC 36 ~ 75V)
- 2:1 Wide input range VDC; UL94V-0 package material
- 2 Years Warranty



MODEL/CHANNEL		Unit	ODM20-05SC12	ODM20-12SC12	ODM20-15SC12	ODM20-24SC12
OUTPUT	Nominal Voltage	V	5	12	15	24
	Current	A	4	1.67	1.333	84
	Ripple & Noise(pk-pk)	mVp-p	60	60	60	120
	Capacitive Load	mV	6800	1200	800	300
	Efficiency	%	86	89	88	89
MODEL/CHANNEL		Unit	ODM20-05SC24	ODM20-12SC24	ODM20-15SC24	ODM20-24SC24
OUTPUT	Nominal Voltage	V	5	12	15	24
	Current	A	4	1.67	1.333	84
	Ripple & Noise(pk-pk)	mVp-p	60	60	60	120
	Capacitive Load	mV	6800	1200	800	300
	Efficiency	%	87	89	88	90
MODEL/CHANNEL		Unit	ODM20-05SC48	ODM20-12SC48	ODM20-15SC48	ODM20-24SC48
OUTPUT	Nominal Voltage	V	5	12	15	24
	Current	A	4	1.67	1.333	84
	Ripple & Noise(pk-pk)	mVp-p	60	60	60	120
	Capacitive Load	mV	6800	1200	800	300
	Efficiency	%	87	89	88	90
	Operating Frequency	kHz	300			
	Line Regulations	mV	+/-0.5			
	Load Regulations	mV	+/-0.5			
	Total Power	W	20			
	Voltage Accuracy	%	+/-1			
	Leakage Current	μ A	5			
	Transient Res. Recovery Time	μ s	500			





ODM20

20W DC/DC

MODEL/CHANNEL		Unit	ODM20-SC12	ODM20-SC24	ODM20-SC48
INPUT	Voltage, Frequency	V	(9~18) 10	(18~36) 7	(36~75) 5
	Start Up Time	mS	Nom. Vin at 100% load Typ. 25ms		
	Voltage Lockout 12 VDC 24VDC 48VDC	VDC	Typ. 7.5VDC Typ. 15VDC Typ. 33VDC		
	Voltage Surge 12 VDC 24VDC 48VDC	VDC	Max. 25VDC Max. 50VDC Max. 100VDC		
Function	Isolation Voltage	Vac	Min. 5000VAC rms		
	Isolation Capacitance	pf	100KHZ, 1V Typ. 100pF		
	Isolation Resistance	-	Min. 10GΩ		
	Overload Protection	-	HICCUP MODE Typ. 150%		
Environment	Cooling Method	-	Convection		
	Operating temp. & Humidity	-	-40 ~ +100°C		
	Storage temp. & Humidity	-	-55 ~ +105°C		
	MTBF	-	25°C MIN. 1016 KHrs		
	Safety/Emission	-	EN61000-4-2, Air±15Kv; Contact±8kV Perf. Criteria A EN61000-4-3, 10V/m Criteria A EN61000-4-4, ±2kV Criteria A	EN61000-4-5, ±1kV Criteria A EN55011 Class A EN61000-4-6, 10Vr.m.s Criteria A	
Dimension	Size(LxWxH) /Weight	mm/g	50.8x25.4x12/30		
	Case Material Potting Material	-	PLASTIC MATERIAL		





- EMI class A without external circuit
- Test with E-CAP 220 μ F/100V at input terminal

Derating Curve

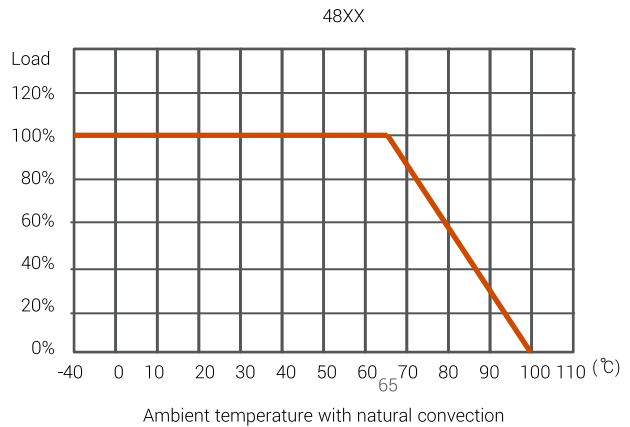
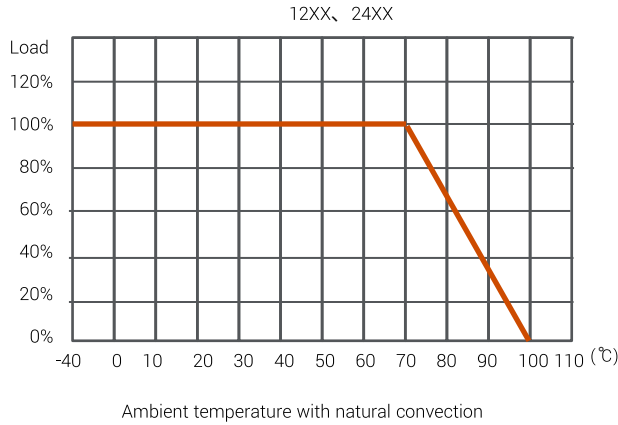

Filtering

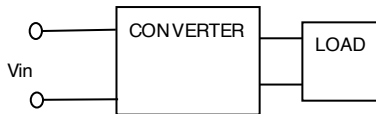

*The external filter for EN55022 Class A.

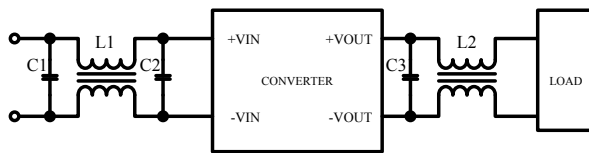

Class B

C1	MLCC X7R 10UF
C2	MLCC X7R 10UF
C3	MLCC X7R 4.7UF
L1	Mn-Zn μ i=7000 C.M. choke (separated) 2mH
L2	Ni-Zn μ i=500 C.M. choke (parallel) 30uH

Design Diagram

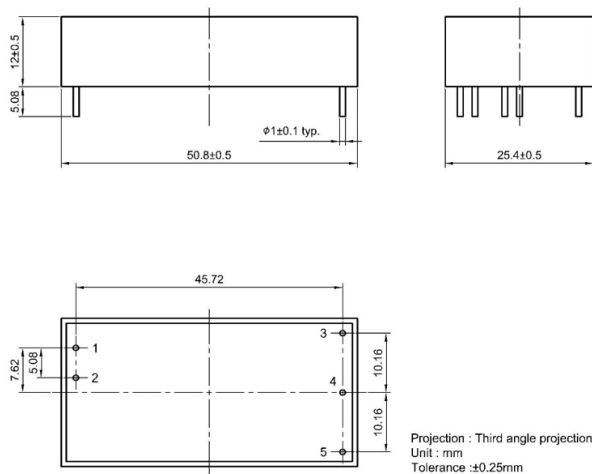

Pin	Function
1	+Vin
2	-Vin
3	+Vout
4	No Pin
5	-Vout





Ripple and Noise

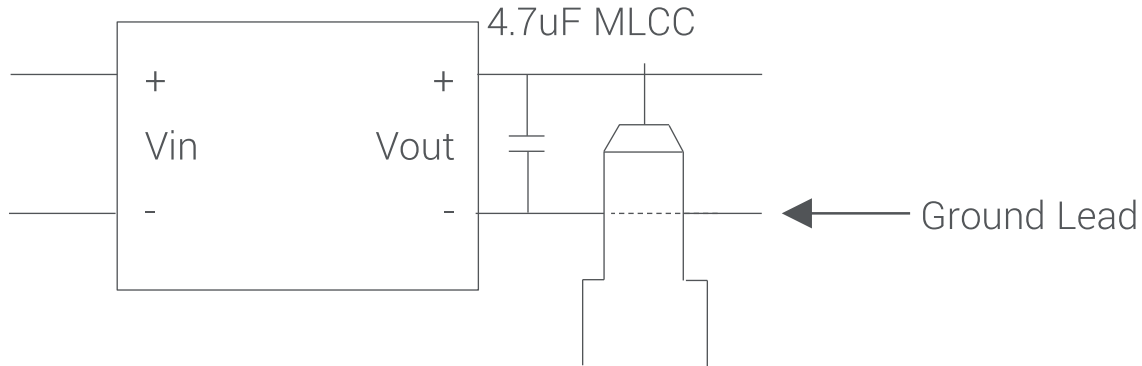

Packaging

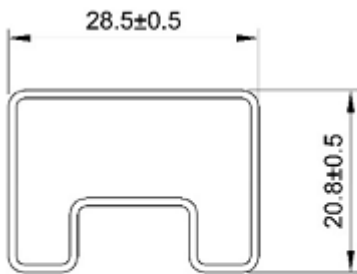

UNIT:mm
1 Tube = 8 pcs
Length:260±2mm

PACKAGING Parts packaged in tubes of (8)



X-ON Electronics

Largest Supplier of Electrical and Electronic Components

Click to view similar products for [Isolated DC/DC Converters](#) category:

Click to view products by [ETA](#) manufacturer:

Other Similar products are found below :

[ESM6D044440C05AAQ](#) [FMD15.24G](#) [PSL486-7LR](#) [Q48T30020-NBB0](#) [JAHW100Y1](#) [SPB05C-12](#) [SQ24S15033-PS0S](#) [19-130041](#) [CE-1003](#)
[CE-1004](#) [GQ2541-7R](#) [RDS180245](#) [MAU228](#) [J80-0041NL](#) [DFC15U48D15](#) [XGS-0512](#) [XGS-1205](#) [XGS-1212](#) [XGS-2412](#) [XGS-2415](#) [XKS-](#)
[1215](#) [06322](#) [NCT1000N040R050B](#) [SPB05B-15](#) [SPB05C-15](#) [L-DA20](#) [DCG40-5G](#) [QME48T40033-PGB0](#) [XKS-2415](#) [XKS-2412](#) [XKS-2405](#)
[XKS-1212](#) [XKS-1205](#) [XKS-0515](#) [XKS-0505](#) [XGS-2405](#) [XGS-1215](#) [XGS-0515](#) [PS9Z-6RM4](#) [73-551-5038I](#) [AK1601-9RT](#) [VI-R5022-](#)
[EXWW](#) [PSC128-7iR](#) [RPS8-350ATX-XE](#) [DAS1004812](#) [VI-LJ11-iz](#) [PQA30-D24-S24-DH](#) [VI-M5F-CQ](#) [VI-LN2-EW](#) [VI-PJW01-CZY](#)