

Description

Switched mode power supply for rail mounting, wide range voltage input, high efficiency, integral active power factor compensation (PFC), parallel mode for performance improvement

Features and Benefits

- Wide range voltage input from AC 88 to 264 V
- Efficiency up to 93%
- Integral power factor compensation
- Parallel mode for performance improvement (selectable by switch)

Typical applications

Process control, industrial switch- and controlgear, machine construction, telecommunication systems

Order numbering code

Type No.

SMP11 Single phase switch-mode power supply for rail mounting

Connector design

L pcb mounting (preferred type)

S plug-in type

Terminal design

20 screw terminals

Output voltage

DC24V DC 24 V

Output current

10 A

SMP11-L20-DC24V-10A ordering example

Approvals

Approval authority	Standards
UL	UL508, CSA C22.2 No. 107.1 (listed) UL 60950-1, CSAC22.2 No. 60950-1 (recognized)
TÜV Rheinland	EN 60950-1

EMC

EN 61000-6-3, EN 61000-6-2, EN 61204-3



SMP11-DC24V/10A
Version L20

Technical data ($T_U = 25^\circ\text{C}$, $U_B = \text{AC } 100 \text{ V} \dots 240 \text{ V}$, $I_0 = 10 \text{ A}$)

Operating data

Input voltage ranges U_E	AC 88...264 V
Operating voltage range U_B	AC 100...240 V
Effective output	240 W
Output voltage U_O	24 V SELV
Output current rating I_O	10 A
Efficiency	91 % min. / 93 % typically

General data

Switching frequency	typically 90 kHz
Insulation voltage between input and output	AC 3000 V, DC 4242 V
input and protective conductor	AC 1500 V, DC 2121 V
output and protective conductor	AC 500 V, DC 710 V
Insulation resistance	100 M Ω (DC 500 V) between input and output
Ambient temperature	-40°C...+71°C
Derating factor (see curve)	2.5 % / °C
Storage temperature	-40°C...+85°C
Relative humidity	20...90 % RH
MTBF to Bellcore, ed. 6	481,000 hours at 40°C, GB
Max. altitude in operation to IEC 60068-2-13	5000 m above sea level
Cooling	by convection
Mounting direction	wall-mounted (see dimensions)
Pollution degree	2

Input circuit

Input rated voltage	AC 100...240 V
Input voltage range	AC 88...264 V
Input current	1.15 A typically at $U_B = \text{AC } 230 \text{ V}$ 2.3 A typically at $U_B = \text{AC } 115 \text{ V}$
Max. input current	3.2 A typically at $U_B = \text{AC } 88 \text{ V}$
Supply frequency	47...63 Hz
Inrush current at AC 115 V	24 A max.
at AC 230 V	48 A max.

Technical data ($T_U = 25^\circ\text{C}$, $U_B = \text{AC } 100 \text{ V} \dots 240 \text{ V}$, $I_0 = 10 \text{ A}$)

Power loss (at U_B 230 V, I_0 10 A)	18 W typically
Power factor compensation (active)	typically 0.97
Output circuit	
Rated voltage U_0	DC 24 V SELV
Current rating I_0	10 A
Output voltage accuracy	0...+1 %
Min. load	0 %
Supply regulation	$\pm 1\%$ at U_E min. ... U_E max.
Load regulation	
Single mode	$\pm 1\%$
Parallel mode	$\pm 5\%$
Voltage adjustment range	DC 22.5 ... 28.5 V at $0.8 \times I_0$
Continuous load	10 A at $U_0 = \text{DC } 24 \text{ V}$, 8.4 A at $U_0 = \text{DC } 28.5 \text{ V}$
Power boost factor	typically 120 % / typically 150 % - 3s, see output trip curve
Short circuit behaviour	Hiccup mode
Exposure time	25 / 20 ms
ON delay at:	
resistive load	1 s
capacitive load of 7,000 μF	1.5 s
Rise time at:	
resistive load	150 ms
capacitive load of 7,000 μF	0.5 s
Release time	150 ms
Residual ripple	100 mV, spectrum = 20 MHz
Power back immunity	DC 35 V min.
Capacitive load	7,000 μF max.
Parallel mode	3 power supplies max. at $0.1 \times I_0 \dots$ $0.9 \times I_0$

Technical data ($T_U = 25^\circ\text{C}$, $U_B = \text{AC } 100 \text{ V} \dots 240 \text{ V}$, $I_0 = 10 \text{ A}$)

Control and protection circuit	
Input protection	internal blade fuse T5A / AC 250 V
Recommended back-up fuse	1-pole MCB, e.g. E-T-A type 4230
Current rating	10 A / 16 A \rightarrow max. 20 A
Characteristic curve	B / C / D
Internal overvoltage protection	varistor
Aux. contact (output RDY)	Contact closed at: DC 17.6...19.4 V
Insulation voltage	DC 500 V (to output)
Contact load at	DC 60 V / 0.3 A
Overvoltage protection	30...33 V at $0.8 \times I_0$
Degree of protection	IP20
Physical data	
Dimensions (h x w x d)	
version L20 with screw terminals:	124.5 x 64 x 123.6 mm (4.9 x 2.52 x 4.87 inches)
version S20 with removeable plug	143.5 x 64 x 123.6 mm (5.65 x 2.52 x 4.87 inches)
Housing material:	metal
Mass	approx. 860 g
Vibration (random vibration to IEC 60068-2-6)	mounted on symmetrical rail, 10 - 500 Hz, 2 g, on X, Y & Z axis, per axis 10 min. / 60 min.
Shock (random to IEC 60068-2-27)	halfsine 4 g (22 ms), 3 axes, 6 sides, 3 times per side

Dimensions

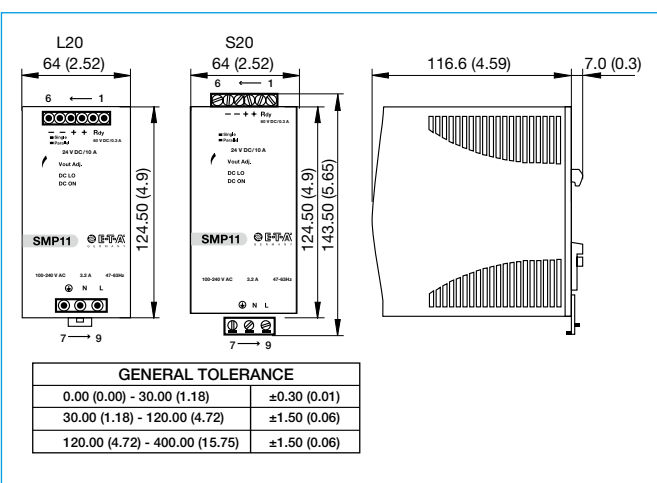

3

Mounting and Installation

Mounting	snap onto DIN rail (TS35/7.5 or TS35/15)
Ventilation / cooling	normal air convection, recommended distance on each side 25 mm
Mounting position	wall-mounted with the input terminals pointing downwards (see dimensions)

Version L20 with screw terminals:

Screw terminals	input terminal AWG24-10 (0.2 mm ² – 4 mm ²) flexible/rigid output terminal AWG24-10 (0.2 mm ² – 4 mm ²) flexible/rigid
Tightening torque	input connector 1 Nm max. Output terminal 0.6 Nm max.
Wire stripping length	8 mm

Version S20 with removeable plug

Screw terminals	input terminal AWG24-10 (0.2 mm ² – 4 mm ²) flexible/rigid output terminal AWG24-10 (0.2 mm ² – 4 mm ²) flexible/rigid
Tightening torque	input connector 0.5 Nm max. Output connector 0.8 Nm max.
Wire stripping length	4...5 mm

Pin assignment - Display - Controls

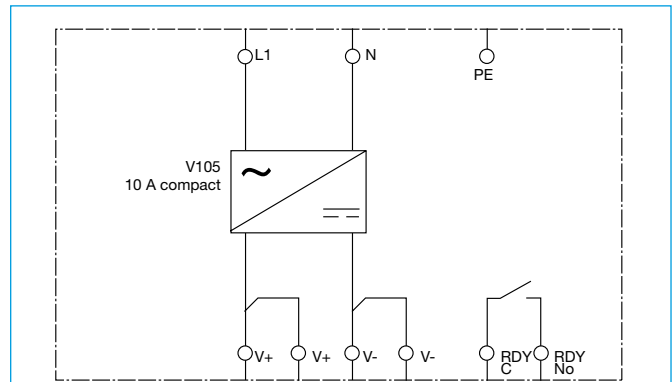

pin no.	name	description
1	RDY	limit value DC ON, relay contact (make contact)
2		
3,4	V +	Output voltage +
5,6	V -	output voltage -
7	PE	earth conductor
8	N	Input voltage, neutral conductor (not polarised with DC input voltage)
9	L	Input voltage, phase conductor (not polarised with DC input voltage)
	DC ON	visual status indication with LED
	DC LO	DC LOW output voltage LED indication
	Vout Adj	potentiometer for adjustment of output voltage U _o
	S/P	change-over switch single / parallel mode

3

Schematic diagram

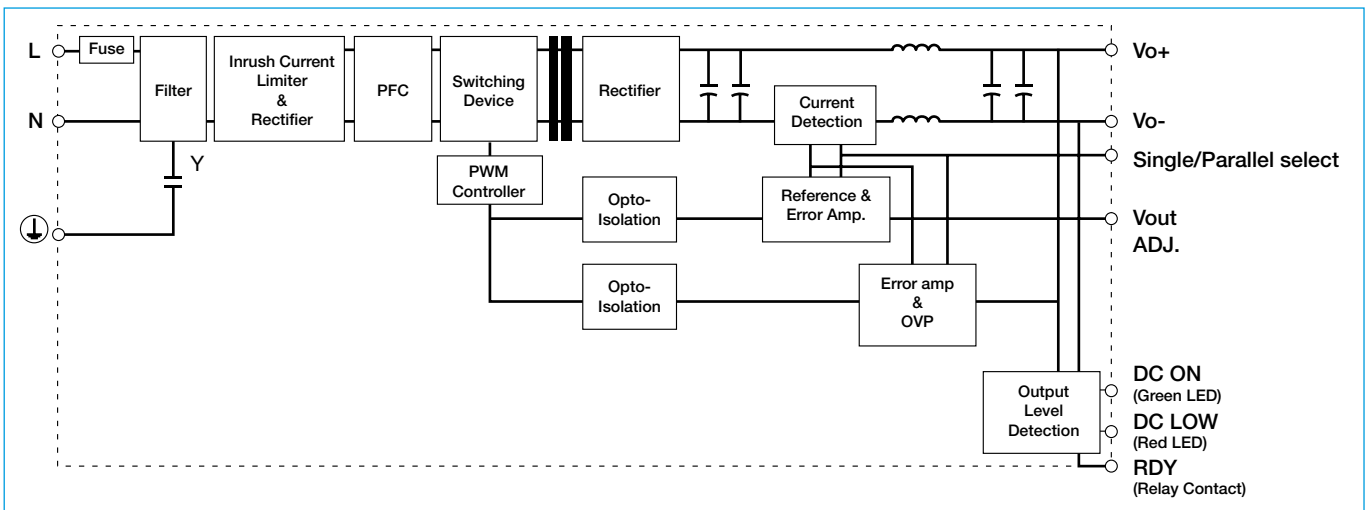

Typical output trip curve

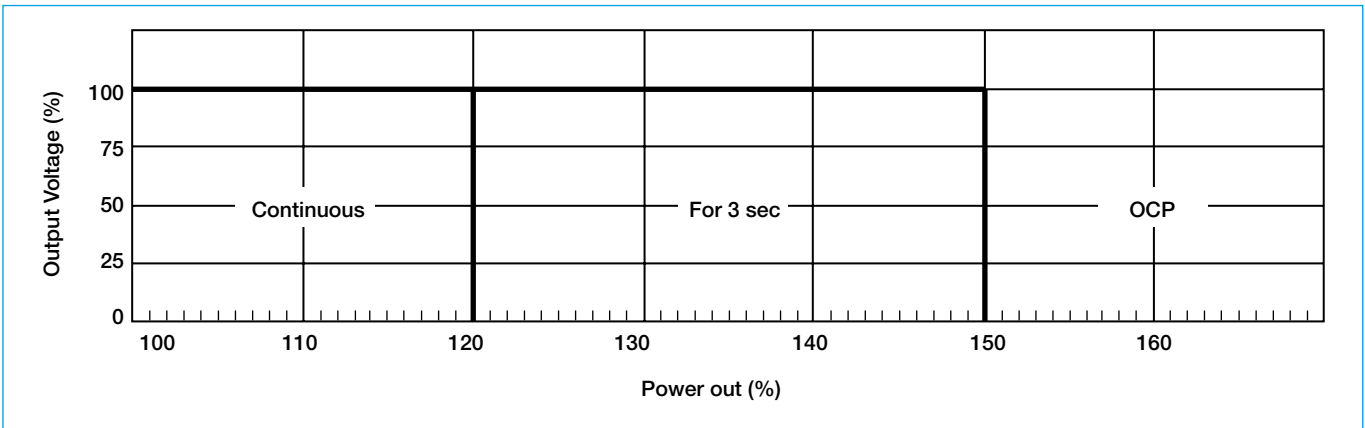

Derating curve

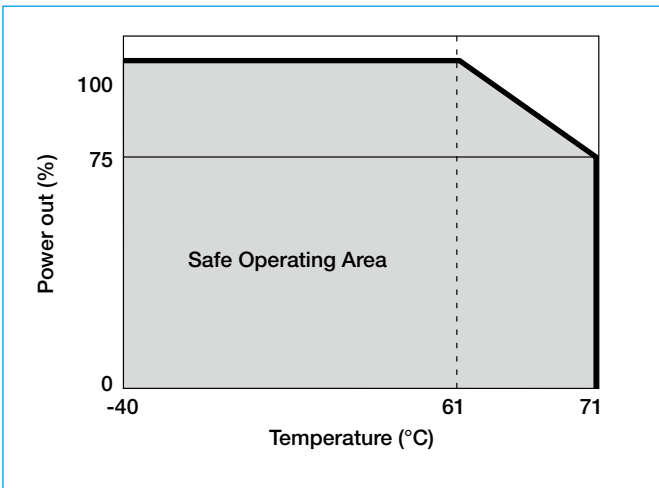

Typical efficiency curve

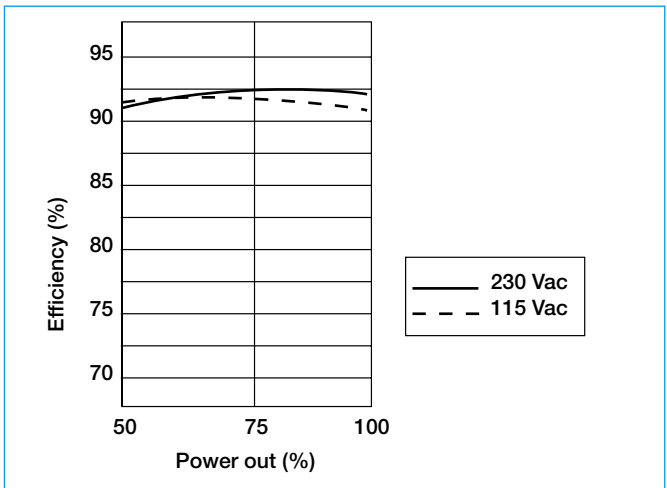

Current-voltage curve

current-voltage-curve → short circuit

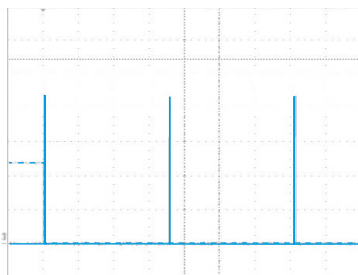

current: — 10 A / Div
voltage: - - - 10 V / Div
time 1 s / Div.

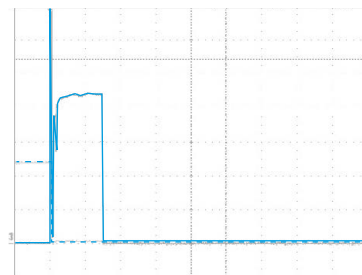

current: — 10 A / Div
voltage: - - - 10 V / Div
time 20 ms / Div.

3

Application example with protection by 4230-T and REF16-S

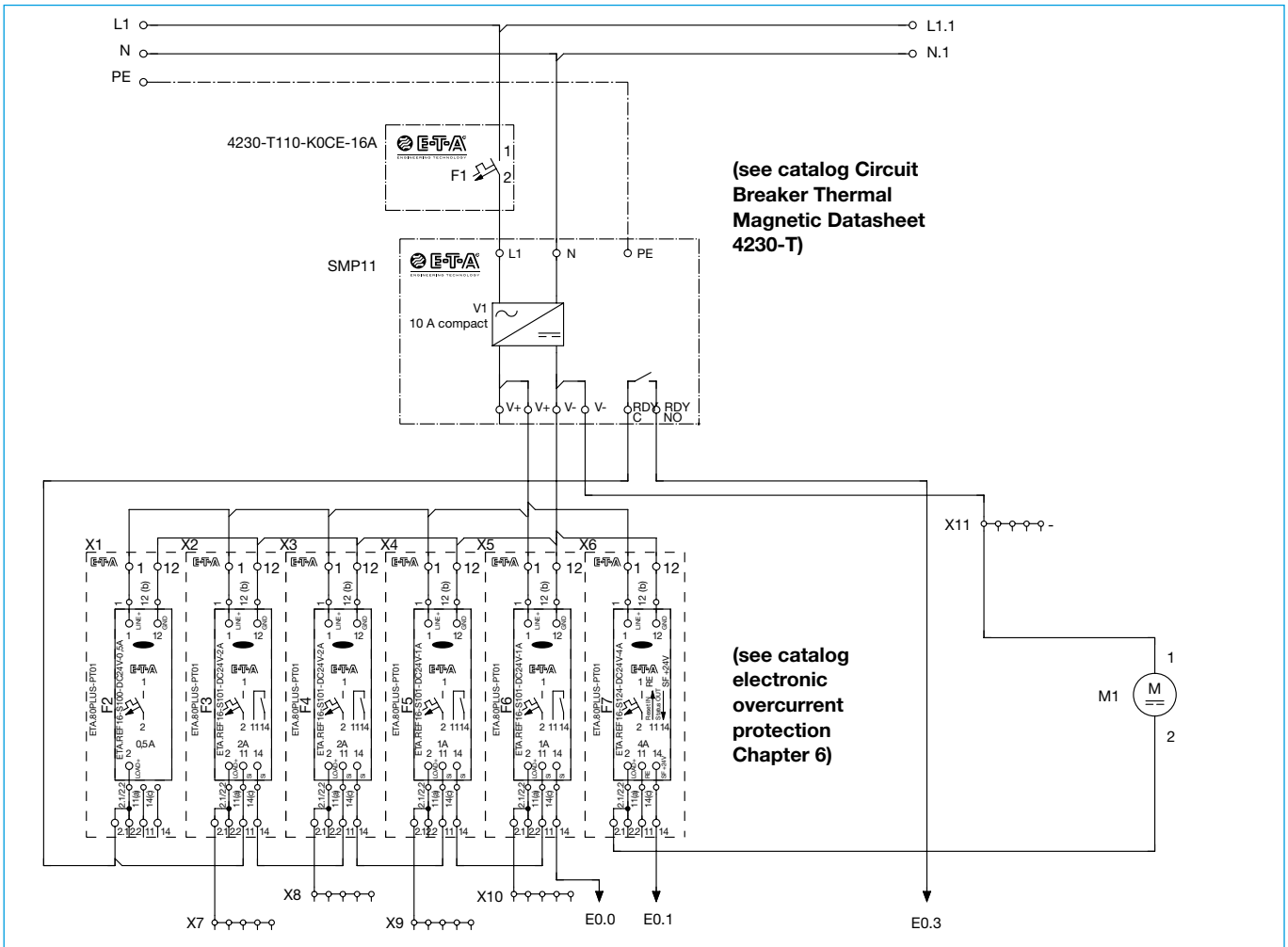

Current-voltage curve

current-voltage-curve short circuit → output REF16-S101-DC24V-6A

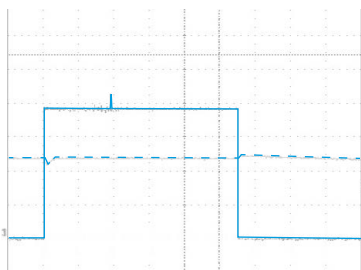

current: — 2 A / Div
 voltage: - - - 10 V / Div
 time 20 ms / Div.

Notes for installation

- The power distribution system must only be installed by qualified personnel.
- Only after expert installation must the device be supplied with power.
- The user has to ensure that the cable cross section complies with the applicable current rating.
- The national standards (e.g. for Germany DIN VDE 0100) have to be observed for installation and selection of feed and return cables.
- Recommended circuit breaker for the primary input cable protection: E-T-A type 4230 IN max. 20 A
- Recommended selective overcurrent protection for the secondary output protection: E-T-A types ESS., ESX., and REF...
- In addition special precautions must be taken in the system or machine (e.g. use of a safety PLC) which reliably prevent an automatic re-start of parts of the system (cf. Machinery Directive 2006/42/EU and EN 60204-1, Safety of Machinery). In the event of a failure (short circuit/overload) the load circuit will be disconnected by the circuit breaker/protector or the switched mode power supply.



All dimensions without tolerances are for reference only. E-T-A reserves the right change specifications at any time in the interest of improved design, performance and cost effectiveness, the right to make changes in these specifications without notice is reserved. Product markings may not be exactly as the ordering codes. Errors and omissions excepted.

X-ON Electronics

Largest Supplier of Electrical and Electronic Components

Click to view similar products for [DIN Rail Power Supplies](#) category:

Click to view products by [ETA](#) manufacturer:

Other Similar products are found below :

[PS-S6024](#) [DVP01PU-S](#) [DVP06AD-S](#) [DVP06XA-S](#) [DVDPNET-SL](#) [DVPDT01-S](#) [DVPPS01](#) [PS-6012](#) [PS9Z-5R1G](#) [PS-C24024](#)
[DVP08ST11N](#) [DVPACAB530](#) [DVPCOPM-SL](#) [DVPEN01-SL](#) [DVPPF01-S](#) [ADNB008-48-1PM-C](#) [ADNB017-24-1PM-C](#) [ADNB040-24-1PM-C](#) [ADNB034-12-1PM-C](#) [SS14011524](#) [PS-UPS40](#) [PSC-6024](#) [PSD-A60W12](#) [96PS-A120WDIN](#) [PSD-A60W48](#) [PSD-A40W12](#) [PSD-A40W24](#) [SMP21-L20-DC24V-5A](#) [PSD-A40W48](#) [S8T-DCBU-02](#) [PS-S4024](#) [NTPS-24-1.3](#) [ZI-20](#) [PST-96024](#) [S82YVSC4P](#) [PS-S4005](#) [PS-10024](#) [PS-S10024](#) [PS-C12024](#) [PSP-480S24](#) [PS-C48024](#) [PSC-2024](#) [PSC-4012](#) [PSC-4048](#) [PSC-9615](#) [PSC-15124](#) [PSC-15148](#) [PSC-24148](#) [PSC-48148](#) [TRIO-PS-2G/1AC/12DC/5/C2LP](#)