

3W, 0.85V Startup Voltage, Synchronous Step-Up Converter with Real-Shutdown and Short-Circuit Protection in SOT23-5

DESCRIPTION

The ETA1036 is a high efficiency synchronous step-up converter that can provide up to 3W of power to a boosted output from a low voltage source. Unlike most step-up converter, not only it starts up at a very low input voltage as low as 0.85V, it also incorporates circuits that disconnect the input from output, during shutdown, short-circuit, output current overloading, or other events when output is higher than the input. This eliminates the need for an external MOSFET and its control circuitry to disconnect the input from output, and provides robust output overload protection. The ETA1036 starts up from a voltage as low as 0.85V making it ideal for applications with single-cell or two-cell alkaline, NiCd, and NiMh batteries. A switching frequency of 2MHz minimizes solution footprint by allowing the use of tiny and low profile inductors and ceramic capacitors. An internal synchronous MOSFET provides highest efficiency and with a current mode control that is internally compensated, external parts count is reduced to minimal. ETA1036 is available in three output voltage options. They are 2.1V, 3.3V and 5V. It is housed in a tiny SOT23-5 package.

FEATURES

- Output Disconnect
- Short-circuit Protection
- 3W Output Power
- Output to Input Reversed Current Protection
- 0.85V Low Start-up Voltage
- VIN range from 0.6V to 4.5V
- Up to 96% Efficiency
- 40 μ A No load I_Q and light load PFM Mode
- Internal Synchronous Rectifier
- Current Mode control
- Logic Control Shutdown and Thermal shutdown
- SOT23-5 Package

APPLICATIONS

- USB OTG for MIDs, Smartphones
- Mobile back-up Battery Chargers
- Alkaline, NiCd, and NiMh batteries applications
- USB powered devices

ORDERING INFORMATION

PART #	Output Voltage	TOP MARK
ETA1036V50S2F	5.0V	CPYW
ETA1036V33S2F	3.3V	DzYW
ETA1036V21S2F	2.1V	DaYW

TYPICAL APPLICATION

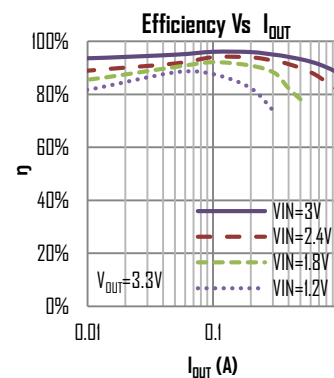
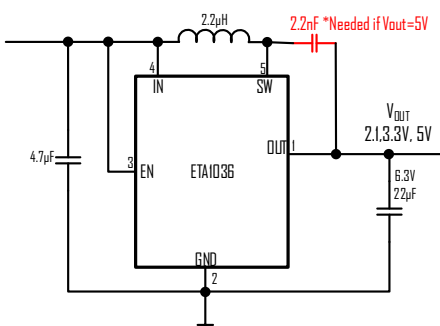

PIN CONFIGURATION

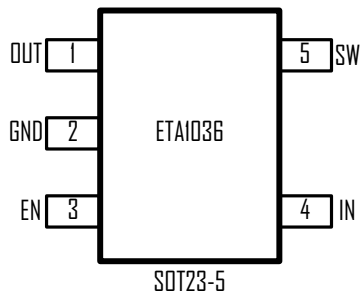

ABSOLUTE MAXIMUM RATINGS

(Note: Exceeding these limits may damage the device. Exposure to absolute maximum rating conditions for long periods may affect device reliability.)

SW/OUT Voltage.....	-0.3V to 5.5V
All Other PIN Voltages.....	-0.3V to V_{IN}
SW to ground current	Internally limited
Operating Temperature Range	-40°C to 85°C
Storage Temperature Range	-55°C to 150°C
Thermal Resistance	θ_{JA} θ_{JC}
SOT23-5.....	220.....110°C/W

ELECTRICAL CHARACTERISTICS

($V_{IN} = 1.8V$, $V_{OUT} = 3.3V$, unless otherwise specified. Typical values are at $T_A = 25^\circ C$.)

PARAMETER	CONDITIONS	MIN	TYP	MAX	UNITS
Minimum Input Voltage			0.6		V
Startup Voltage	$I_{OUT} = 0A$		0.85	1.1	V
Output Voltage	$V_{IN} = 1.8$		2.1		V
			3.3		
			5.0		
Quiescent Current at IN	No Switching		40		μA
Shutdown Supply Current at IN	$V_{EN} = GND$		0.5	5	μA
Switching Frequency	$V_{IN} < 4.3V$	1.3	2	2.2	MHz
Maximum Duty Cycle		90			%
NMOS Switch On Resistance	$I_{SW} = 100mA$		0.15	0.35	Ω
PMOS Switch On Resistance	$I_{SW} = 100mA$		0.15	0.35	Ω
NMOS Switch Current Limit		1.2	1.5		A
Start-up Current Limit			0.5		A
Output to Input Reverse Leakage Current	$V_{EN} = GND$, Measure at IN pin		0.1	5	μA
SW Leakage Current	$V_{OUT} = 5V, V_{SW} = 0$ or $5V, V_{EN} = GND$			10	μA
EN Input Current			0.1	1	μA
EN Input Low Voltage				0.3	V
EN Input High Voltage		0.6			V
Thermal Shutdown	Rising, Hysteresis= $10^\circ C$		165		$^\circ C$

PIN DESCRIPTION

PIN #	NAME	DESCRIPTION
1	OUT	Output pin. Bypass with a 22 μF or larger ceramic capacitor closely between this pin and GND
2	GND	Ground Pin
3	EN	Enable pin for the IC. Drive this pin to a voltage no higher than input voltage to enable the part, low to disable.
4	IN	Input Supply Voltage. Bypass with a 4.7 μF ceramic capacitor to GND
5	SW	Inductor Connection. Connect an inductor Between SW and the regulator output

TYPICAL CHARACTERISTICS

(Typical values are at $T_A = 25^{\circ}\text{C}$ unless otherwise specified.)

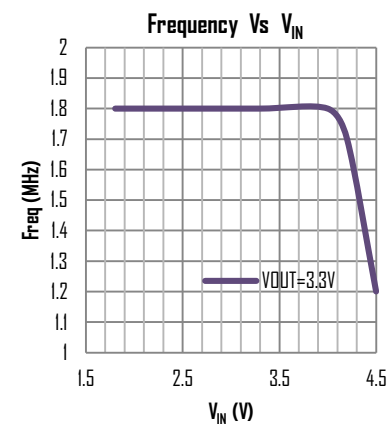
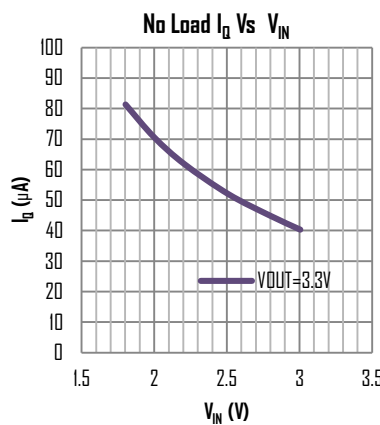
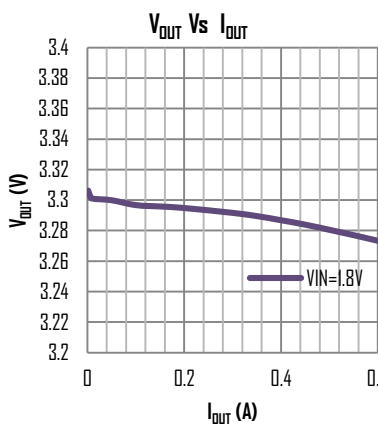
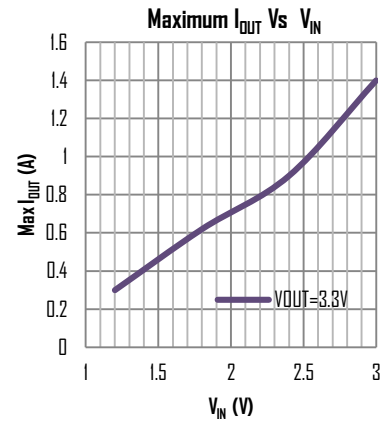
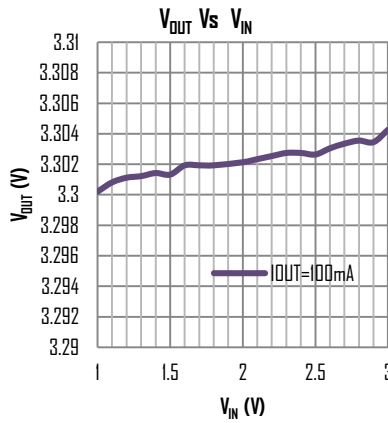
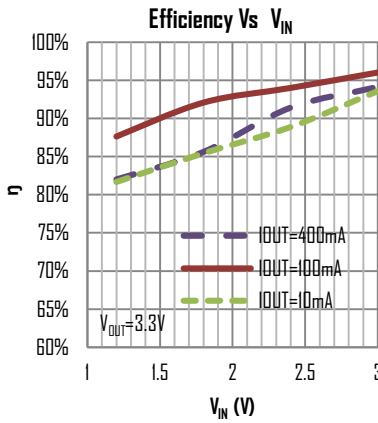
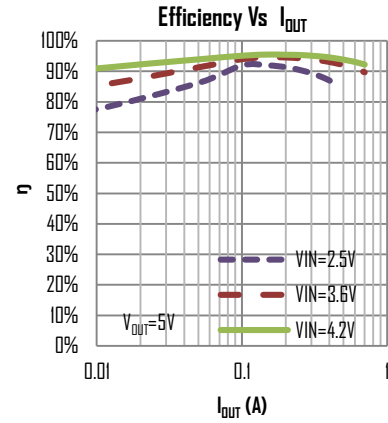
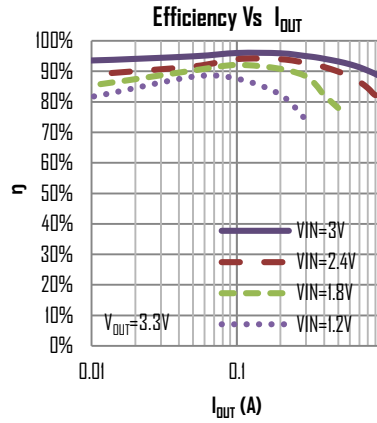
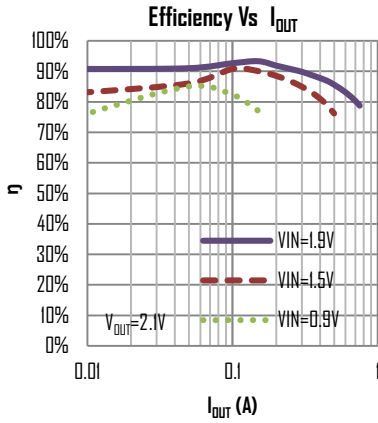

TYPICAL CHARACTERISTICS

(Typical values are at TA = 25°C unless otherwise specified.)

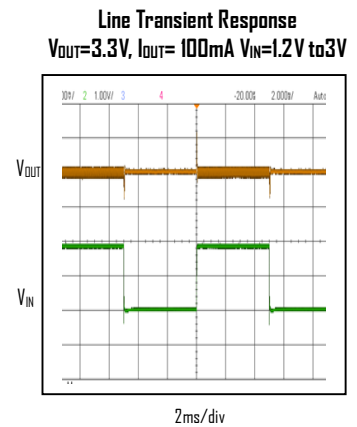
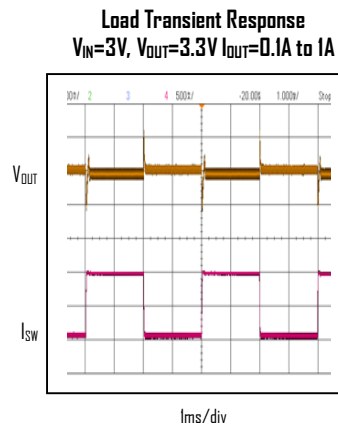
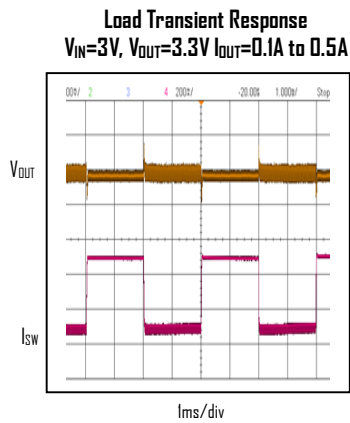
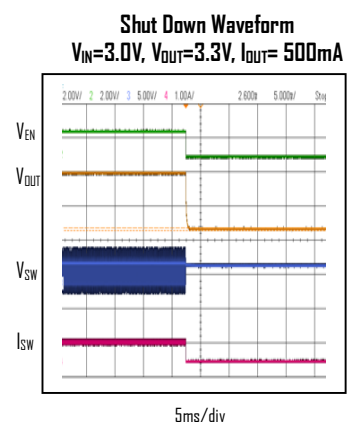
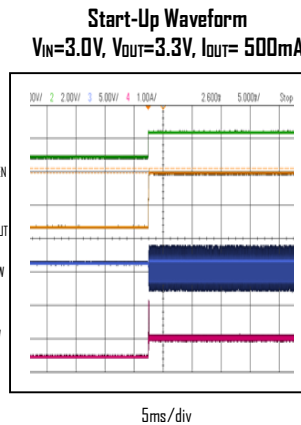
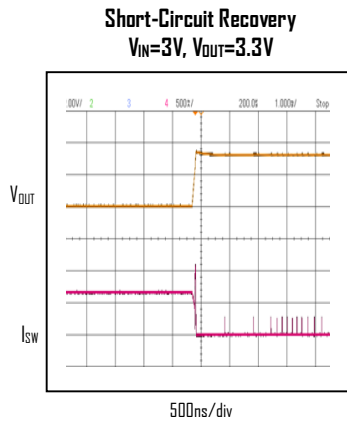
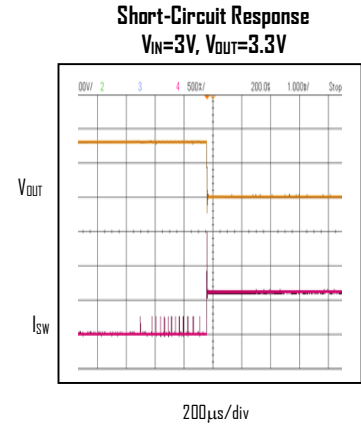
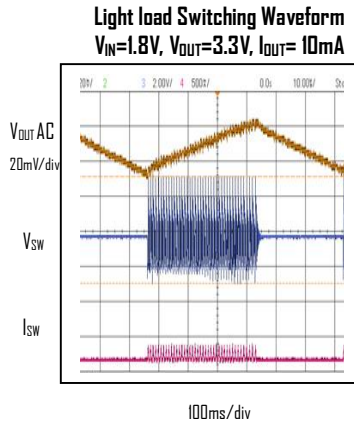
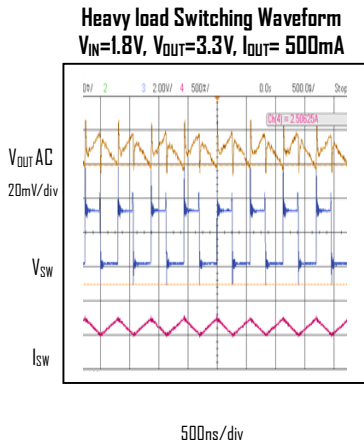

FUNCTIONAL DESCRIPTIONS

Loop Operation

The ETA1036 is a wide input range, high-efficiency, DC-to-DC step-up switching regulator, capable of delivering up to 3W of output power, integrated with a 150mΩ high side MOSFET and 150 mΩ synchronous rectifier. It uses a PWM current-mode control scheme. An error amplifier integrates error between the FB signal and the internal reference voltage. The output of the integrator is then compared to the sum of a current-sense signal and the slope compensation ramp. This operation generates a PWM signal that modulates the duty cycle of the power MOSFETs to achieve regulation for output voltage.

Light Load Operation

Traditionally, a fixed constant frequency PWM DC-DC regulator always switches even when the output load is small. When energy is shuffling back and forth through the power MOSFETs, power is lost due to the finite R_{DS(ON)}s of the MOSFETs and parasitic capacitances. At light load, this loss is prominent and efficiency is therefore very low. ETA1036 employs a proprietary control scheme that improves efficiency in this situation by enabling the device into a power save mode during light load, thereby extending the range of high efficiency operation.

Short-Circuit Protection

Unlike most step-up converters, the ETA1036 allows for short circuits on the output. In the event of a short circuit, the device first turns off the NMOS when the sensed current reaches the current limit. After V_{OUT} drops below V_{IN} the device then enters a linear charge period with the current limited same as with the start-up period. In addition, the thermal shutdown circuits disable switching if the die temperature rises above 165°C.

Down Mode ($V_{IN} > V_{OUT}$) Operation

The ETA1036 will continue to supply the output voltage even when the input voltage exceeds the output voltage. Since the PMOS no longer acts as a low-impedance switch in this mode, power dissipation increases within the IC to cause a sharp drop in efficiency. Limit the maximum output current to maintain an acceptable junction temperature.

BLOCK DIAGRAM

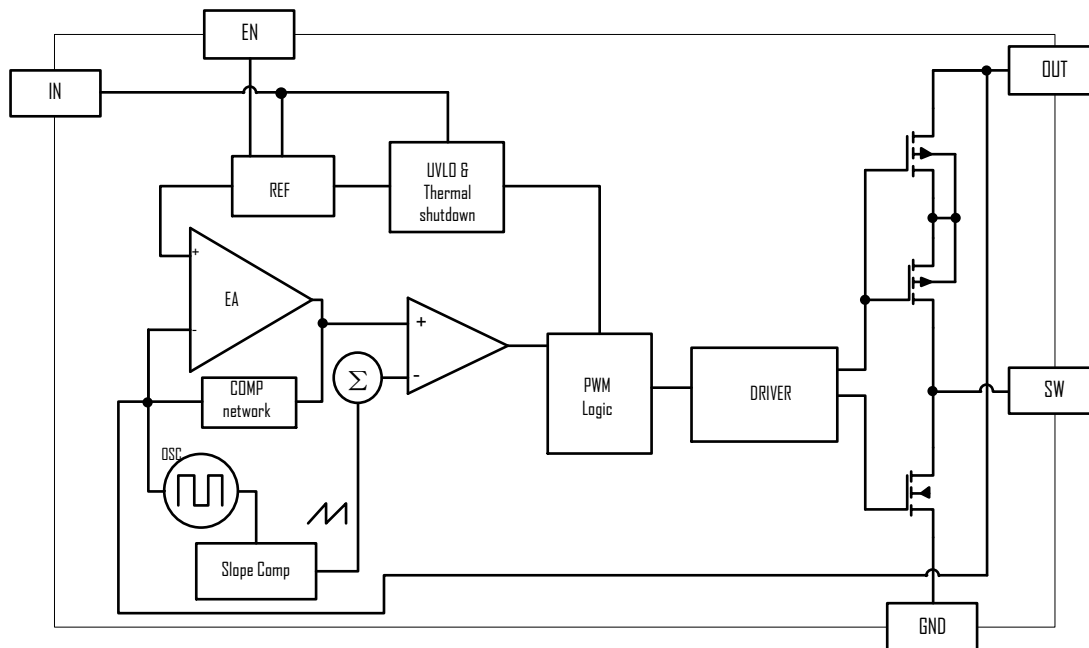

5V APPLICATIONS

For ETA1036-50, the 5V output voltage option, in order to maintain an acceptable peak voltage at SW, a small parallel capacitor snubber between SW and OUT is necessary, and an output cap of greater than 44µF is also required as shown in below figure.

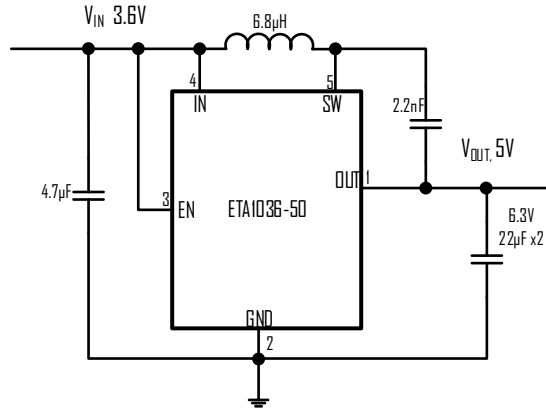

PCB LAYOUT

ETA1036's pin-out is perfectly designed to have peripheral passive devices laid closest to the IC to achieve the best performance. One should always keep Cout (22µF x 2) and Csw (2.2nF) as close to the ETA1036 as possible. A PCB layout is shown below for reference, for only one layer of PCB wiring needed.

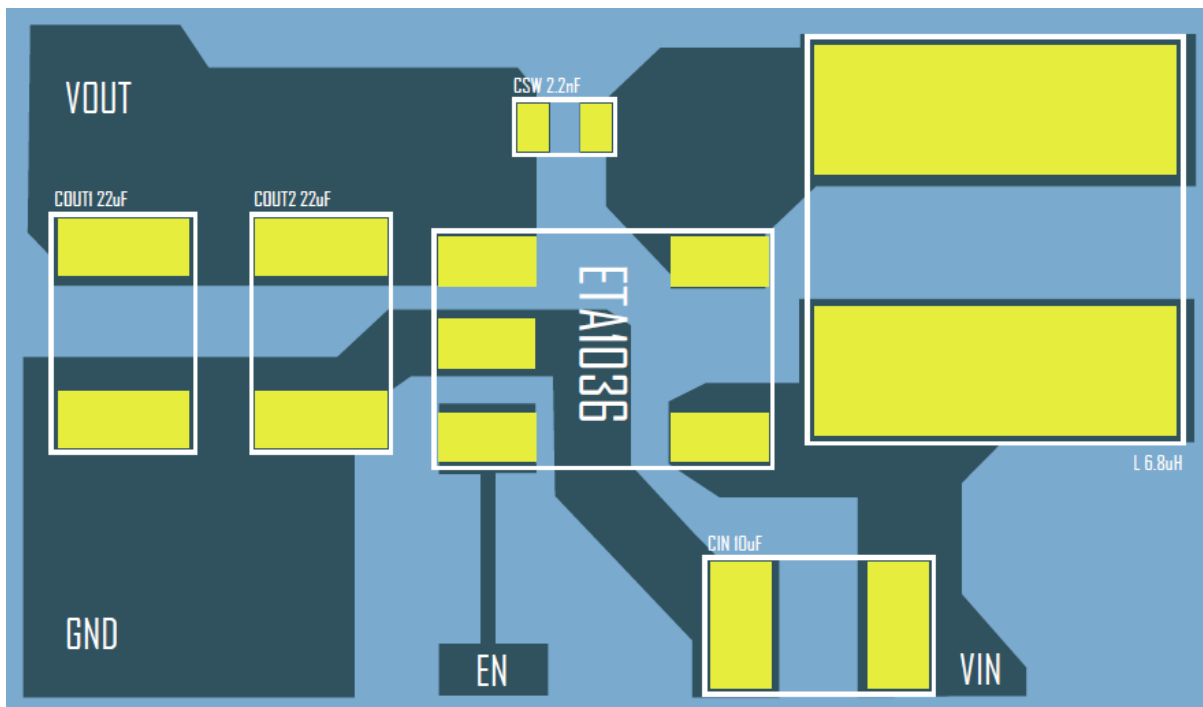

PACKAGE OUTLINE

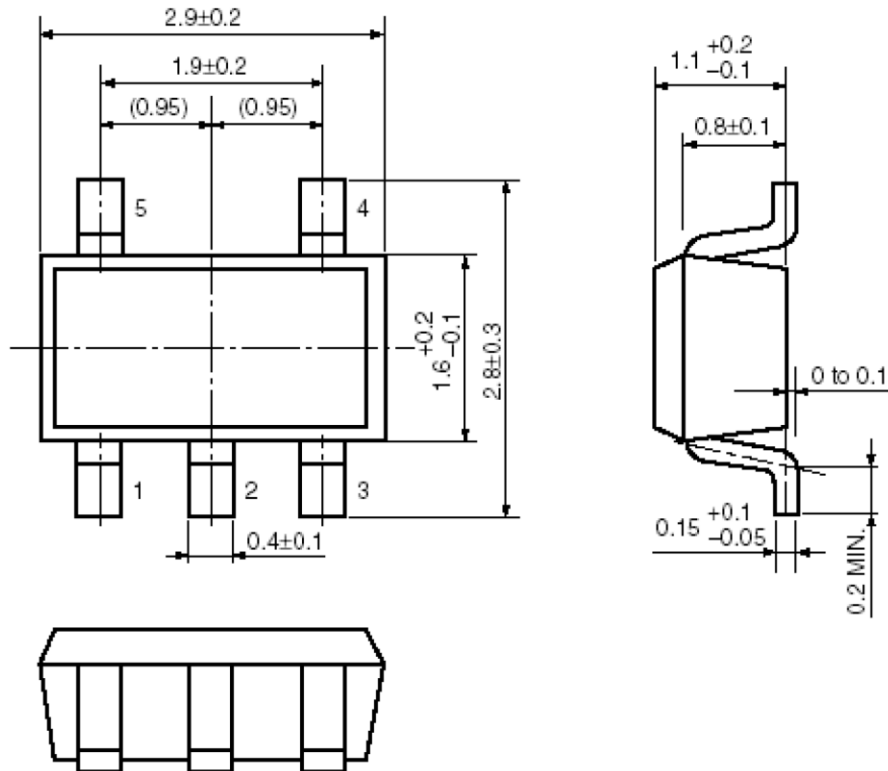

X-ON Electronics

Largest Supplier of Electrical and Electronic Components

Click to view similar products for [Isolated DC/DC Converters](#) category:

Click to view products by [etasolution](#) manufacturer:

Other Similar products are found below :

[PSL486-7LR](#) [Q48T30020-NBB0](#) [JAHW100Y1](#) [SPB05C-12](#) [SQ24S15033-PS0S](#) [CE-1003](#) [CE-1004](#) [MAU228](#) [J80-0041NL](#) [DFC15U48D15](#)
[XGS-1205](#) [06322](#) [SPB05B-15](#) [L-DA20](#) [DCG40-5G](#) [XKS-2405](#) [DPA423R](#) [vi-m13-cw-03](#) [VI-L53-CV](#) [24IBX15-50-0ZG](#) [HZZ01204-G](#)
[SPU02L-09](#) [SPU02M-09](#) [SPU02N-09](#) [QUINT4-BUFFER/24DC/40](#) [QUINT4-CAP/24DC/5/4KJ](#) [73-551-5039I](#) [DFC15U48D15G](#) [SEN-6471-](#)
[1EM](#) [AHV2815DF/HBB](#) [MI-LC21-IX](#) [PAH-48/8.5-D48NB1-C](#) [BM3020-7A](#) [QRS2050P025K00](#) [CM2320-9EG](#) [SKMW15F-05](#)
[V300A28H400BF3](#) [TEN 15-1223](#) [TEQ 100-2418WIR](#) [TEQ 160-7218WIR](#) [R05C05TE05S-R](#) [HQA2W085W033V-N07-S](#) [AM1SS-2405SJZ](#)
[AM2DS-1224SJZ](#) [AM2DS-2405DJZ](#) [AM10SBO-4824SNZ-B](#) [AM15E-2405S-NZ](#) [AM2DS-1212SJZ](#) [AM30SBO-4805SNZ-B](#)
[LT8301ES5#WTRPBF](#)