

3A, 18V High Efficiency Synchronous Step-Down Converter

DESCRIPTION

The ETA1485 is a wide input range, high-efficiency, DC-to-DC step-down switching regulator, capable of delivering up to 3A of output current. Current mode PWM control allows the use of small external components, such as ceramic input and output caps, as well as small inductors, while still providing low output ripples. On top of the integrated internal synchronous rectifier that eliminates external Schottky diode, ETA1485 also employs a proprietary control scheme that switches the device into a power save mode during light load, thereby extending the range of high efficiency operation. Therefore, ETA1485 is a much superior solution in comparison to other competitions in terms of efficiency and cost. Overall, ETA1485 is a highly efficient and robust solution for DC-DC step-down applications that requires wide input ranges. ETA1485 is available ESOP8 Packages.

APPLICATIONS

- LCD TVs
- Notebook computers
- FPGA power supplies

- LED drivers
- **FEATURES**
- **Wide Input Operating Range from 3.6V to 18V**
- **High Efficiency:**
 - **Up to 90%at Light Load**
- **Capable of Delivering 3A**
- **No External Schottky Diode Needed**
- Current Mode control
- 0.923V Reference for Low Output voltages
- Logic Control Shutdown
- Thermal shutdown and UVLO
- Available in ESOP8 Package

ORDERING INFORMATION

PART	PACKAGE PIN	TOP MARK
ETA1485E8A	ESOP8	ETA1485 YLLFF Date Code Product Number

TYPICAL APPLICATION

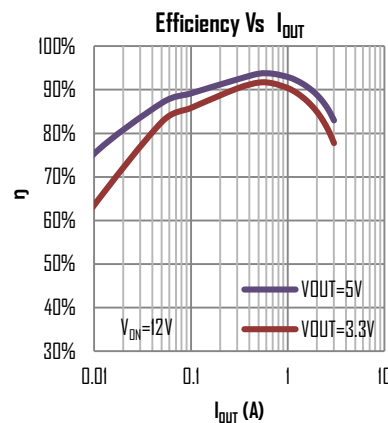
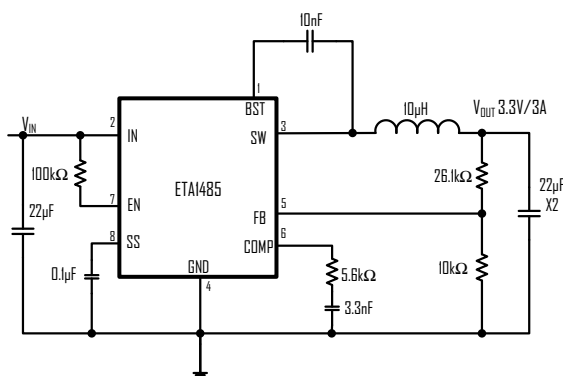

PIN CONFIGURATION

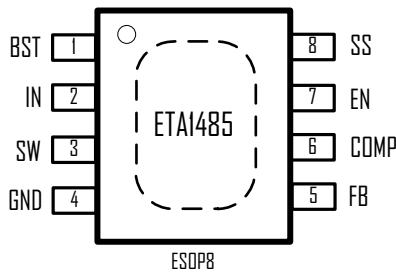

ABSOLUTE MAXIMUM RATINGS

(Note: Exceeding these limits may damage the device. Exposure to absolute maximum rating conditions for long periods may affect device reliability.)

IN Voltage.....	-0.3V to 20V
SW, EN Voltage.....	-0.3V to VIN+0.3V
BST Voltage.....	-0.3V to SW+6V
FB Voltage.....	-0.3V to 6V
SW to ground current	Internally limited
Operating Temperature Range	-40°C to 85°C
Storage Temperature Range	-55°C to 150°C

ELECTRICAL CHARACTERISTICS

(VIN = 12V, unless otherwise specified. Typical values are at TA = 25°C.)

PARAMETER	CONDITIONS	MIN	TYP	MAX	UNITS
Input Voltage Range		3.6		18	V
Input UVLO	Rising, Hysteresis=140mV		3.55		V
Input Supply Current	VFB = 1.0V		1		mA
Input Shutdown Current			6		µA
FB Feedback Voltage		0.904	0.923	0.942	V
FB Input Current			0.01		µA
Error Amp Transconductance			800		µS
Current Sense Transresistance			0.2		Ω
Switching Frequency			340		KHz
High side Switch On Resistance	ISW = 200mA		120		mΩ
Low side Switch On Resistance	ISW = 200mA		100		mΩ
High side Switch Current Limit			3.5		A
SW Leakage Current	VIN=12V, VSW=0 or 12V, EN= GND			10	µA
EN Input Current				1	µA
EN Input Low Voltage				0.6	V
EN Input High Voltage		1.3			V
Thermal Shutdown	Hysteresis=40°C		150		°C

PIN DESCRIPTION

PIN #	NAME	DESCRIPTION
1	BST	Bootstrap pin. Connect a 10nF capacitor from this pin to SW
2	IN	Supply Voltage. Bypass with a 22µF ceramic capacitor to GND
3	SW	Inductor Connection. Connect an inductor Between SW and the regulator output.
4	GND	Ground
5	FB	Feedback Input. Connect an external resistor divider from the output to FB and GND to set VOUT
6	COMP	Regulator Compensation. Connect series RC network to GND.
7	EN	Enable pin for the IC. Drive this pin to high to enable the part, low to disable.
8	SS	Soft start pin. Connect a 0.1 µF capacitor from this pin to GND

TYPICAL CHARACTERISTICS

(Typical values are at TA = 25°C unless otherwise specified.)

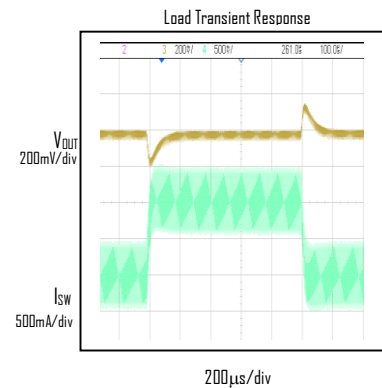
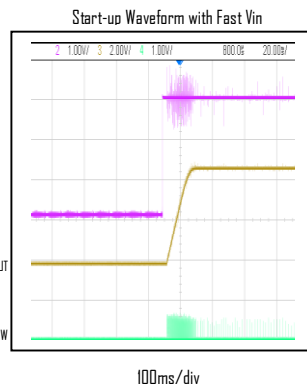
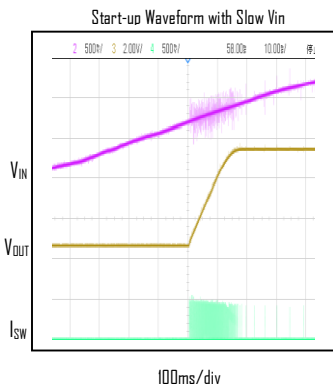
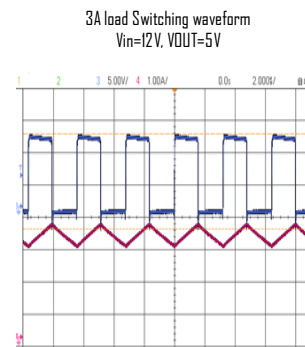
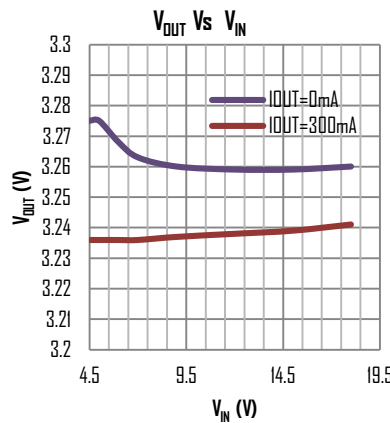
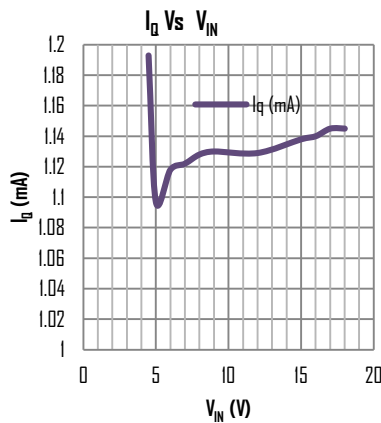
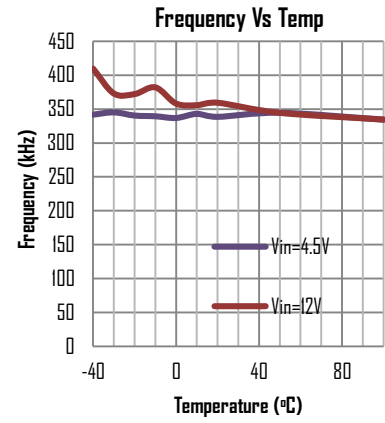
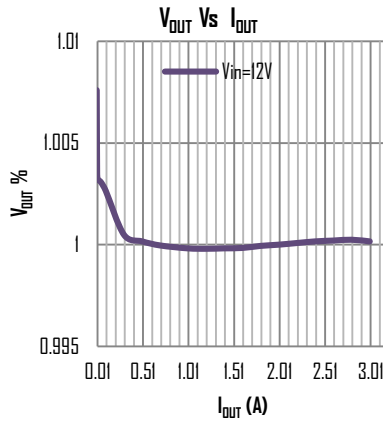
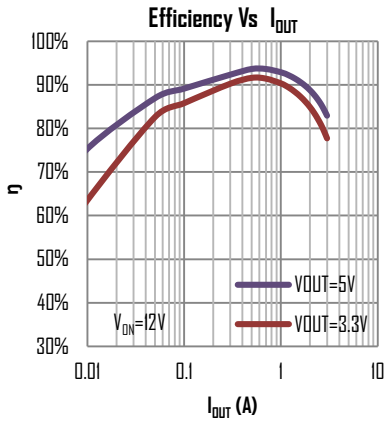

FUNCTIONAL DESCRIPTIONS

Loop Operation

The ETA1485 is a wide input range, high-efficiency, DC-to-DC step-down switching regulator, capable of delivering up to 3A of output current, integrated with a 110m Ω synchronous MOSFET, eliminating the need for external diode. It uses a PWM current-mode control scheme. An error amplifier integrates error between the FB signal and the internal reference voltage. The output of the integrator is then compared to the sum of a current-sense signal and the slope compensation ramp. This operation generates a PWM signal that modulates the duty cycle of the power MOSFETs to achieve regulation for output voltage.

Current Limit

There is a cycle-by-cycle current limit on the high-side MOSFET of 3A(typ). When the current flowing out of SW exceeds this limit, the high-side MOSFET turns off and the synchronous rectifier turns on. Unlike the traditional method of current limiting by limiting the voltage at the compensation pin, which usually has large variation due to duty cycle variance, this type of peak current limiting scheme provides a relatively more accurate limit for output current, thereby lowering the requirements for system design.

Light Load Operation

Traditionally, a fixed constant frequency PWM DC-DC regulator always switches even when the output load is small. When energy is shuffling back and forth through the power MOSFETs, power is lost due to the finite RDSONs of the MOSFETs and parasitic capacitances. At light load, this loss is prominent and efficiency is therefore very low. ETA1485 employs a proprietary control scheme that improves efficiency in this situation by enabling the device into a power save mode during light load, thereby extending the range of high efficiency operation.

APPLICATION INFORMATION

Components Selection

V _{OUT} (V)	C _{OUT} (μ F)	L (μ H)
8	22x2	22
5	22x2	15
3.3	22x2	10
2.5	22x2	6.8
1.8	22x2	4.7
1.2	22x2	3.3

PACKAGE OUTLINE

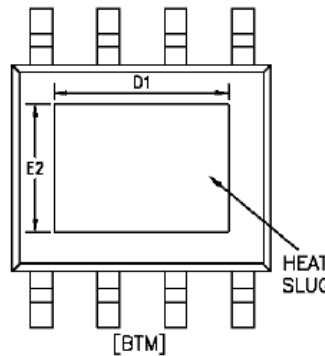
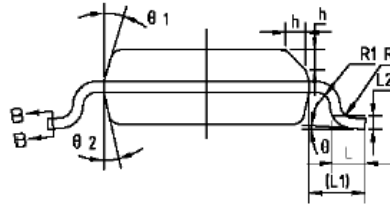
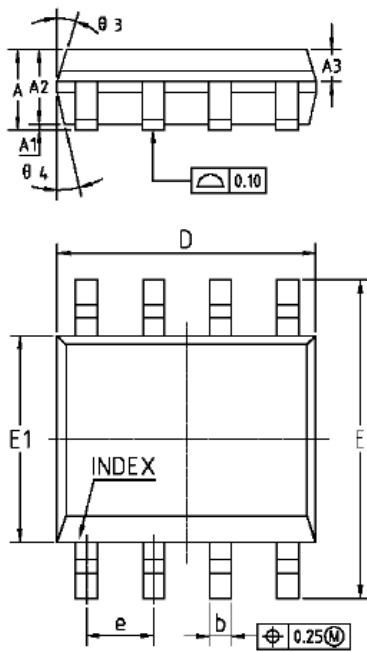

COMMON DIMENSIONS
(UNITS OF MEASURE=MILLIMETER)

SYMBOL	MIN	NOM	MAX
A	1.35	1.55	1.75
A1	0	0.10	0.15
A2	1.25	1.40	1.65
A3	0.90	0.80	0.70
b	0.38	-	0.51
b1	0.37	0.42	0.47
c	0.17	-	0.25
c1	0.17	0.20	0.23
D	4.80	4.90	5.00
D1	3.10	3.30	3.50
E	5.80	6.00	6.20
E1	3.80	3.90	4.00
E2	2.20	2.40	2.60
e	1.27BSC		
L	0.45	0.60	0.80
L1	1.04REF		
L2	0.25BSC		
R	0.07	-	-
R1	0.07	-	-
h	0.30	0.40	0.50
theta	0°	-	8°
theta 1	15°	17°	19°
theta 2	11°	13°	15°
theta 3	15°	17°	19°
theta 4	11°	13°	15°

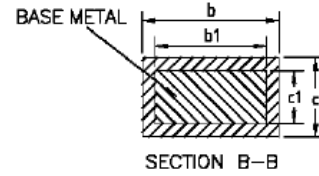

NOTES:
ALL DIMENSIONS REFER TO JEDEC STANDARD MS-012 AA
DO NOT INCLUDE MOLD FLASH OR PROTRUSIONS.

X-ON Electronics

Largest Supplier of Electrical and Electronic Components

Click to view similar products for [Isolated DC/DC Converters](#) category:

Click to view products by [etasolution](#) manufacturer:

Other Similar products are found below :

[PSL486-7LR](#) [Q48T30020-NBB0](#) [JAHW100Y1](#) [SPB05C-12](#) [SQ24S15033-PS0S](#) [CE-1003](#) [CE-1004](#) [MAU228](#) [J80-0041NL](#) [DFC15U48D15](#)
[XGS-1205](#) [06322](#) [SPB05B-15](#) [L-DA20](#) [DCG40-5G](#) [XKS-2405](#) [DPA423R](#) [vi-m13-cw-03](#) [VI-L53-CV](#) [24IBX15-50-0ZG](#) [HZZ01204-G](#)
[SPU02L-09](#) [SPU02M-09](#) [SPU02N-09](#) [QUINT4-BUFFER/24DC/40](#) [QUINT4-CAP/24DC/5/4KJ](#) [73-551-5039I](#) [DFC15U48D15G](#) [SEN-6471-](#)
[1EM](#) [AHV2815DF/HBB](#) [MI-LC21-IX](#) [PAH-48/8.5-D48NB1-C](#) [BM3020-7A](#) [QRS2050P025K00](#) [CM2320-9EG](#) [SKMW15F-05](#)
[V300A28H400BF3](#) [TEN 15-1223](#) [TEQ 100-2418WIR](#) [TEQ 160-7218WIR](#) [R05C05TE05S-R](#) [HQA2W085W033V-N07-S](#) [AM1SS-2405SJZ](#)
[AM2DS-1224SJZ](#) [AM2DS-2405DJZ](#) [AM10SBO-4824SNZ-B](#) [AM15E-2405S-NZ](#) [AM2DS-1212SJZ](#) [AM30SBO-4805SNZ-B](#)
[LT8301ES5#WTRPBF](#)