

42V Input Standoff Voltage, 1A Step-Down Converter in SOT23-6

DESCRIPTION

The ETA2842 is a wide input range, high-efficiency, and high frequency DC-to-DC step-down switching regulator, capable of delivering up to 1A of output current. With a fixed switching frequency of 650KHz, this current mode PWM controlled converter allows the use of small external components, such as ceramic input and output caps, as well as small inductors. ETA2842 also employs a proprietary control scheme that switches the device into a power save mode during light load, thereby extending the range of high efficiency operation. An OVP function protects the IC itself and its downstream system against input voltage surges. With this OVP function, the IC can stand off input voltage as high as 42V, making it an ideal solution for industrial applications such as smart meters as well as automotive applications.

In automotive systems, power comes from the battery, with its voltage typically between 9V and 24V. Including cold crank and double battery jump-starts, the minimum input voltage may be as low as 4V and the maximum up to 36V, with even higher transient voltages. With these high input voltages, linear regulators cannot be used for high supply currents without overheating the regulator. Instead, high efficiency switching regulators such as ETA2842 must be used to minimize thermal dissipation. ETA2842 is available SOT23-6 Packages.

FEATURES

- Wide Input Operating Range from 4V to 38V
- Standoff Input Voltage: 42V
- Output up to 12V
- High Efficiency at 12V In 5V Out: Up to 91%:
- High Efficiency PFM mode at light load
- Capable of Delivering 1A
- No External Compensation Needed
- Current Mode control
- Logic Control Shutdown
- Thermal shutdown and UVLO
- Available in SOT23-6 Package

APPLICATIONS

- Smart Meters
- Industrial Applications
- Automotive Applications

ORDERING INFORMATION

PART #	PACKAGE PIN	TOP MARK
ETA2842S2G	SOT23-6	EGYW └─ Date Code └─ Product Number

TYPICAL APPLICATION

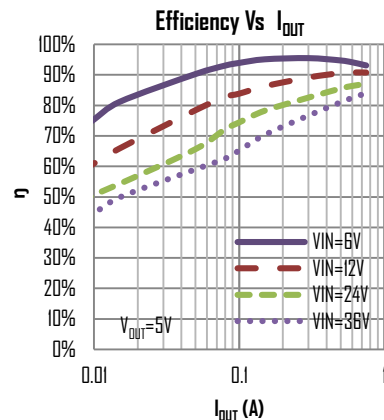
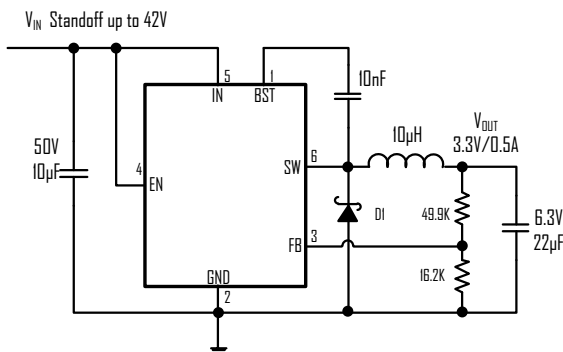

PIN CONFIGURATION

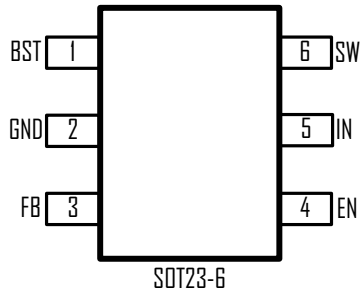

ABSOLUTE MAXIMUM RATINGS

(Note: Exceeding these limits may damage the device. Exposure to absolute maximum rating conditions for long periods may affect device reliability.)

IN Voltage.....	-0.3V to 42V
SW, EN Voltage.....	-0.3V to VIN+0.3V
BST Voltage.....	-0.3V to SW+6V
FB Voltage.....	-0.3V to 6V
SW to ground current	Internally limited
Operating Temperature Range	-40°C to 85°C
Storage Temperature Range	-55°C to 150°C
Thermal Resistance	θ_{JA} θ_{JC}
SOT23-6.....	220.....110.....°C/W

ELECTRICAL CHARACTERISTICS

(VIN = 12V, unless otherwise specified. Typical values are at TA = 25°C.)

PARAMETER	CONDITIONS	MIN	TYP	MAX	UNITS
Input Standoff Voltage		42			V
Input Voltage Range		4		38	V
Input UVLO	Rising, Hysteresis=140mV		3.80		V
Input OVP	Rising, Hysteresis=1.3V		38		V
Input Supply Current	VFB = 0.85V		0.6		mA
Input Shutdown Current			6		μA
FB Feedback Voltage			0.800		V
FB Input Current			0.01		μA
Switching Frequency			650		KHz
Maximum Duty Cycle		90			%
FoldBack Frequency	VFB = 0V		60		KHz
High side Switch On Resistance	ISW = 200mA		400		mΩ
High side Switch Current Limit			1.2		A
SW Leakage Current	VIN=12V, VSW=0, EN= GND			10	μA
EN Input Current	VIN=12V, VEN=5V		1	5	μA
EN Input Low Voltage	Rising, Hysteresis=100mV	0.8	1.1	1.4	V
Thermal Shutdown	Hysteresis=40°C		150		°C

PIN DESCRIPTION

PIN #	NAME	DESCRIPTION
1	BST	Bootstrap pin. Connect a 10nF capacitor from this pin to SW
2	GND	Ground
3	FB	Feedback Input. Connect an external resistor divider from the output to FB and GND to set VOUT
4	EN	Enable pin for the IC. Drive this pin high to enable the part, low to disable.
5	IN	Supply Voltage. Bypass with a 10μF ceramic capacitor to GND
6	SW	Inductor Connection. Connect an inductor Between SW and the regulator output.

TYPICAL CHARACTERISTICS

(Typical values are at $T_A = 25^\circ\text{C}$ unless otherwise specified.)

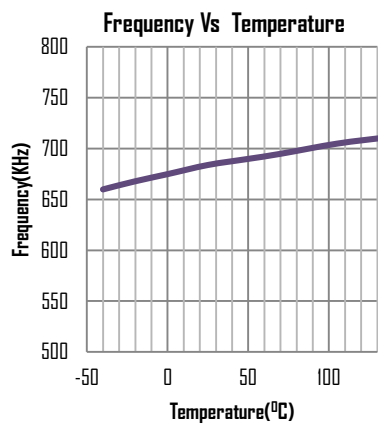
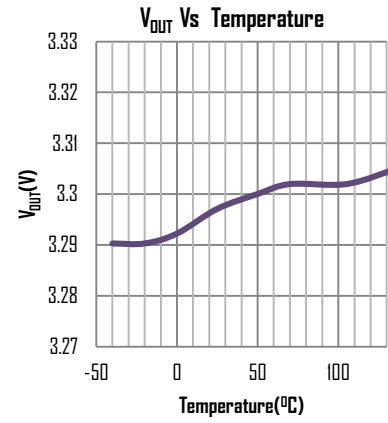
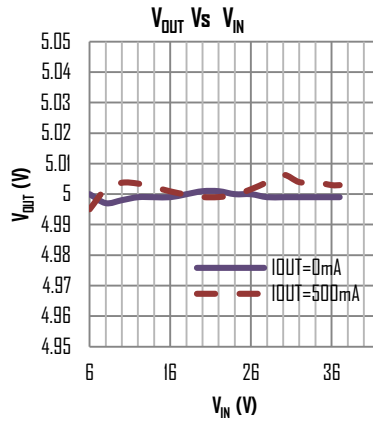
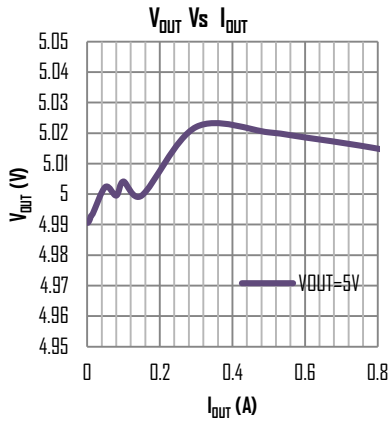
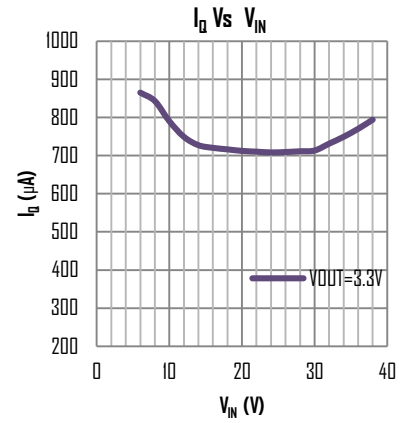
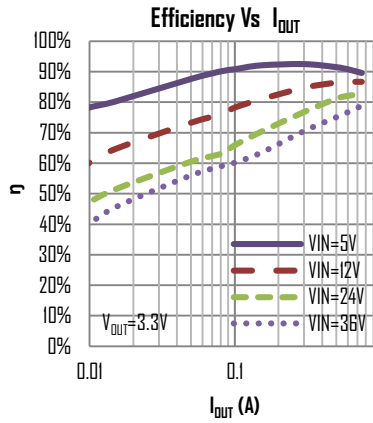
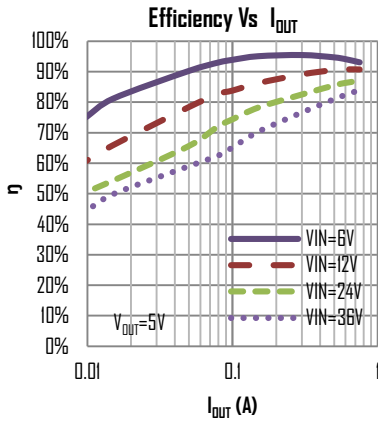

TYPICAL CHARACTERISTICS

(Typical values are at $T_A = 25^\circ\text{C}$ unless otherwise specified.)

Start-up Waveform with EN
 $V_{IN}=12\text{V}, V_{OUT}=5\text{V}, I_{OUT}=0\text{A}$

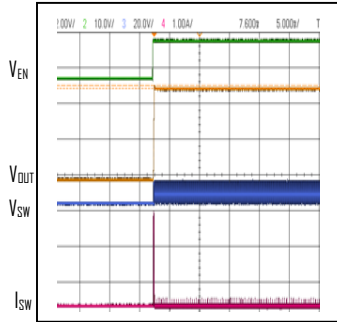

5ms/div

Start-up Waveform with EN= V_{IN}
 $V_{IN}=12\text{V}, V_{OUT}=5\text{V}, I_{OUT}=0\text{A}$

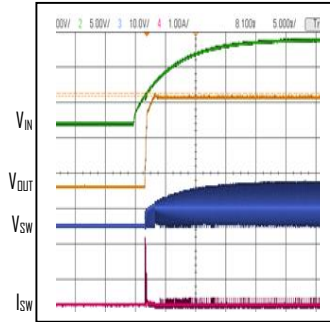

5ms/div

Shutdown Waveform with EN
 $V_{IN}=30\text{V}, V_{OUT}=5\text{V}, I_{OUT}=0.5\text{A}$

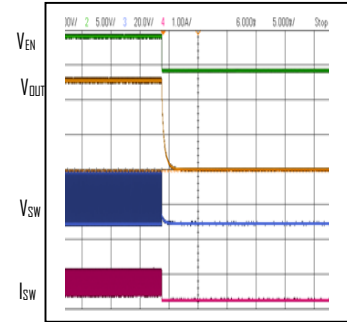

5ms/div

Switching Waveform
 $V_{IN}=12\text{V}, V_{OUT}=5\text{V}, I_{OUT}=0.1\text{A}$

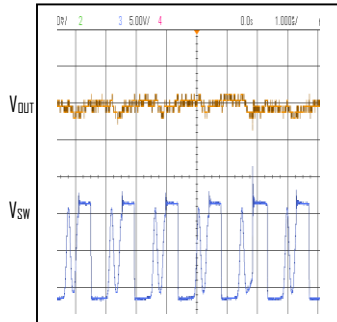

5ms/div

Switching Waveform
 $V_{IN}=12\text{V}, V_{OUT}=5\text{V}, I_{OUT}=0.3\text{A}$

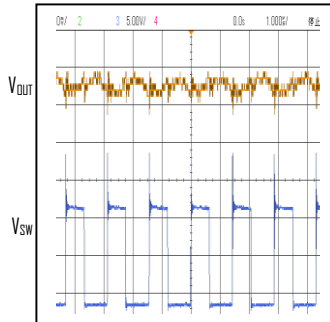

5ms/div

Load Transient Response
 $V_{IN}=12\text{V}, V_{OUT}=3.3\text{V}, I_{OUT}=0$ to 0.5A

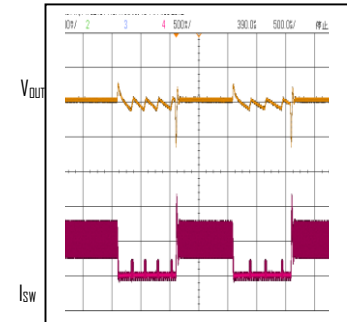

5ms/div

Load Transient Response
 $V_{IN}=12\text{V}, V_{OUT}=5\text{V}, I_{OUT}=0$ to 0.5A

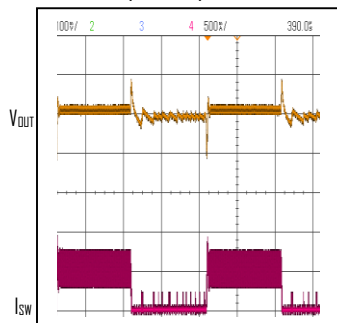

5ms/div

Short-Circuit Response
 $V_{IN}=24\text{V}, V_{OUT}=5\text{V}, I_{OUT}=0\text{A}$ to Short

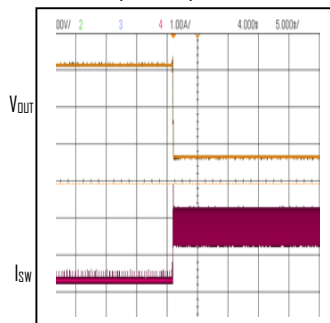

5ms/div

Short-Circuit Recovery
 $V_{IN}=24\text{V}, V_{OUT}=5\text{V}, I_{OUT}=\text{Short}$ to 0A

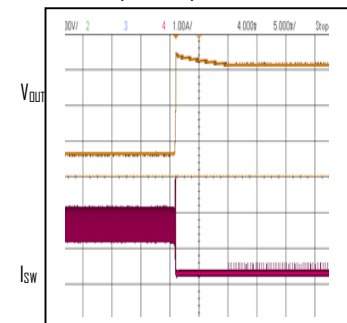

5ms/div

FUNCTIONAL DESCRIPTIONS

Loop Operation

The ETA2842 is a wide input range, high-efficiency, DC-to-DC step-down switching regulator, capable of delivering up to 1A of output current, integrated with a 400mΩ high side MOSFET. It uses a PWM current-mode control scheme. An error amplifier integrates error between the FB signal and the internal reference voltage. The output of the integrator is then compared to the sum of a current-sense signal and the slope compensation ramp. This operation generates a PWM signal that modulates the duty cycle of the power MOSFETs to achieve regulation for output voltage.

Light Load Operation

Traditionally, a fixed constant frequency PWM DC-DC regulator always switches even when the output load is small. When energy is shuffling back and forth through the power MOSFETs, power is lost due to the finite RDS(ON)s of the MOSFETs and parasitic capacitances. At light load, this loss is prominent and efficiency is therefore very low. ETA2842 employs a proprietary control scheme that improves efficiency in this situation by enabling the device into a power save mode during light load, thereby extending the range of high efficiency operation.

BLOCK DIAGRAM

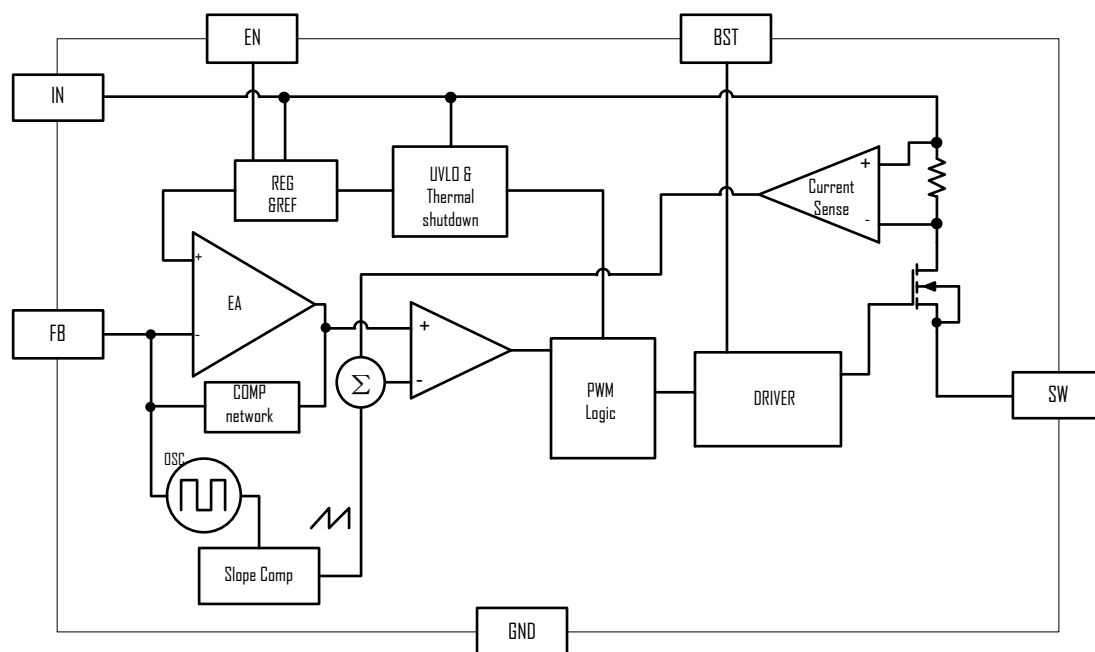

APPLICATION INFORMATION

Setting Output Voltages

Output voltages are set by external resistors. The FB threshold is 0.8V.

$$R_{TOP} = R_{BOTTOM} \times [(V_{OUT} / 0.8) - 1]$$

Inductor Selection

The peak-to-peak ripple is limited to 30% of the maximum output current. This places the peak current far enough from the minimum overcurrent trip level to ensure reliable operation while providing enough current ripples for the current mode converter to operate stably. In this case, for 1A maximum output current, the maximum inductor ripple current is 300 mA. The inductor size is estimated as following equation:

$$L_{IDEAL} = (V_{IN(MAX)} - V_{OUT}) / I_{RIPPLE} * D_{MIN} * (1 / F_{OSC})$$

Therefore, for $V_{OUT} = 5V$,

The inductor value is calculated to be $L = 13\mu H$.

Choose 10 μH or 15 μH

For $V_{OUT} = 3.3V$,

The inductor value is calculated to be $L = 9.2\mu H$.

Choose 10 μH

Output Capacitor Selection

For most applications a nominal 22 μF or larger capacitor is suitable. The ETA2842 internal compensation is designed for a fixed corner frequency that is equal to

$$f_C = \frac{1}{2 * \pi * \sqrt{C_{OUT} * L}} = 8.7KHz$$

For example, for $V_{OUT} = 5V$, $L = 15\mu H$, $C_{OUT} = 22\mu F$.

The output capacitor keeps output ripple small and ensures control-loop stability. The output capacitor must also have low impedance at the switching frequency. Ceramic, polymer, and tantalum capacitors are suitable, with ceramic exhibiting the lowest ESR and high-frequency impedance. Output ripple with a ceramic output capacitor is approximately as follows:

$$V_{RIPPLE} = I_{L(PEAK)} [1 / (2\pi * f_{OSC} * C_{OUT})]$$

If the capacitor has significant ESR, the output ripple component due to capacitor ESR is as follows:

$$V_{RIPPLE(ESR)} = I_{L(PEAK)} * ESR$$

Input Capacitor Selection

The input capacitor in a DC-to-DC converter reduces current peaks drawn from the battery or other input power source and reduces switching noise in the controller. The impedance of the input capacitor at the switching frequency should be less than that of the input source so high-frequency switching currents do not pass through the input source. The output capacitor keeps output ripple small and ensures control-loop stability.

Components Selection

V_{OUT} (V)	C_{OUT} (μF)	L (μH)
8	22	15 to 22
5	22	10 to 15
3.3	22	6.8 to 10

PACKAGE OUTLINE

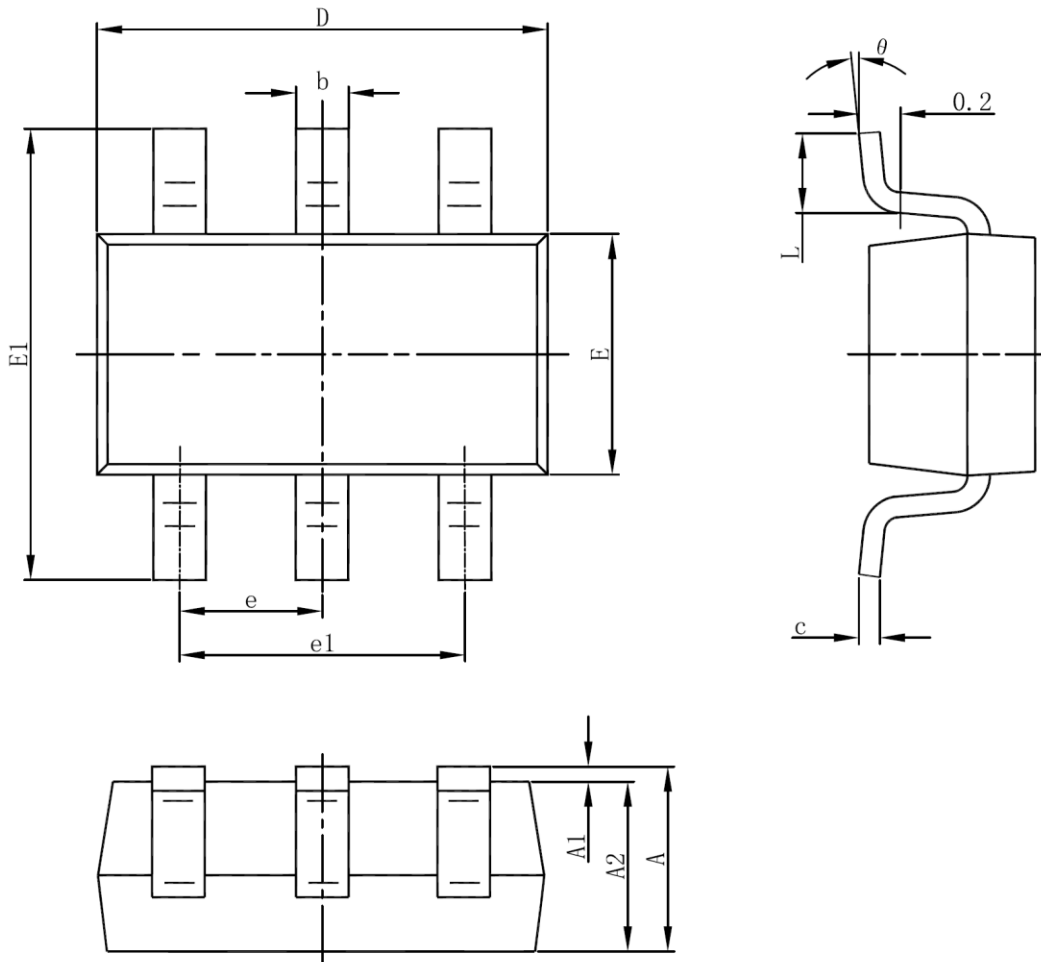

Symbol	Dimensions In Millimeters		Dimensions In Inches	
	Min	Max	Min	Max
A	1.050	1.250	0.041	0.049
A1	0.000	0.100	0.000	0.004
A2	1.050	1.150	0.041	0.045
b	0.300	0.500	0.012	0.020
c	0.100	0.200	0.004	0.008
D	2.820	3.020	0.111	0.119
E	1.500	1.700	0.059	0.067
E1	2.650	2.950	0.104	0.116
e	0.950(BSC)		0.037(BSC)	
e1	1.800	2.000	0.071	0.079
L	0.300	0.600	0.012	0.024
θ	0°	8°	0°	8°

X-ON Electronics

Largest Supplier of Electrical and Electronic Components

Click to view similar products for [Isolated DC/DC Converters](#) category:

Click to view products by [etasolution](#) manufacturer:

Other Similar products are found below :

[PSL486-7LR](#) [Q48T30020-NBB0](#) [JAHW100Y1](#) [SPB05C-12](#) [SQ24S15033-PS0S](#) [CE-1003](#) [CE-1004](#) [MAU228](#) [J80-0041NL](#) [DFC15U48D15](#)
[XGS-1205](#) [06322](#) [SPB05B-15](#) [L-DA20](#) [DCG40-5G](#) [XKS-2405](#) [DPA423R](#) [vi-m13-cw-03](#) [VI-L53-CV](#) [24IBX15-50-0ZG](#) [HZZ01204-G](#)
[SPU02L-09](#) [SPU02M-09](#) [SPU02N-09](#) [QUINT4-BUFFER/24DC/40](#) [QUINT4-CAP/24DC/5/4KJ](#) [73-551-5039I](#) [DFC15U48D15G](#) [SEN-6471-](#)
[1EM](#) [AHV2815DF/HBB](#) [MI-LC21-IX](#) [PAH-48/8.5-D48NB1-C](#) [BM3020-7A](#) [QRS2050P025K00](#) [CM2320-9EG](#) [SKMW15F-05](#)
[V300A28H400BF3](#) [TEN 15-1223](#) [TEQ 100-2418WIR](#) [TEQ 160-7218WIR](#) [R05C05TE05S-R](#) [HQA2W085W033V-N07-S](#) [AM1SS-2405SJZ](#)
[AM2DS-1224SJZ](#) [AM2DS-2405DJZ](#) [AM10SBO-4824SNZ-B](#) [AM15E-2405S-NZ](#) [AM2DS-1212SJZ](#) [AM30SBO-4805SNZ-B](#)
[LT8301ES5#WTRPBF](#)