

1.5MHz 1.2A Step-Down Converter in SOT23-5 Package

DESCRIPTION

The ETA3406 is a high-efficiency, DC-to-DC step-down switching regulator, capable of delivering up to 1.2A of output current. The devices operate from an input voltage range of 2.6V to 5.5V and provide output voltages from 0.6V to V_{IN} , making the ETA3406 ideal for low voltage power conversions. Running at a fixed frequency of 1.5MHz allows the use of small inductance value and low DCR inductors, thereby achieving higher efficiencies. Other external components, such as ceramic input and output caps, can also be small due to higher switching frequency, while maintaining exceptional low noise output voltages. Built-in EMI reduction circuitry makes this converter ideal power supply for RF applications. Internal soft-start control circuitry reduces inrush current. Short-circuit and thermal-overload protection improves design reliability.

ETA3406 is housed in a tiny SOT23-5L package

FEATURES

- ◆ Up to 1.2A Max Output Current
- ◆ 1.5MHz Frequency
- ◆ Light Load Operation
- ◆ Internal Compensation
- ◆ Tiny SOT23-5L Package

APPLICATIONS

- ◆ USB ports/Hubs
- ◆ Hot Swaps
- ◆ Cellphones
- ◆ Tablet PC
- ◆ Set Top Boxes

ORDERING INFORMATION

PART	PACKAGE PIN	TOP MARK
ETA3406S2F	SOT23-5	AHYW <div style="margin-left: 20px;">└── Date Code</div> <div style="margin-left: 20px;">└── Product Number</div>

TYPICAL APPLICATION

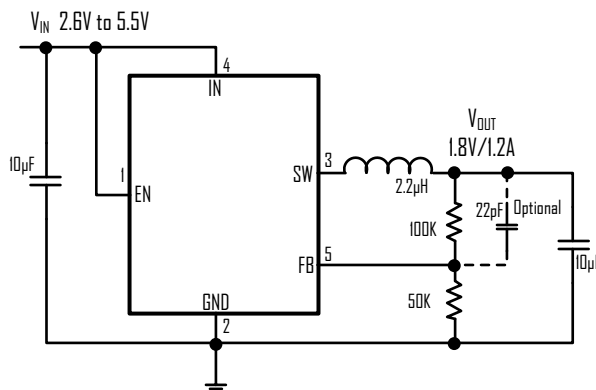

1.8V/1.2A 1.5MHz Step-Down Converter

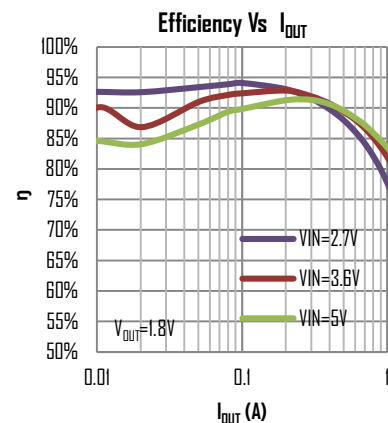

PIN CONFIGURATION

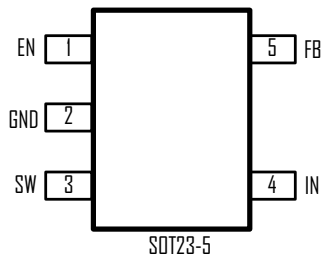

ABSOLUTE MAXIMUM RATINGS

(Note: Exceeding these limits may damage the device. Exposure to absolute maximum rating conditions for long periods may affect device reliability.)

IN, SW, FB, EN Voltage	-0.3V to 7V
SW to ground current	Internally limited
Maximum Power Dissipation.....	400mW
Operating Temperature Range	-40°C to 85°C
Storage Temperature Range	-55°C to 150°C
Thermal Resistance	θ_{JA} θ_{JC}
SOT23-5.....	220.....110°C/W

ELECTRICAL CHARACTERISTICS

($V_{IN} = 3.6V$, unless otherwise specified. Typical values are at $T_A = 25^{\circ}C$.)

PARAMETER	CONDITIONS	MIN	TYP	MAX	UNITS
Input Voltage Range		2.6		6	V
Input UVLO	Rising, Hysteresis=100mV		2.5		V
Input Supply Current	$V_{FB} = 0.65V$		38		μA
Input Shutdown Current				1	μA
FB Feedback Voltage	$V_{IN} = 2.5$ to 5V	0.588	0.6	0.612	V
FB Input Current			0.01		μA
Output Voltage Range		0.6		V_{IN}	V
Load Regulation			0.1		%
Line Regulation	$V_{IN} = 2.7$ to 5.5V		0.04		%/V
Switching Frequency			1.5		MHz
NMOS Switch On Resistance	$I_{SW} = 200mA$		280		$m\Omega$
PMOS Switch On Resistance	$I_{SW} = 200mA$		200		$m\Omega$
PMOS Switch Current Limit		1.5			A
SW Leakage Current	$V_{OUT} = 5.5V, V_{SW} = 0$ or 5.5V, EN= GND			10	μA
EN Input Current				1	μA
EN Input Low Voltage		0.4			V
EN Input High Voltage				1.5	V

PIN DESCRIPTION

PIN #	NAME	DESCRIPTION
1	EN	Enable pin for the IC. Drive this pin to high to enable the part, low to disable.
2	GND	Ground
3	SW	Inductor Connection. Connect an inductor Between SW and the regulator output.
4	IN	Supply Voltage. Bypass with a 10 μF ceramic capacitor to GND
5	FB	Feedback Input. Connect an external resistor divider from the output to FB and GND to set the output to a voltage between 0.6V and V_{IN}

TYPICAL CHARACTERISTICS

(Typical values are at TA = 25°C unless otherwise specified.)

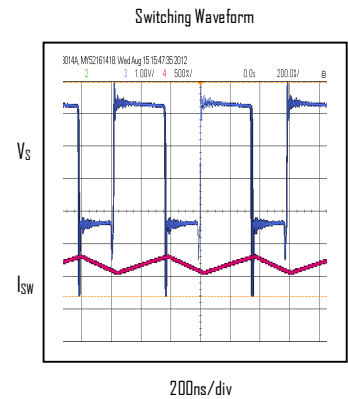
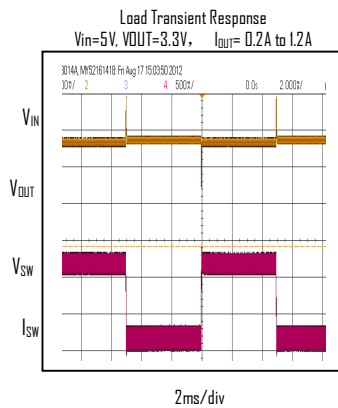
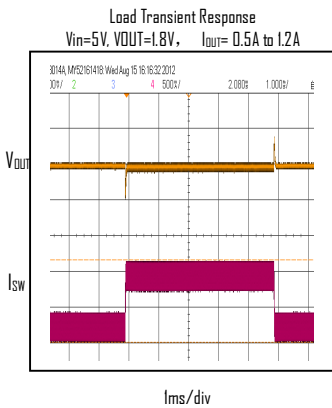
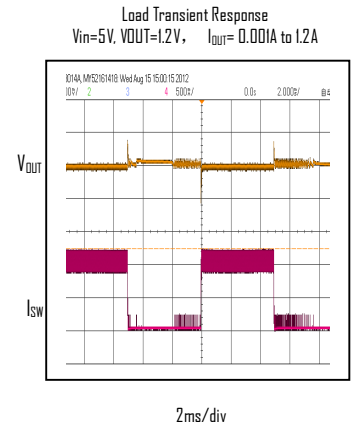
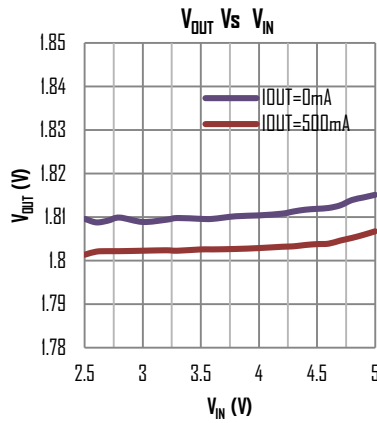
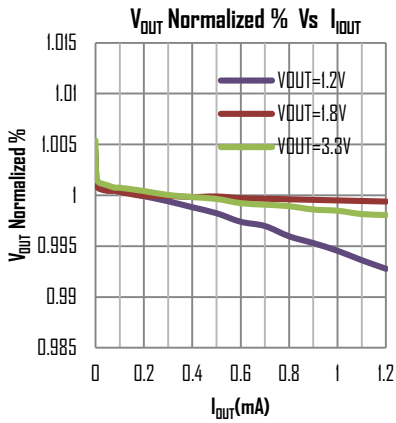
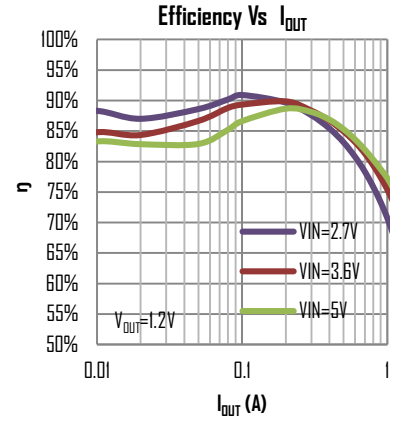
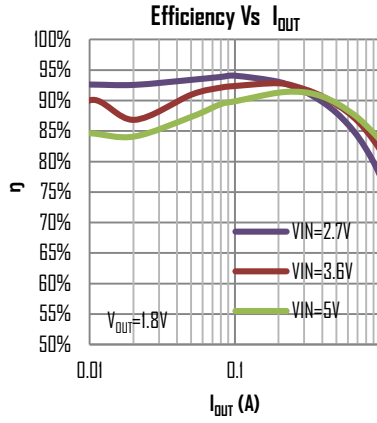
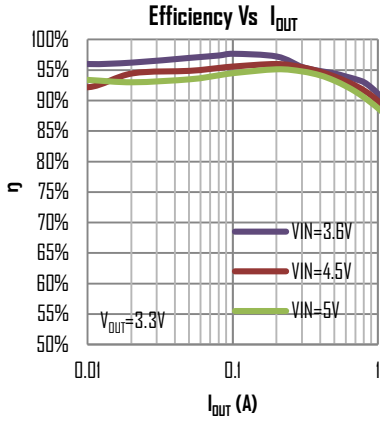

TYPICAL CHARACTERISTICS

(Typical values are at $T_A = 25^{\circ}\text{C}$ unless otherwise specified.)

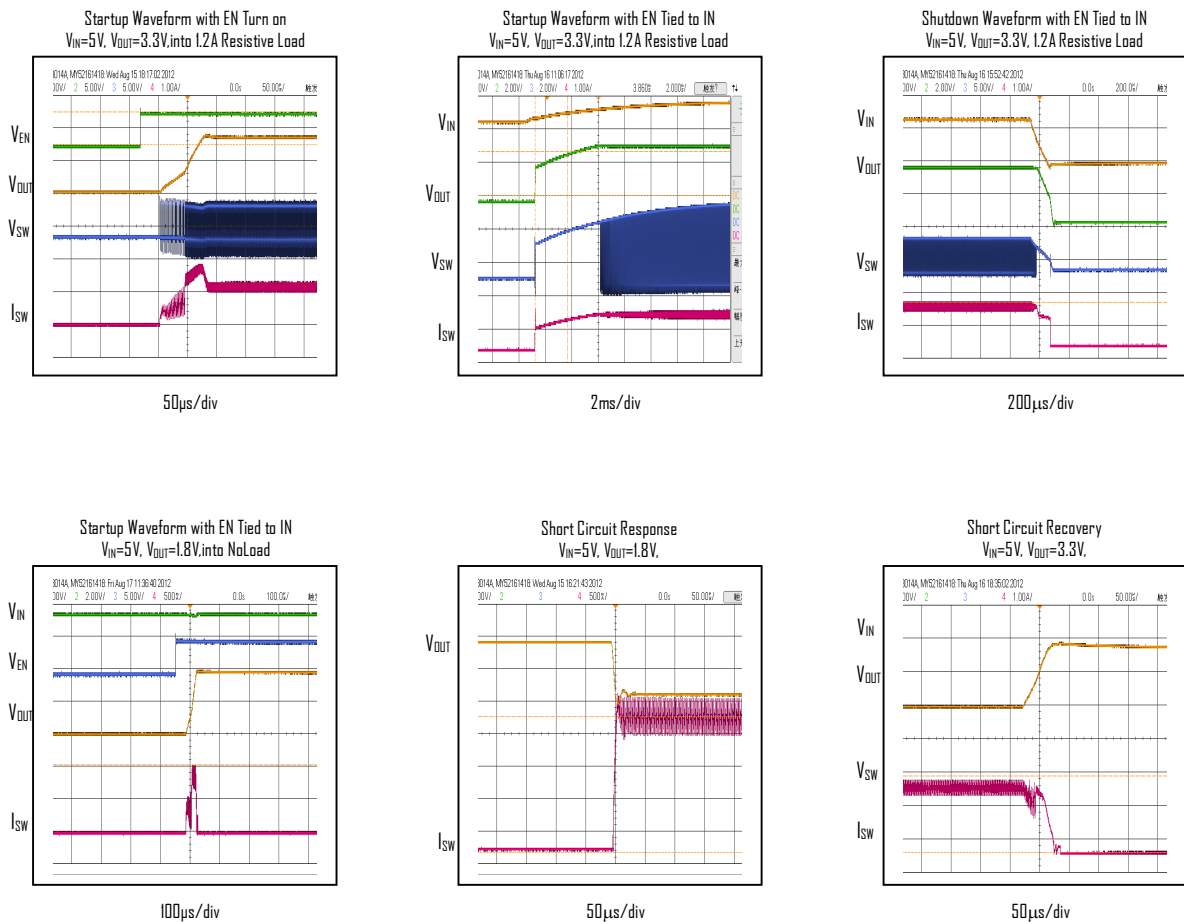

FUNCTION DESCRIPTION

The ETA3406 high efficiency switching regulator is a small, simple, DC-to-DC step-down converter capable of delivering up to 1.2A of output current. The device operates in pulse-width modulation (PWM) at 1.5MHz from a 2.6V to 5.5V input voltage and provides an output voltage from 0.6V to V_{IN} , making the ETA3406 ideal for on-board post-regulation applications. An internal synchronous rectifier improves efficiency and eliminates the typical Schottky free-wheeling diode. Using the on resistance of the internal high-side MOSFET to sense switching currents eliminates current-sense resistors, further improving efficiency and cost.

Loop Operation

ETA3406 uses a PWM current-mode control scheme. An open-loop comparator compares the integrated voltage-feedback signal against the sum of the amplified current-sense signal and the slope compensation ramp. At each rising edge of the internal clock, the internal high-side MOSFET turns on until the PWM comparator terminates the on cycle. During this on-time, current ramps up through the inductor, sourcing current to the output and storing energy in the inductor. The current mode feedback system regulates the peak inductor current as a function of the output voltage error signal. During the off cycle, the internal high-side P-channel MOSFET turns off, and the internal low-side N-channel MOSFET turns on. The inductor releases the stored energy as its current ramps down while still providing current to the output.

Current Sense

An internal current-sense amplifier senses the current through the high-side MOSFET during on time and produces a proportional current signal, which is used to sum with the slope compensation signal. The summed signal then is compared with the error amplifier output by the PWM comparator to terminate the on cycle.

Current Limit

There is a cycle-by-cycle current limit on the high-side MOSFET. When the current flowing out of SW exceeds this limit, the high-side MOSFET turns off and the synchronous rectifier turns on. ETA3406 utilizes a frequency fold-back mode to prevent overheating during short-circuit output conditions. The device enters frequency fold-back mode when the FB voltage drops below 200mV, limiting the current to I_{PEAK} and reducing power dissipation. Normal operation resumes upon removal of the short-circuit condition.

Soft-start

ETA3406 has a internal soft-start circuitry to reduce supply inrush current during startup conditions. When the device exits under-voltage lockout (UVLO), shutdown mode, or restarts following a thermal-overload event, the I soft-start circuitry slowly ramps up current available at SW.

UVLO and Thermal Shutdown

If IN drops below 2.5V, the UVLO circuit inhibits switching. Once IN rises above 2.6V, the UVLO clears, and the soft-start sequence activates. Thermal-overload protection limits total power dissipation in the device. When the junction temperature exceeds $T_J = +160^{\circ}\text{C}$, a thermal sensor forces the device into shutdown, allowing the die to cool. The thermal sensor turns the device on again after the junction temperature cools by 15°C , resulting in a pulsed output during continuous overload conditions. Following a thermal-shutdown condition, the soft-start sequence begins.

Design Procedure

Setting Output Voltages

Output voltages are set by external resistors. The FB_{_} threshold is 0.6V.

$$R_{TOP} = R_{BOTTOM} \times [(V_{OUT} / 0.6) - 1]$$

Input Capacitor Selection

The input capacitor in a DC-to-DC converter reduces current peaks drawn from the battery or other input power source and reduces switching noise in the controller. The impedance of the input capacitor at the switching frequency should be less than that of the input source so high-frequency switching currents do not pass through the input source. The output capacitor keeps output ripple small and ensures control-loop stability. The output capacitor must also have low impedance at the switching frequency. Ceramic, polymer, and tantalum capacitors are suitable, with ceramic exhibiting the lowest ESR and high-frequency impedance.

Output ripple with a ceramic output capacitor is approximately as follows:

$$V_{RIPPLE} = I_{L(PEAK)} [1 / (2\pi \times f_{OSC} \times C_{OUT})]$$

If the capacitor has significant ESR, the output ripple component due to capacitor ESR is as follows:

$$V_{RIPPLE(ESR)} = I_{L(PEAK)} \times ESR$$

Output Capacitor and Inductor Selection

If much smaller values are used, inductor current rises, and a larger output capacitance may be required to suppress output ripple. Larger values than L_{IDEAL} can be used to obtain higher output current, but typically with larger inductor size.

BLOCK DIAGRAM

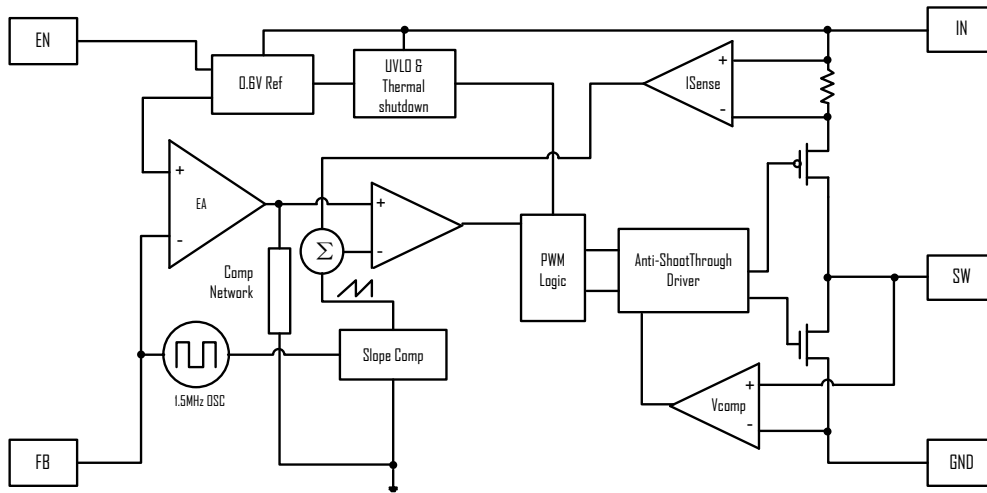

PACKAGE OUTLINE

SOT23-5 PACKAGE OUTLINE AND DIMENSIONS

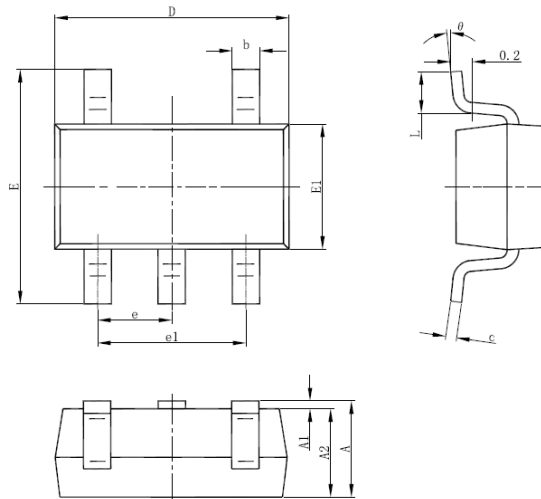

Symbol	Dimensions In Millimeters		Dimensions In Inches	
	Min.	Max.	Min.	Max.
A	1.050	1.250	0.041	0.049
A1	0.000	0.100	0.000	0.004
A2	1.050	1.150	0.041	0.045
b	0.300	0.500	0.012	0.020
c	0.100	0.200	0.004	0.008
D	2.820	3.020	0.111	0.119
E1	1.500	1.700	0.059	0.067
E	2.650	2.950	0.104	0.116
e	0.950(BSC)		0.037(BSC)	
e1	1.800	2.000	0.071	0.079
L	0.300	0.600	0.012	0.024
θ	0°	8°	0°	8°

X-ON Electronics

Largest Supplier of Electrical and Electronic Components

Click to view similar products for [Isolated DC/DC Converters](#) category:

Click to view products by [etasolution](#) manufacturer:

Other Similar products are found below :

[PSL486-7LR](#) [Q48T30020-NBB0](#) [JAHW100Y1](#) [SPB05C-12](#) [SQ24S15033-PS0S](#) [CE-1003](#) [CE-1004](#) [MAU228](#) [J80-0041NL](#) [DFC15U48D15](#)
[XGS-1205](#) [06322](#) [SPB05B-15](#) [L-DA20](#) [DCG40-5G](#) [XKS-2405](#) [DPA423R](#) [vi-m13-cw-03](#) [VI-L53-CV](#) [24IBX15-50-0ZG](#) [HZZ01204-G](#)
[SPU02L-09](#) [SPU02M-09](#) [SPU02N-09](#) [QUINT4-BUFFER/24DC/40](#) [QUINT4-CAP/24DC/5/4KJ](#) [73-551-5039I](#) [DFC15U48D15G](#) [SEN-6471-](#)
[1EM](#) [AHV2815DF/HBB](#) [MI-LC21-IX](#) [PAH-48/8.5-D48NB1-C](#) [BM3020-7A](#) [QRS2050P025K00](#) [CM2320-9EG](#) [SKMW15F-05](#)
[V300A28H400BF3](#) [TEN 15-1223](#) [TEQ 100-2418WIR](#) [TEQ 160-7218WIR](#) [R05C05TE05S-R](#) [HQA2W085W033V-N07-S](#) [AM1SS-2405SJZ](#)
[AM2DS-1224SJZ](#) [AM2DS-2405DJZ](#) [AM10SBO-4824SNZ-B](#) [AM15E-2405S-NZ](#) [AM2DS-1212SJZ](#) [AM30SBO-4805SNZ-B](#)
[LT8301ES5#WTRPBF](#)