

## 6V/3.5A, Fast Response, Adaptive COT Step-Down Converter in Tiny DFN2x2

### DESCRIPTION

ETA3451 belongs to a new breed of high frequency synchronous Step-Down converter that combines the advantages of voltage mode control and Constant-On-Time control. Its adaptive Constant-On-Time control dynamically changes switch on time to achieve a constant switching frequency. It does not have the minimum on-time constrain normally a fixed-frequency current mode Step-down requires, allowing it to go down to very low duty ratio without affecting loop stability. The voltage mode nature of ETA3451 also provides a more superior load transient response and a seamless transition from PFM to PWM modes. ETA3451 is capable of supplying output with current up to 3.5A at 1.2V output. All these features make ETA3451 an excellent choice for ARM based CPU power supply.

ETA3451 is in a tiny DFN2x2-8 package.

### FEATURES

- ◆ Adaptive COT control
- ◆ Up to 95% Efficiency
- ◆ Up to 91% Efficiency for low output voltage
- ◆ Up to 3.5A Max Output current
- ◆ Feedback voltage 0.45V
- ◆ Excellent load transient response
- ◆ DFN2X2-8 Package

### APPLICATIONS

- ◆ ARM based CPUs
- ◆ Tablet, MID
- ◆ Smart Phone
- ◆ Smart Set-Top Box, OTT

### ORDERING INFORMATION

PART	PACKAGE	TOP MARK
ETA3451D2I	DFN2x2-8	FBYW FB: Product Code YW: Date Code

### TYPICAL APPLICATION

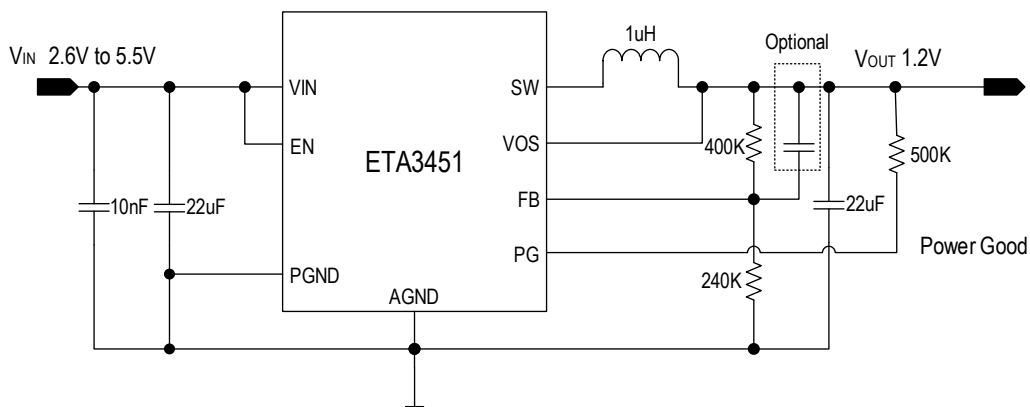

Typical Application Circuit of 1.2V Output

## PIN CONFIGURATION

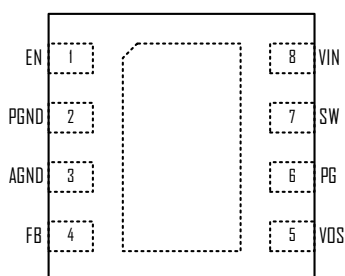

## ABSOLUTE MAXIMUM RATINGS

(Note: Exceeding these limits may damage the device. Exposure to absolute maximum rating conditions for long periods may affect device reliability.)

VIN Voltage .....	-0.3V to 6.0V
All Other Pin Voltage .....	VIN-0.3V to VIN+0.3V
SW to ground current.....	Internally limited
Operating Temperature Range .....	-40°C to 85°C
Storage Temperature Range .....	-55°C to 150°C
Thermal Resistance $\theta_{JA}$	
DFN2x2-8.....	75 °C/W

## ELECTRICAL CHARACTERISTICS

(VIN = 3.6V, unless otherwise specified. Typical values are at TA = 25°C.)

PARAMETER	CONDITIONS	MIN	TYP	MAX	UNITS
Input Voltage Range		2.6		5.5	V
Input UVLO	Rising, Hysteresis=250mV		2.15		V
Input OVP	Rising, Hysteresis=200mV		6.25		V
Input Supply Current	V <sub>FB</sub> =0.5V, Device Not Switching		50		μA
Input Shutdown Current	EN=GND		0.1	1	μA
FB Feedback Voltage		0.441	0.45	0.459	V
FB Input Current			0.01		μA
Output Voltage Range		0.45		V <sub>IN</sub>	V
Load Regulation			0.2		%/A
Line Regulation	V <sub>IN</sub> =3V to 4V		0.1		%/V
Switching Frequency			1.5		MHz
PMOS Switch On Resistance	I <sub>SW</sub> =200mA		120		mΩ
NMOS Switch On Resistance	I <sub>SW</sub> =200mA		60		mΩ
PMOS Switch Current Limit	V <sub>IN</sub> =5V		4.5		A
SW Leakage Current	V <sub>IN</sub> =5V, V <sub>SW</sub> =0 or 5V,EN=GND			10	μA
EN Input Current				1	μA
EN Input Low Voltage				0.4	V
EN Input High Voltage		1.5			V
Power Good Threshold	Rising, Hysteresis=2.5%		90		%
Power Good Low level	I <sub>(SINK)</sub> =1mA			0.4	V
Thermal Shutdown	Rising, Hysteresis =30°C		155		°C

## PIN DESCRIPTION

PIN #	NAME	DESCRIPTION
1	EN	Enable pin for the IC. Drive this pin to high to enable the part, low to disable.
2	PGND	Power Ground. The ground of internal power NMOS. Bypass with a 22 $\mu$ F ceramic capacitor to VIN
3	AGND	Analog Ground. To keep this ground free from noise by connecting a 10nF ceramic capacitor to VIN. Do not short this pin to PGND directly in PCB, but through a PCB trace to connect the 2 GND together.
4	FB	Feedback Input. Connect an external resistor divider from the output to FB and GND to set the output to a voltage between 0.45V and VIN
5	VOS	Output voltage sense pin, to be connected to the output node of regulator.
6	PG	Power Good Pin. This pin is high impedance if the output voltage is within regulation. This pin is pulled low if the output is below its nominal value. The pull up resistor cannot be connected to any voltage higher than the input voltage of the device.
7	SW	Inductor Connection. Connect an 1 $\mu$ H inductor Between SW and the regulator output.
8	VIN	Supply Voltage. Bypass with a 22 $\mu$ F ceramic capacitor to PGND and 10nF to AGND.

## TYPICAL CHARACTERISTICS

(Typical values are at  $T_A = 25^\circ\text{C}$  unless otherwise specified.)

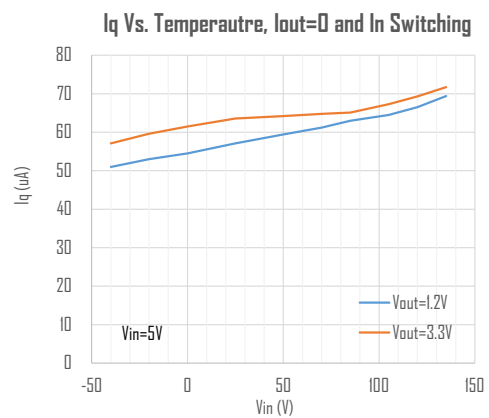
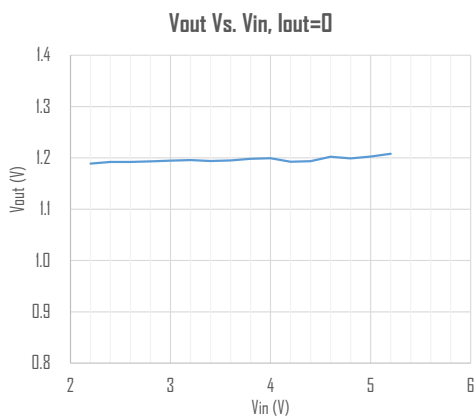
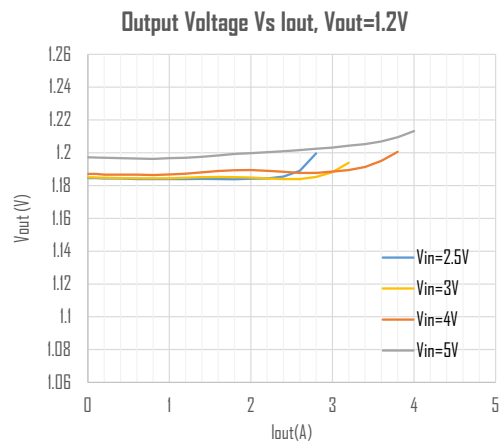
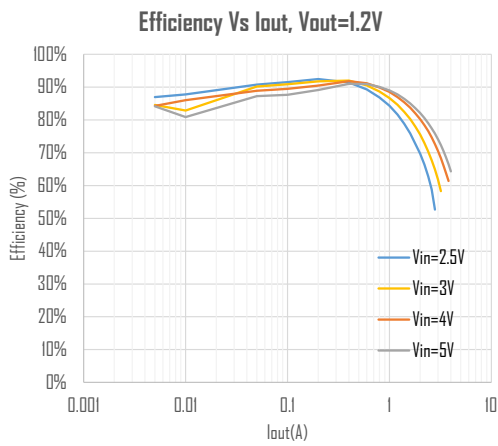
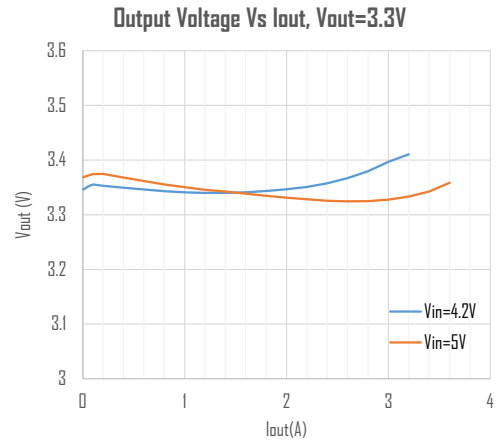
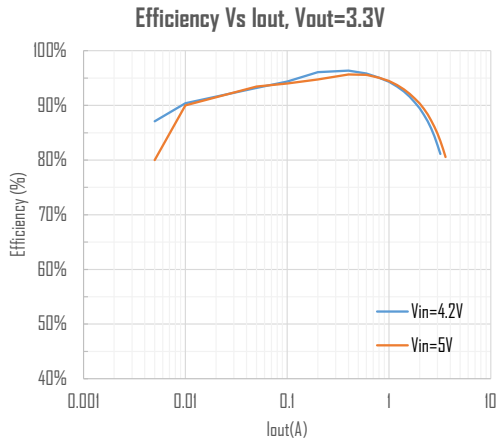

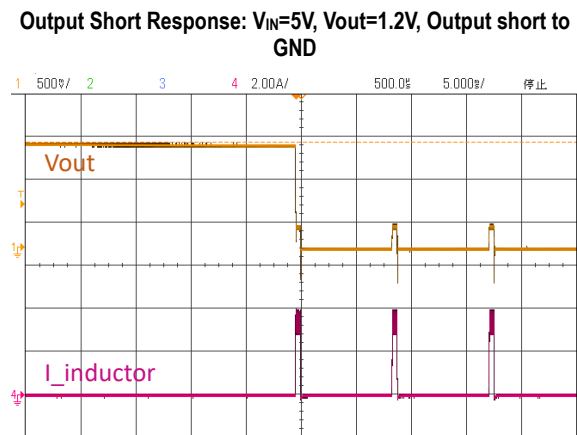
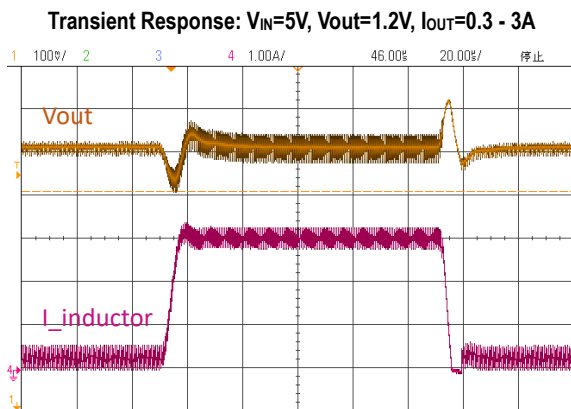
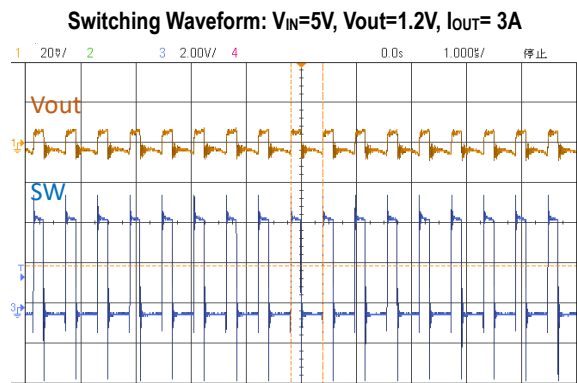
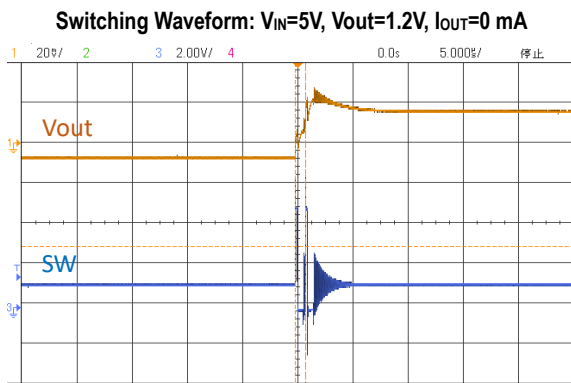
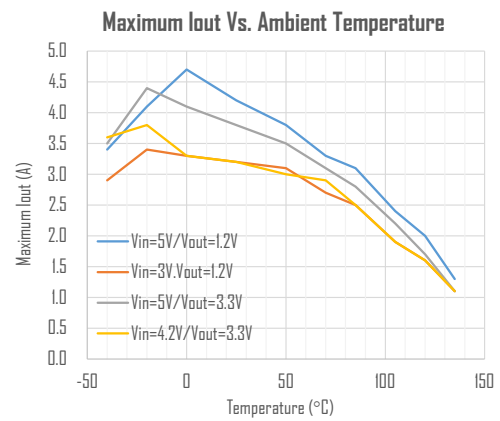
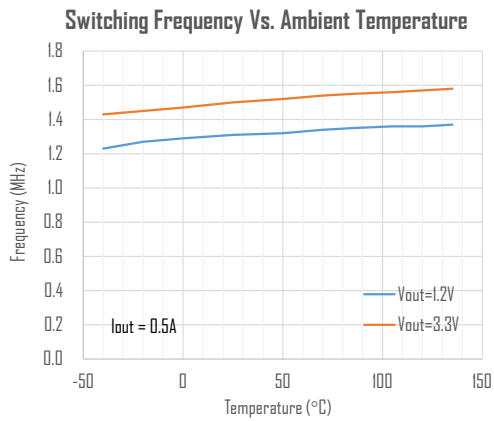

## FUNCTIONAL DESCRIPTIONS

ETA3451 belongs to a new breed of high frequency synchronous Step-Down converter that combines the advantages of voltage mode control and Constant On time control. Its adaptive Constant-On-Time control dynamically changes switch on time to achieve a constant switching frequency. It does not have the minimum on-time constrain normally a fixed-frequency current mode Step-down requires, allowing it to go down to very low duty ratios without affecting loop stability. The voltage mode nature of ETA3451 also provides a more superior load transient response as well as a seamless transition from PFM to PWM modes. It can also operate up to 100% duty. It has a cycle by cycle current limit and a hiccup mode that protects against dead-short condition. It includes soft-start, UVLO and thermal shutdown protection.

### *Adaptive Constant On-Time Control*

ETA3451 uses an adaptive Constant-On-Time control scheme that the ON time is dynamically adjusted according to VIN and VOUT so to achieve a nearly constant switching frequency. This control scheme provides simpler compensation and superior transient response over traditional constant frequency current mode control, while still maintaining the advantage of switching at a constant frequency at about 1.5MHz. It also provides a seamless transition from PFM to PWM that normally a constant frequency current mode control scheme is hard to achieve. Further mode, because it is a COT control scheme, the system can achieve high step-down ratio at ease, because lower constrain on the minimum on- time requirement existing in constant frequency scheme.

### *100% Duty operation*

ETA3451 can operate at 100% duty cycle under dropout condition for high efficiency purpose.

### *Current Limit and Short-Circuit protection*

ETA3451 employs a cycle-by-cycle peak current limit and it also has a hiccup mode that protects the circuit during dead-short condition. When the dead-short condition is removed, the IC goes back to normal operation.

### *Soft-start*

ETA3451 has an internal soft-start circuitry to reduce supply inrush current during startup conditions. When the device exits under-voltage lockout (UVLO), shutdown mode, or restarts following a thermal-overload event, the I soft-start circuitry slowly ramps up current available at SW.

### *UVLO and Thermal Shutdown*

If IN drops below UVLO threshold, the UVLO circuit inhibits switching. Once IN rises above ULVO threshold, the UVLO clears, and the soft-start sequence activates. Thermal-overload protection limits total power dissipation in the device. When the junction temperature exceeds  $T_J = +155^{\circ}\text{C}$ , a thermal sensor forces the device into shutdown, allowing the die to cool. The thermal sensor turns the device on again after the junction temperature cools by  $30^{\circ}\text{C}$ , resulting in a pulsed output during continuous overload conditions. Following a thermal-shutdown condition, the soft-start sequence begins.

## Design Procedure

### Setting Output Voltages

Output voltages are set by external resistors. The FB threshold is 0.45V.

$$R_{TOP} = R_{BOTTOM} \times [(V_{OUT} / 0.45) - 1]$$

### Inductor Selection

The peak-to-peak ripple is limited to 30% of the maximum output current. This places the peak current far enough from the minimum overcurrent trip level to ensure reliable operation while providing enough current ripples for the current mode converter to operate stably.  $L_{IDEAL} = (V_{IN(MAX)} - V_{OUT}) / I_{RIPPLE} * D_{MIN} * (1 / F_{OSC})$

### Output Capacitor Selection

The output capacitor keeps output ripple small and ensures control-loop stability. The output capacitor must also have low impedance at the switching frequency. Ceramic, or a MLCC capacitors are suitable, with ceramic exhibiting the lowest ESR and high-frequency impedance. Output ripple with a ceramic output capacitor is approximately as follows:

$$V_{RIPPLE} = I_{L(PEAK)} [1 / (2\pi \times f_{OSC} \times C_{OUT})]$$

If the capacitor has significant ESR, the output ripple component due to capacitor ESR is as follows:

$$V_{RIPPLE(ESR)} = I_{L(PEAK)} \times ESR$$

### Input Capacitor Selection

The input capacitor in a DC-to-DC converter reduces current peaks drawn from the battery or other input power source and reduces switching noise in the controller. The impedance of the input capacitor at the switching frequency should be less than that of the input source so high-frequency switching currents do not pass through the input source. The output capacitor keeps output ripple small and ensures control-loop stability.

## PCB LAYOUT

The ETA3451 employs a sophisticated control scheme to achieve the fast response and other superior performances. So the PCB layout is recommended to strictly follow the proposed way shown below. The Cin (22uF) and Cout (22uF or 10uF x 2) are always to be placed closest to ETA3451. The Cin1 (10nF) is also require to be connected to AGND (not PGND) to filter out the switching noise. Please don't short Pin2 (PGND) and Pin3 (AGND) directly, but through a PCB trace, as what's shown below.

Please contact ETA engineers for confirmation if one needs to change the PCB layout.

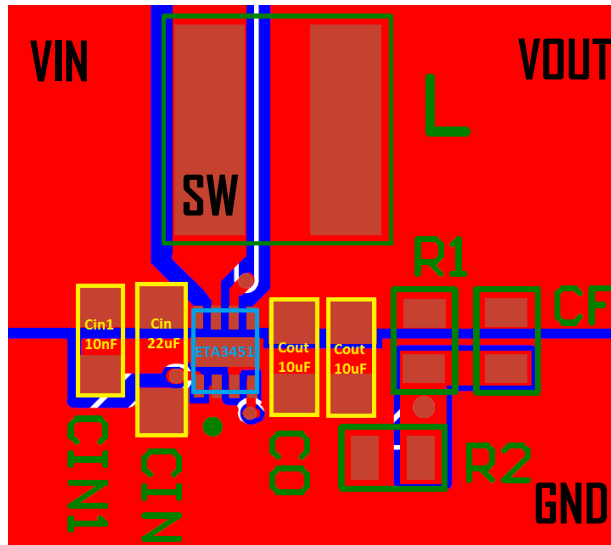

## BLOCK DIAGRAM

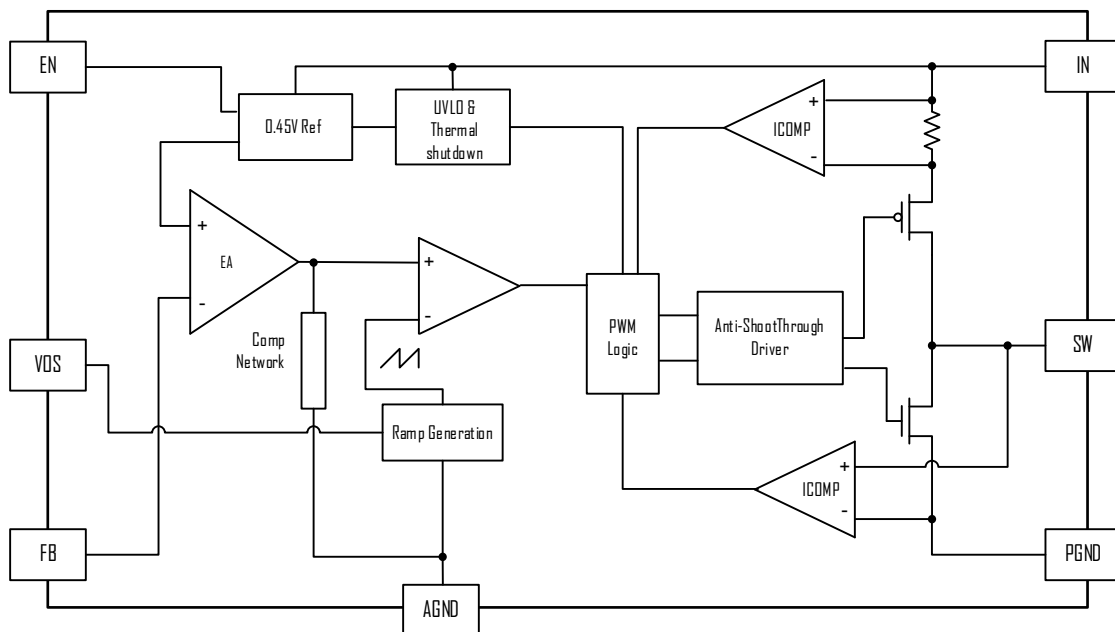



## PACKAGE OUTLINE

Package: DFN2x2-8

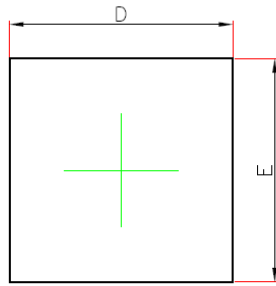

TOP VIEW

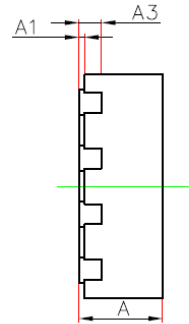

SIDE VIEW

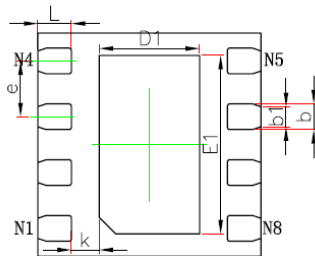

BOTTOM VIEW

Symbol	Dimensions In Millimeters		Dimensions In Inches	
	Min.	Max.	Min.	Max.
A	0.700	0.800	0.028	0.031
A1	0.000	0.050	0.000	0.002
A3	0.203REF.		0.008REF.	
D	1.900	2.100	0.075	0.083
E	1.900	2.100	0.075	0.083
D1	0.800	1.050	0.031	0.041
E1	1.400	1.700	0.055	0.067
k	0.250 REF.		0.010REF.	
b	0.200	0.300	0.008	0.012
b1	0.180REF.		0.007REF.	
e	0.500BSC.		0.020BSC.	
L	0.224	0.376	0.009	0.015

## X-ON Electronics

Largest Supplier of Electrical and Electronic Components

*Click to view similar products for [Isolated DC/DC Converters](#) category:*

*Click to view products by [etasolution](#) manufacturer:*

Other Similar products are found below :

[PSL486-7LR](#) [Q48T30020-NBB0](#) [JAHW100Y1](#) [SPB05C-12](#) [SQ24S15033-PS0S](#) [CE-1003](#) [CE-1004](#) [MAU228](#) [J80-0041NL](#) [DFC15U48D15](#)  
[XGS-1205](#) [06322](#) [SPB05B-15](#) [L-DA20](#) [DCG40-5G](#) [XKS-2405](#) [DPA423R](#) [vi-m13-cw-03](#) [VI-L53-CV](#) [24IBX15-50-0ZG](#) [HZZ01204-G](#)  
[SPU02L-09](#) [SPU02M-09](#) [SPU02N-09](#) [QUINT4-BUFFER/24DC/40](#) [QUINT4-CAP/24DC/5/4KJ](#) [73-551-5039I](#) [DFC15U48D15G](#) [SEN-6471-](#)  
[1EM](#) [AHV2815DF/HBB](#) [MI-LC21-IX](#) [PAH-48/8.5-D48NB1-C](#) [BM3020-7A](#) [QRS2050P025K00](#) [CM2320-9EG](#) [SKMW15F-05](#)  
[V300A28H400BF3](#) [TEN 15-1223](#) [TEQ 100-2418WIR](#) [TEQ 160-7218WIR](#) [R05C05TE05S-R](#) [HQA2W085W033V-N07-S](#) [AM1SS-2405SJZ](#)  
[AM2DS-1224SJZ](#) [AM2DS-2405DJZ](#) [AM10SBO-4824SNZ-B](#) [AM15E-2405S-NZ](#) [AM2DS-1212SJZ](#) [AM30SBO-4805SNZ-B](#)  
[LT8301ES5#WTRPBF](#)