

3A, 1MHz Synchronous Buck Converter with 7.3V OVP

DESCRIPTION

The ETA3499 is a high-efficiency, DC-to-DC step-down switching regulator, capable of delivering up to 3A of output current. The devices operate from an input voltage range of 2.4V to 7.3V and provide output voltages from 0.6V to V_{IN} , making the ETA3499 ideal for low voltage power conversions. Running at a fixed frequency of 1MHz allows the use of small inductance value and low DCR inductors, thereby achieving higher efficiencies. Other external components, such as ceramic input and output caps, can also be small due to higher switching frequency, while maintaining exceptional low noise output voltages. Internal soft-start control circuitry reduces inrush current. Short-circuit and thermal-overload protection improves design reliability. ETA3499 is housed in a tiny SOT23-6L package

FEATURES

- ◆ Wide Input Voltage Range: 2.4 – 7.3V
- ◆ Standby Current 42uA ($V_{out}=1.2V$, $I_{out}=0A$)
- ◆ Up to 96% Efficiency
- ◆ Up to 3A Max Output Current
- ◆ 1MHz Frequency
- ◆ Light Load operation
- ◆ Internal Compensation
- ◆ Tiny SOT23-6L Package

APPLICATIONS

- ◆ Set-Top-Box
- ◆ IP camera
- ◆ Telecom Devices

TYPICAL APPLICATION

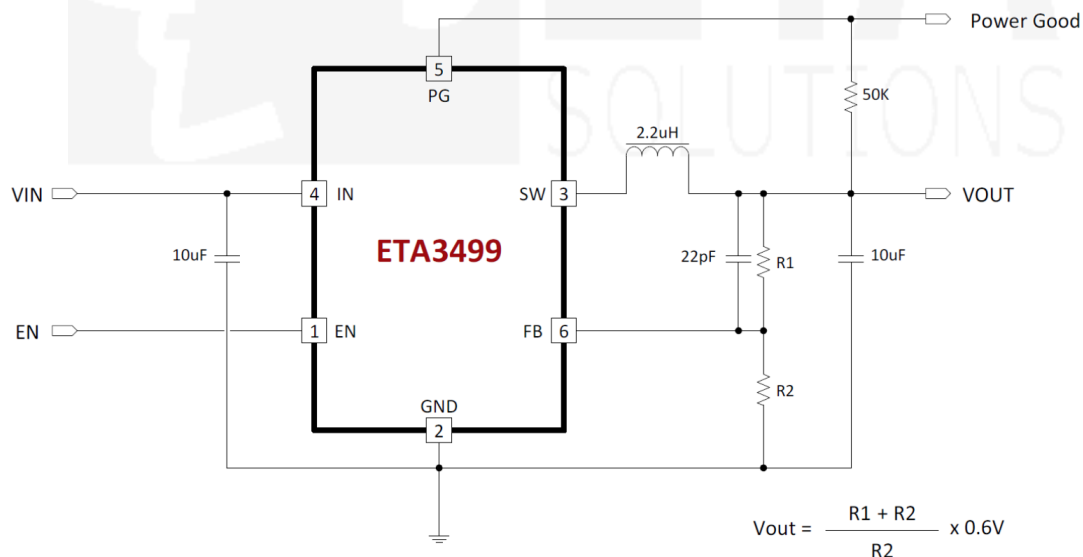

ORDERING INFORMATION

PART No.
ETA3499S2G

PACKAGE
SOT23-6

TOP MARK
BHYW

Pcs/Reel
3000

PIN CONFIGURATION

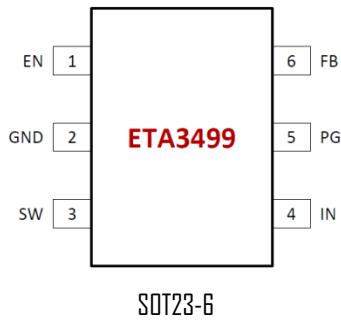

ABSOLUTE MAXIMUM RATINGS

(Note: Exceeding these limits may damage the device. Exposure to absolute maximum rating conditions for long periods may affect device reliability.)

IN, FB, EN Voltage.....	-0.3V to 9V
SW Voltage.....	-0.3V(-2V for <10nS) to 9V
SW to ground current	4A
Operating Temperature Range	-40°C to 85°C
Storage Temperature Range	-55°C to 150°C
Thermal Resistance	θ_{JC} θ_{JA}
SOT23-6L.....	110.....220 °C/W
Lead Temperature (Soldering, 10ssec)	260°C
ESD HBM (Human Body Mode)	2KV

ELECTRICAL CHARACTERISTICS

(V_{IN} = 5V, unless otherwise specified. Typical values are at T_A = 25°C.)

PARAMETER	CONDITIONS	MIN	TYP	MAX	UNITS
Input Voltage Range		2.4		7.3	V
Input UVLO	Rising, Hysteresis=490mV	2.2	2.4	2.6	V
Input Supply Current	$V_{FB}=0.65V$		42	86	μA
Input Shutdown Current				1	μA
FB Feedback Voltage	$V_{IN}=3.6V$	0.588	0.6	0.612	V
FB Input Current				1	μA
Output Voltage Range		0.6		V_{IN}	V
Load Regulation	$I_{load}=0.2A$ to 1A		0.1		%/A
Line Regulation	$V_{IN}=2.7$ to 5.5V @ $I_{load}=1A$		0.06		%/V
Switching Frequency			1		MHz
NMOS Switch On Resistance	$I_{SW}=200mA$		140		$m\Omega$
PMOS Switch On Resistance	$I_{SW}=200mA$		70		$m\Omega$
PMOS Switch Current Limit			4		A
SW Leakage Current	$V_{IN}=5.5V, V_{SW}=0$ or 5.5V, EN= GND			10	μA
EN Input Current				1	μA
EN Input Low Voltage				0.4	V
EN Input High Voltage		1.5			V
Power Good Threshold	Rising, Hysteresis=6%		90		%
Power Good Low level	$I(SINK)=1mA$			0.4	V
Thermal Shutdown	Rising, Hysteresis =30°C		160		°C

PIN DESCRIPTION

PIN #	NAME	DESCRIPTION
1	EN	Enable pin for the IC. Drive this pin high to enable the part, low to disable.
2	GND	Ground
3	SW	Inductor Connection. Connect an inductor Between SW and the regulator output.
4	IN	Supply Voltage. Bypass with a 10 μ F ceramic capacitor to GND
5	PG	Power Good Pin. This pin is high impedance if the output voltage is within regulation. This pin is pulled low if the output is below its nominal value. The pull up resistor cannot be connected to any voltage higher than the input voltage of the device.
6	FB	Feedback Input. Connect an external resistor divider from the output to FB and GND to set the output to a voltage between 0.6V and VIN

TYPICAL CHARACTERISTICS

(Typical values are at $T_A = 25^\circ\text{C}$ unless otherwise specified.)

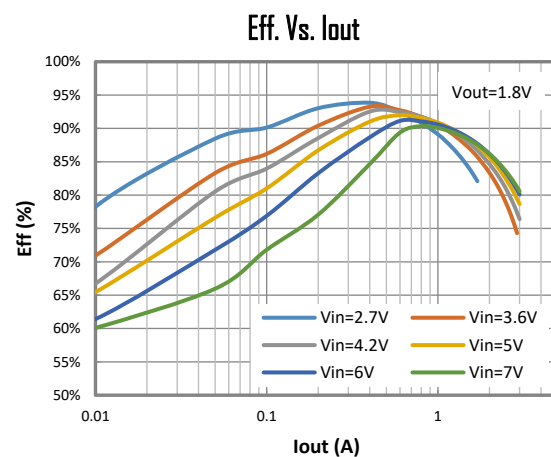
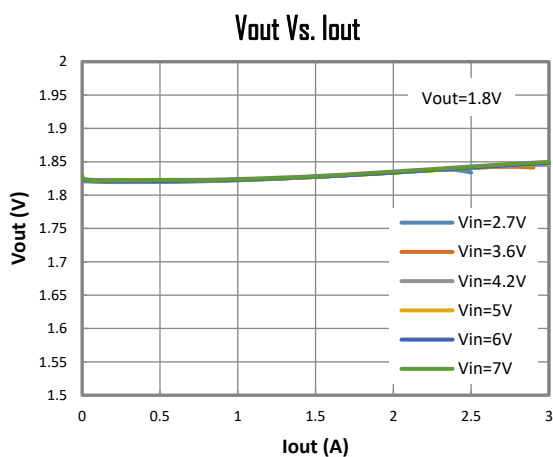
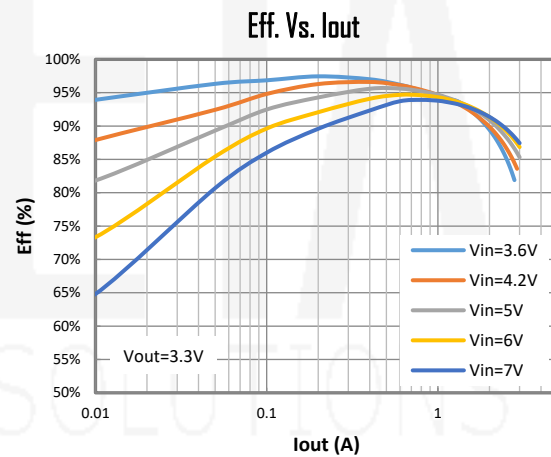
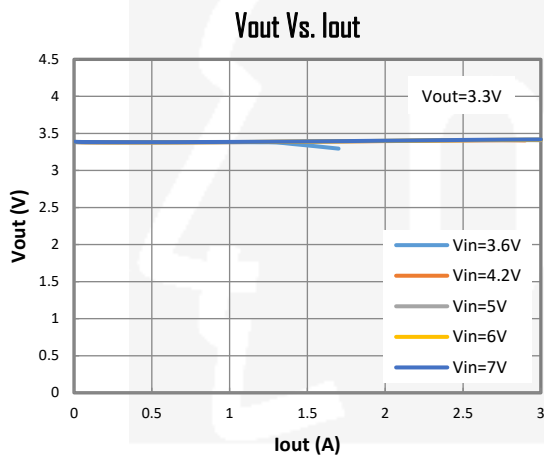

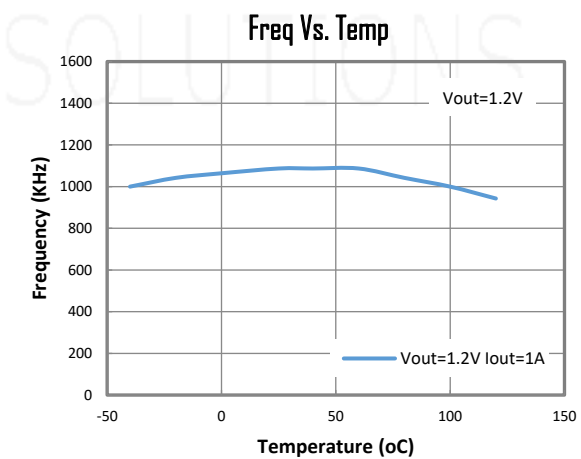
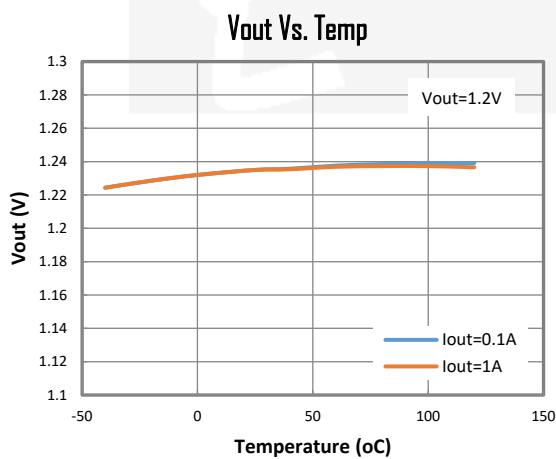
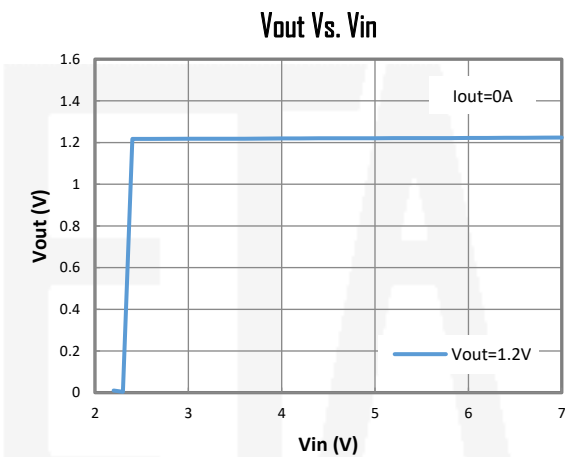
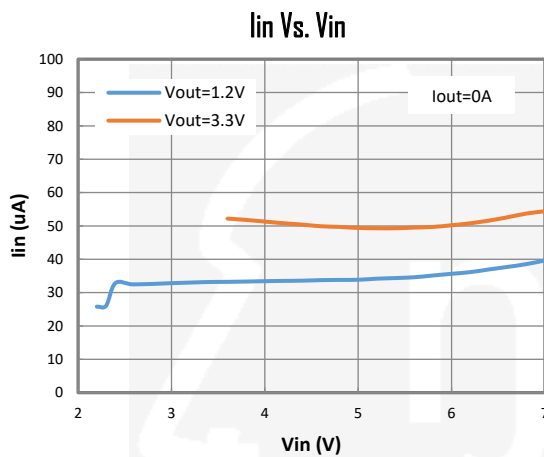
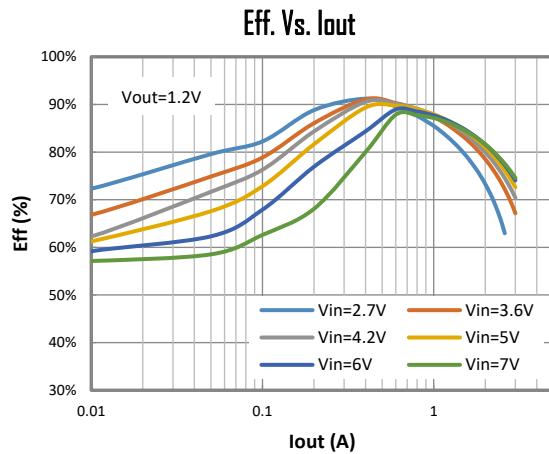
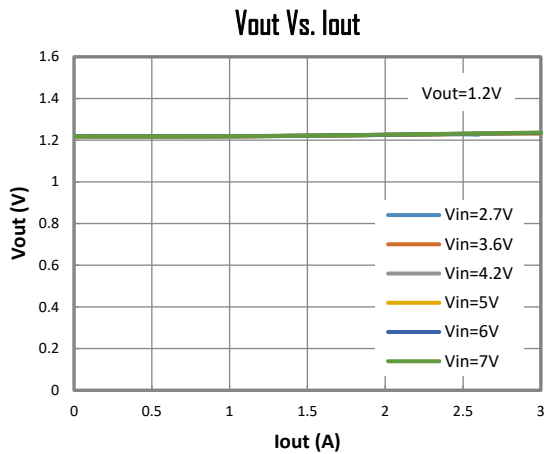

APPLICATION INFORMATION

FUNCTION DESCRIPTION

The ETA3499 high efficiency switching regulator is a small, simple, DC-to-DC step-down converter capable of delivering up to 3A of output current. The device operates in pulse-width modulation (PWM) at 1MHz from a 2.4V to 7.3V input voltage and

provides an output voltage from 0.6V to V_{IN} , making the ETA3499 ideal for on-board post-regulation applications. An internal synchronous rectifier improves efficiency and eliminates the typical Schottky free-wheeling diode. Using the on resistance of the internal high-side MOSFET to sense switching currents eliminates current-sense resistors, further improving efficiency and cost.

Loop Operation

ETA3499 uses a PWM current-mode control scheme. An open-loop comparator compares the integrated voltage-feedback signal against the sum of the amplified current-sense signal and the slope compensation ramp. At each rising edge of the internal clock, the internal high-side MOSFET turns on until the PWM comparator terminates the on cycle. During this on-time, current ramps up through the inductor, sourcing current to the output and storing energy in the inductor. The current mode feedback system regulates the peak inductor current as a function of the output voltage error signal. During the off cycle, the internal high-side P-channel MOSFET turns off, and the internal low-side N-channel MOSFET turns on. The inductor releases the stored energy as its current ramps down while still providing current to the output.

Current Sense

An internal current-sense amplifier senses the current through the high-side MOSFET during on time and produces a proportional current signal, which is used to sum with the slope compensation signal. The summed signal then is compared with the error amplifier output by the PWM comparator to terminate the on cycle.

Current Limit

There is a cycle-by-cycle current limit on the high-side MOSFET. When the current flowing out of SW exceeds this limit, the high-side MOSFET turns off and the synchronous rectifier turns on. ETA3499 utilizes a frequency fold-back mode to prevent overheating during short-circuit output conditions. The device enters frequency fold-back mode when the FB voltage drops below 200mV, limiting the current to I_{PEAK} and reducing power dissipation. Normal operation resumes upon removal of the short-circuit condition.

Soft-start

ETA3499 has an internal soft-start circuitry to reduce supply inrush current during startup conditions. When the device exits under-voltage lockout (UVLO), shutdown mode, or restarts following a thermal-overload event, the soft-start circuitry slowly ramps up current available at SW.

UVLO and Thermal Shutdown

If I_N drops below 2.2V, the UVLO circuit inhibits switching. Once I_N rises above 2.4V, the UVLO clears, and the soft-start sequence activates. Thermal-overload protection limits total power dissipation in the device. When the junction temperature exceeds $T_J = +160^\circ\text{C}$, a thermal sensor forces the device into shutdown, allowing the die to cool. The thermal sensor turns the device on again after the junction temperature cools by 30°C , resulting in a pulsed output during continuous overload conditions. Following a thermal-shutdown condition, the soft-start sequence begins.

PCB GUIDELINES

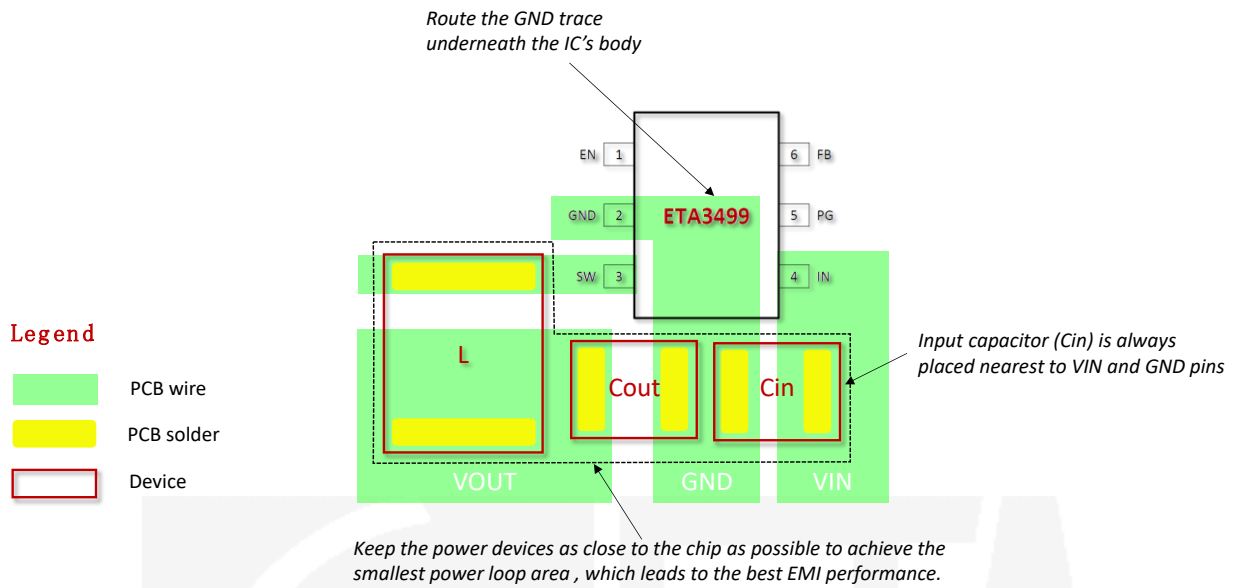

BLOCK DIAGRAM

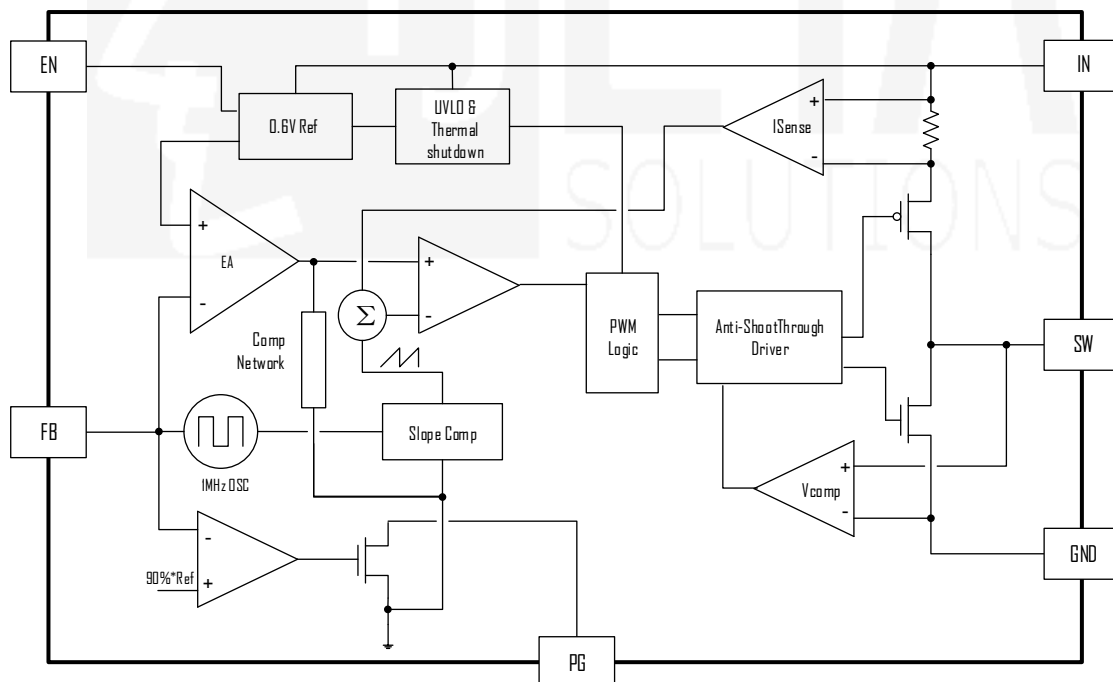

PACKAGE OUTLINE

Package: SOT23-6

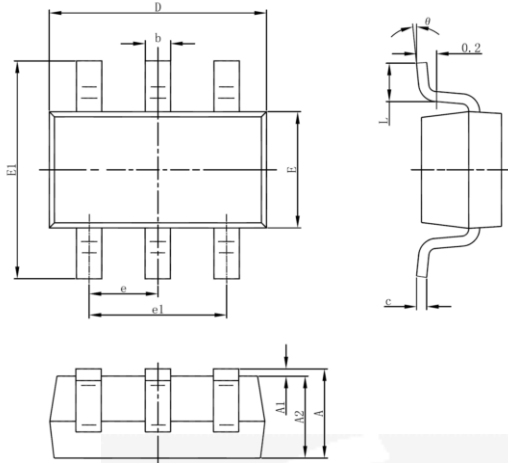

Symbol	Dimensions In Millimeters		Dimensions In Inches	
	Min	Max	Min	Max
A	1.050	1.250	0.041	0.049
A1	0.000	0.100	0.000	0.004
A2	1.050	1.150	0.041	0.045
b	0.300	0.500	0.012	0.020
c	0.100	0.200	0.004	0.008
D	2.820	3.020	0.111	0.119
E	1.500	1.700	0.059	0.067
E1	2.650	2.950	0.104	0.116
e	0.950(BSC)		0.037(BSC)	
e1	1.800	2.000	0.071	0.079
L	0.300	0.600	0.012	0.024
θ	0°	8°	0°	8°

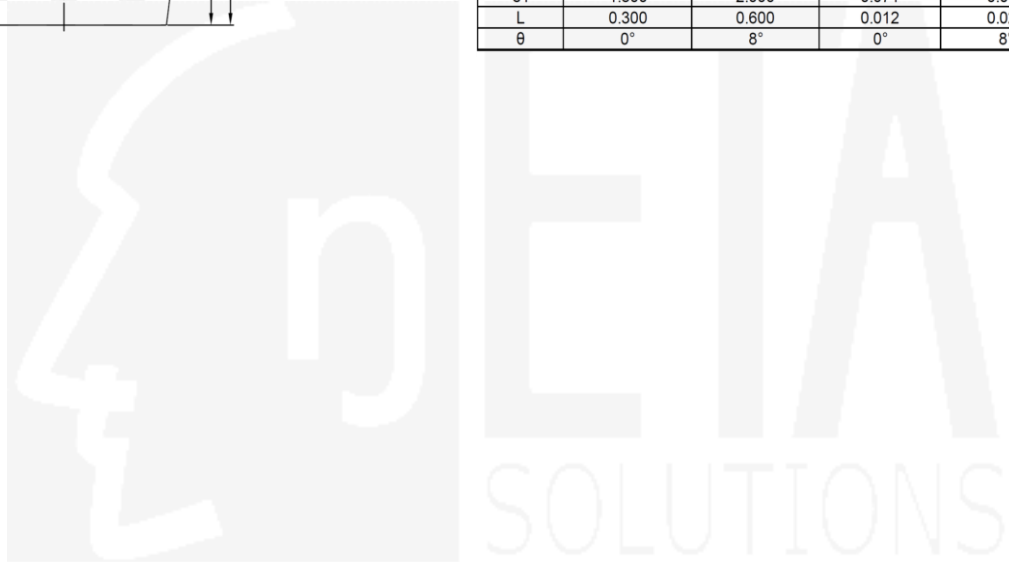

X-ON Electronics

Largest Supplier of Electrical and Electronic Components

Click to view similar products for [Isolated DC/DC Converters](#) category:

Click to view products by [etasolution](#) manufacturer:

Other Similar products are found below :

[PSL486-7LR](#) [Q48T30020-NBB0](#) [JAHW100Y1](#) [SPB05C-12](#) [SQ24S15033-PS0S](#) [CE-1003](#) [CE-1004](#) [MAU228](#) [J80-0041NL](#) [DFC15U48D15](#)
[XGS-1205](#) [06322](#) [SPB05B-15](#) [L-DA20](#) [DCG40-5G](#) [XKS-2405](#) [DPA423R](#) [vi-m13-cw-03](#) [VI-L53-CV](#) [24IBX15-50-0ZG](#) [HZZ01204-G](#)
[SPU02L-09](#) [SPU02M-09](#) [SPU02N-09](#) [QUINT4-BUFFER/24DC/40](#) [QUINT4-CAP/24DC/5/4KJ](#) [73-551-5039I](#) [DFC15U48D15G](#) [SEN-6471-](#)
[1EM](#) [AHV2815DF/HBB](#) [MI-LC21-IX](#) [PAH-48/8.5-D48NB1-C](#) [BM3020-7A](#) [QRS2050P025K00](#) [CM2320-9EG](#) [SKMW15F-05](#)
[V300A28H400BF3](#) [TEN 15-1223](#) [TEQ 100-2418WIR](#) [TEQ 160-7218WIR](#) [R05C05TE05S-R](#) [HQA2W085W033V-N07-S](#) [AM1SS-2405SJZ](#)
[AM2DS-1224SJZ](#) [AM2DS-2405DJZ](#) [AM10SBO-4824SNZ-B](#) [AM15E-2405S-NZ](#) [AM2DS-1212SJZ](#) [AM30SBO-4805SNZ-B](#)
[LT8301ES5#WTRPBF](#)