

## Ultra-High PSRR, Ultra-Low Iq, 500mA LDO for RF and Analog Circuits

### DESCRIPTION

ETA5055 is a low-dropout (LDO) linear voltage regulator that features ultra-high power supply rejection ratio (PSRR), ultra-low quiescent current, fast start-up, and excellent line and load transient responses. Its PSRR can be as high as 102dB at 1.2V output. Therefore, ETA5055 is an ideal power supply for noise-sensitive applications such as RF transmissions, cellphones, CMOS sensors and audios etc.

ETA5055 is available in DFN1X1-4, DFN2x2-6, SOT23-5, and CSP-4 packages.

### FEATURES

- ◆ Ultra-High PSRR up to 102dB  
Typ. 94dB at 1KHz
- ◆ Ultra-Low Quiescent Current: 4.5uA
- ◆ 500mA Output Current
- ◆ Ultra-Low Dropout Voltage
- ◆ Stable with a Wide Range of Ceramic Capacitor, Larger than 1μF
- ◆ Excellent Load and Line Transient Response
- ◆ RoHS Compliant

### APPLICATIONS

- ◆ RF Power
- ◆ Smartphones, Tablets
- ◆ Cameras, DVRs, STB

### TYPICAL APPLICATION

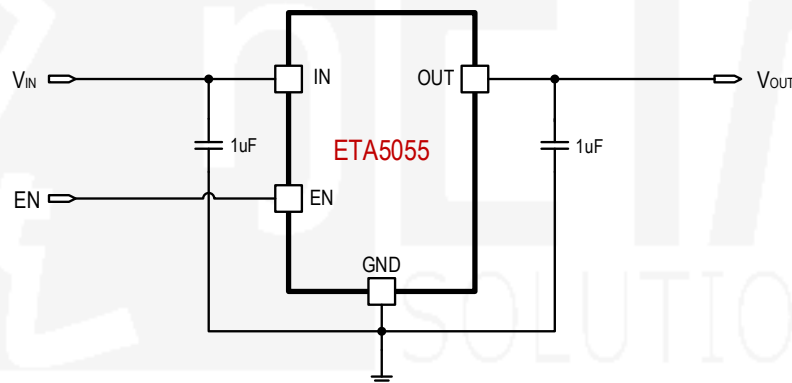

### ORDERING INFORMATION

PART No.	PACKAGE	TOP MARK	Pcs/Reel
ETA5055VXXXDS2F	SOT23-5	PPYW	3000
ETA5055VXXXDD2G	DFN2x2-6	PPYW	3000
ETA5055VXXXDD1E	DFN1x1-4	PP YW	10000
ETA5055VXXXDF1E	DFN1x1-4	PP YW	10000
ETA5055VXXXDCNE	CSP-4	P	10000
XXX: voltage code	e.g., <u>120</u> =1.2V	PP/P: product code	YW: data code

## PIN CONFIGURATION

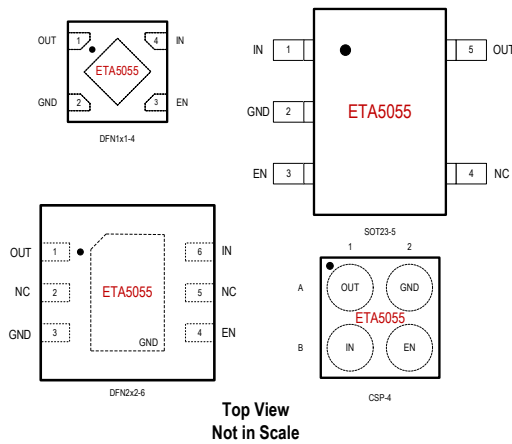

## ABSOLUTE MAXIMUM RATINGS

(Note: Exceeding these limits may damage the device. Exposure to absolute maximum rating conditions for long periods may affect device reliability.)

IN, EN, OUT Voltage.....	-0.3V to 6V	
Operating Temperature Range .....	-40°C to 85°C	
Storage Temperature Range .....	-55°C to 150°C	
Thermal Resistance	$\theta_{JA}$	$\theta_{JC}$
CSP-4.....	45.....	°C/W
SOT23-5.....	180.....90.....	°C/W
DFN1x1-4.....	120.....60.....	°C/W
DFN2x2-6.....	80.....30.....	°C/W
Lead Temperature (Soldering 10sec) .....	260°C	
ESD HBM (Human Body Mode).....	4KV	
ESD CDM (Charged Device Mode).....	1KV	

## ELECTRICAL CHARACTERISTICS

( $V_{IN} = V_{OUT} + 1V$ ,  $C_{IN} = 1\mu F$ ,  $C_{OUT} = 1\mu F$  unless otherwise specified. Typical values are at  $T_A = 25^\circ C$ .)

PARAMETER	CONDITIONS	MIN	TYP	MAX	UNIT
Input Voltage Range (1)		1.8		5.5	V
Quiescent Current	$I_{OUT} = 0mA$ , $V_{EN} = V_{IN}$		4.5		$\mu A$
Quiescent Current	$I_{OUT} = 0mA$ , Dropout		10		$\mu A$
Shutdown Current	$V_{EN} = 0V$ , $1.8V \leq V_{IN} \leq 5.5V$			1	$\mu A$
Dropout Voltage	$I_{OUT} = 200mA$ , $V_{OUT} = 2.8V$		130		mV
	$I_{OUT} = 200mA$ , $V_{OUT} = 3.3V$ (CSP-4)		90		mV
Continuous Output Current				500	mA
Output Current Limit	$V_{OUT} = 95\%$	540	800		mA
Output Foldback Current Limit	$V_{OUT} = 0V$		400		mA
Line Regulation	$V_{OUT} + 1V \leq V_{IN} \leq 5.5V$			0.2	%/V
Load Regulation	$1mA \leq I_{OUT} \leq 200mA$		15		mV
Output Voltage Range	Available in 100mV steps	1.1		3.6	V
Output Voltage Accuracy	$I_{OUT} = 30mA$ , $V_{OUT} > 1.8V$	-2		2	%
Power Supply Rejection Ratio	Freq = 100Hz, $I_{OUT} = 20mA$		96		dB
	Freq = 1KHz, $I_{OUT} = 20mA$		94		
Start-up Time			100		$\mu s$
EN pin input Logic Low	$1.8V \leq V_{IN} \leq 5.5V$			0.4	V
EN pin input Logic High	$1.8V \leq V_{IN} \leq 5.5V$	0.9			V
Discharge Resistance	$V_{IN} = 2.8V$ , $V_{EN} = 0V$		90		$\Omega$
Thermal Shutdown	Rising, $I_{OUT} > 1mA$ , Hysteresis = 40°C		140		°C
	Rising, $I_{OUT} = 0mA$ , Hysteresis = 40°C		135		°C

(1): Minimum  $V_{IN}$  is 1.8V or  $V_{OUT} + V_{DROPOUT}$ , whichever is greater.

## PIN DESCRIPTION

SOT23-5 PIN#	CSP-4 PIN#	DFN1x1-4 PIN#	DFN2x2-6 PIN#	NAME	DESCRIPTION
1	A2	4	6	IN	Input supply pin
2	B1	2	3	GND	Ground pin
3	B2	3	4	EN	Enable pin. Drive it high to enable IC, drive it low to disable IC.
4	NA	NA	2, 5	NC	Not Connected
5	A1	1	1	OUT	Output of regulator pin

## TYPICAL CHARACTERISTICS

(Typical values are at  $T_A = 25^\circ\text{C}$  unless otherwise specified.)

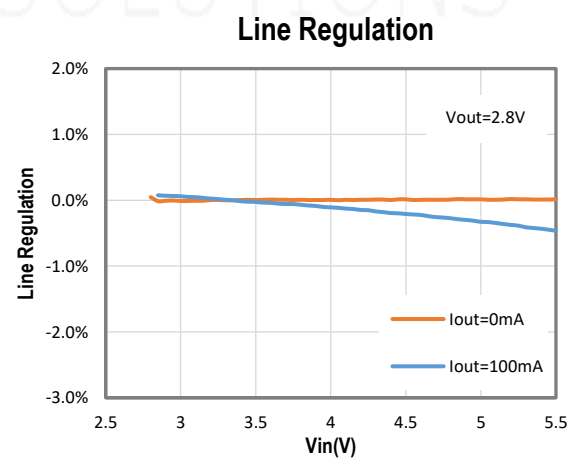
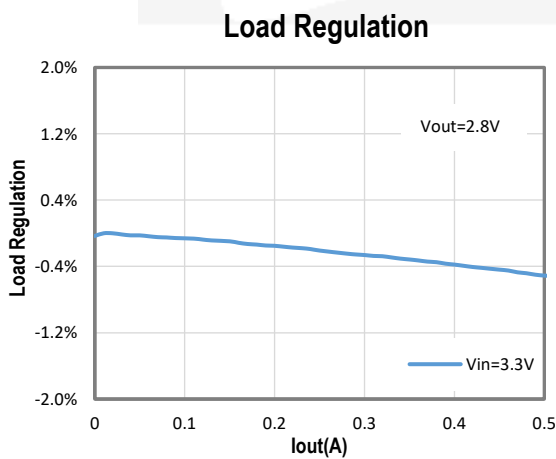
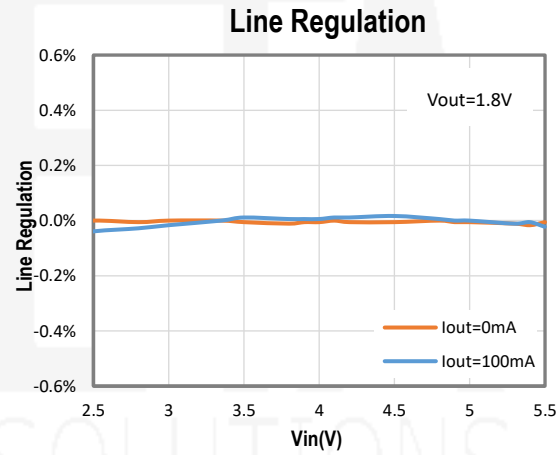
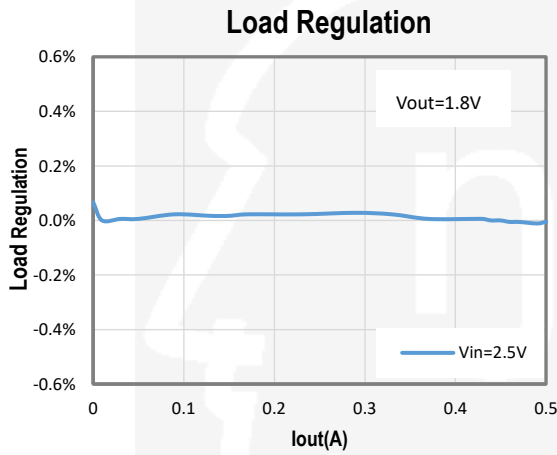

## TYPICAL CHARACTERISTICS Cont'd

(Typical values are at  $T_A = 25^\circ\text{C}$  unless otherwise specified.)

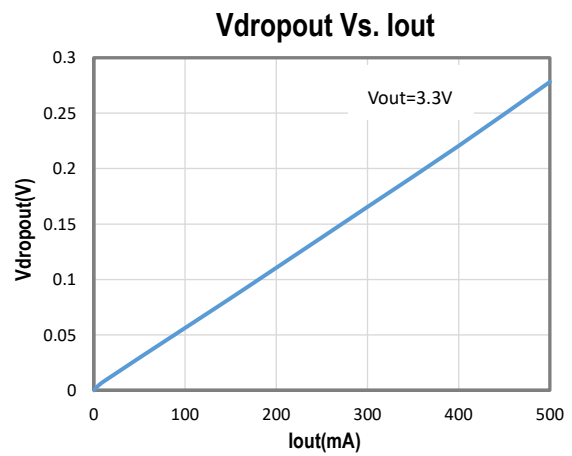
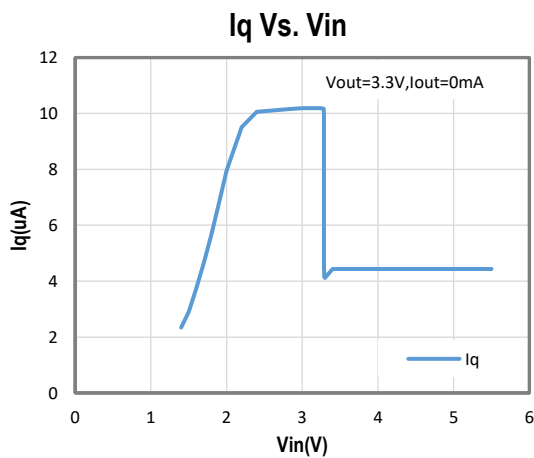
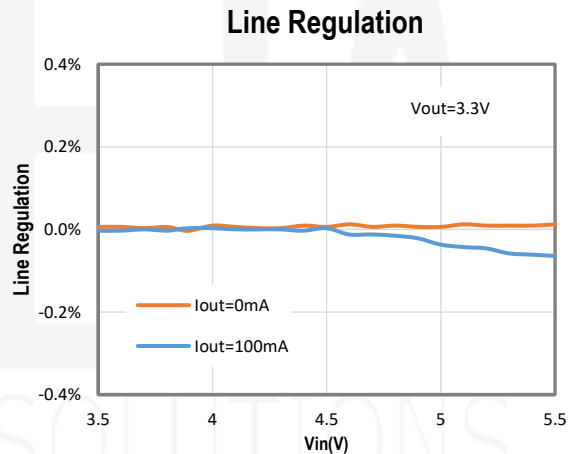
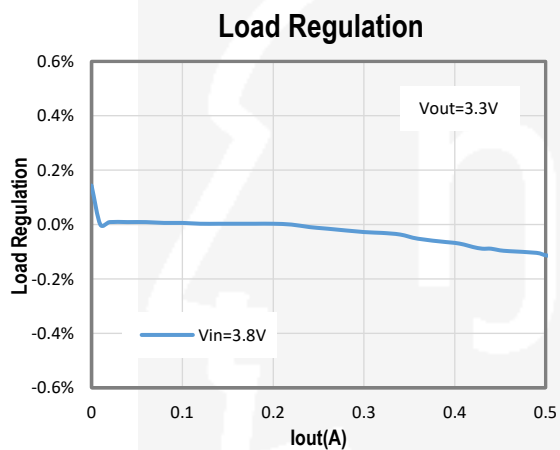
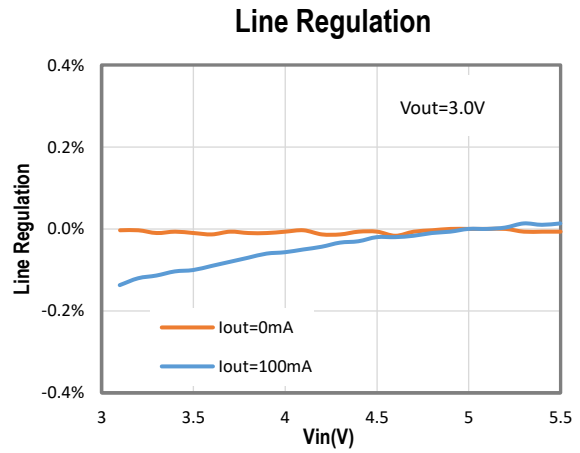
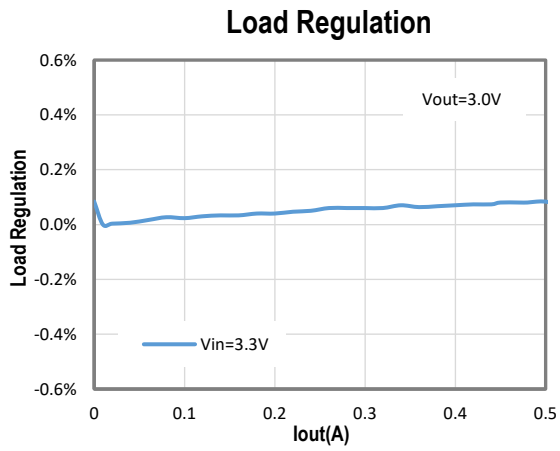

## TYPICAL CHARACTERISTICS Cont'd

(Typical values are at  $T_A = 25^\circ\text{C}$  unless otherwise specified.)

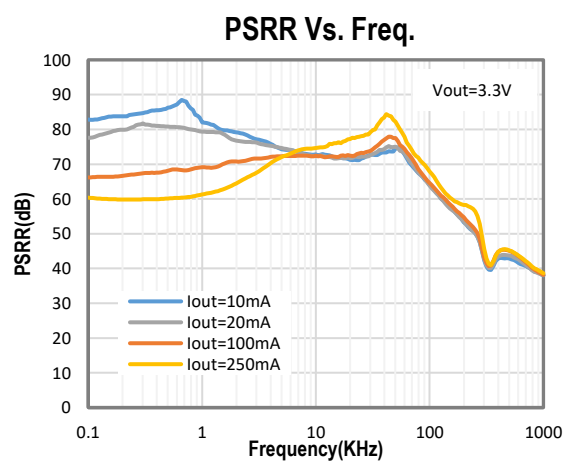
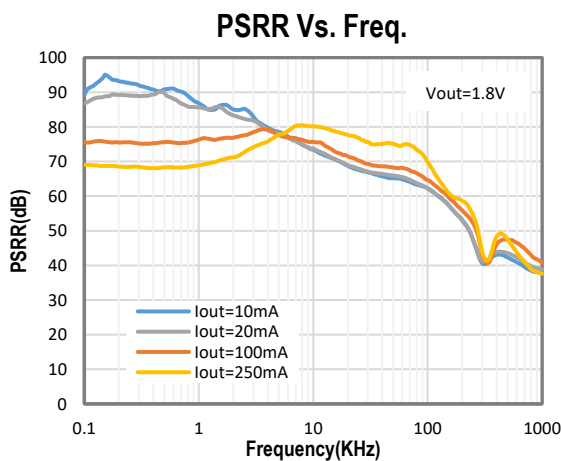
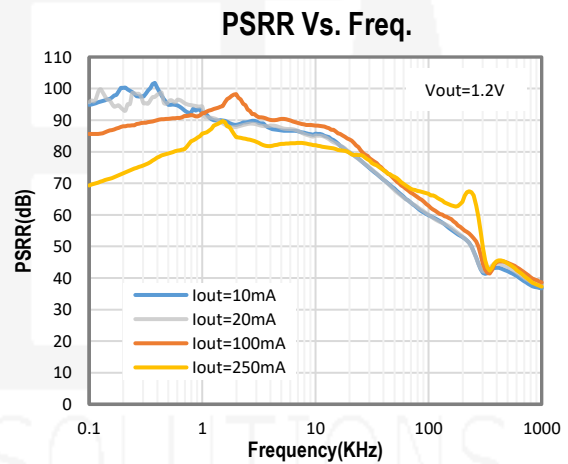
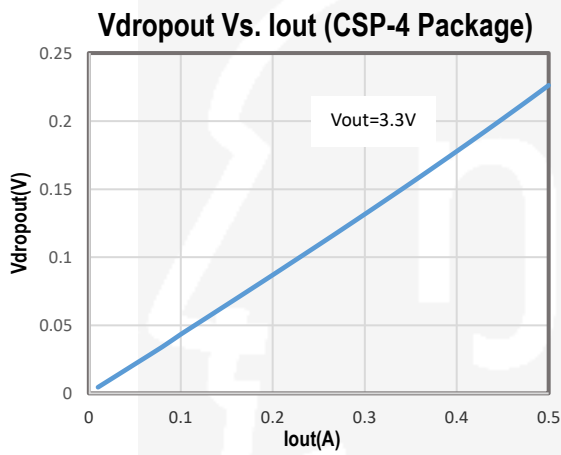
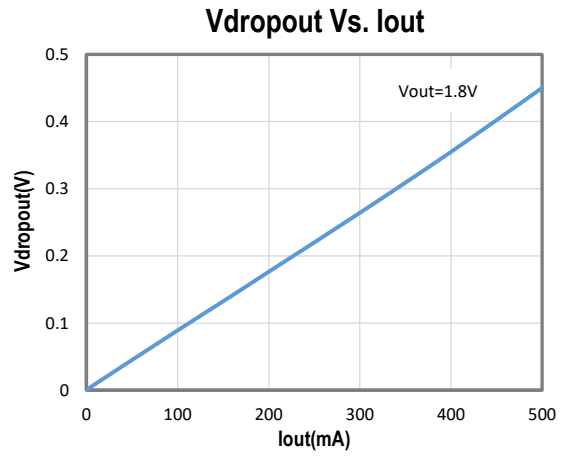
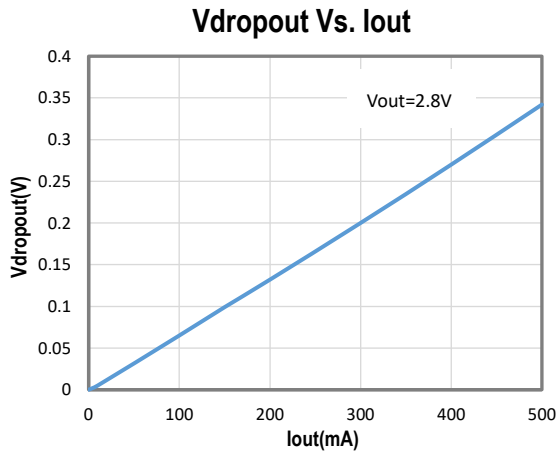

## TYPICAL CHARACTERISTICS Cont'd

(Typical values are at  $T_A = 25^\circ\text{C}$  unless otherwise specified.)

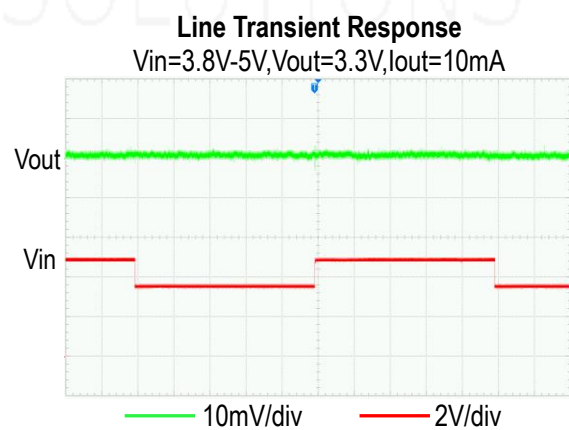
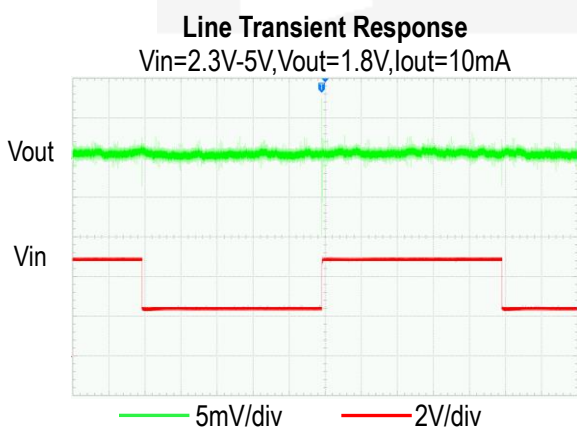
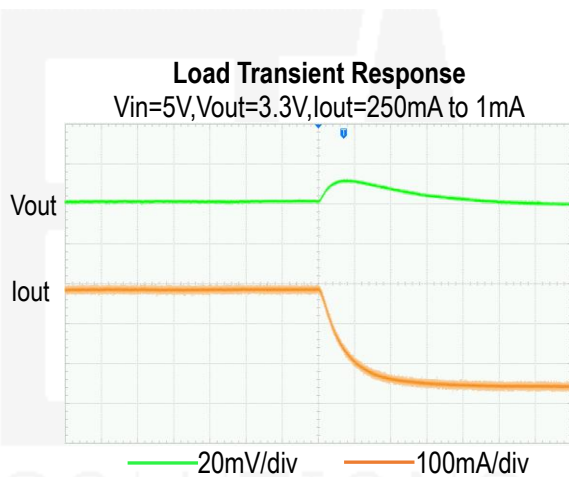
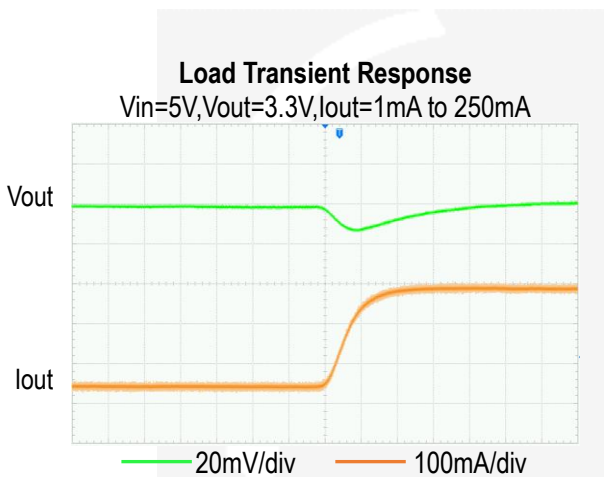
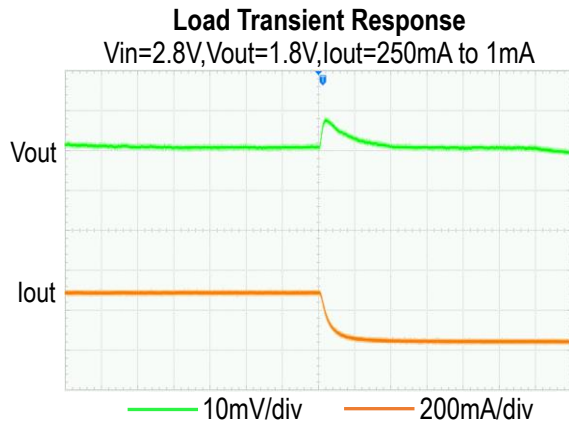
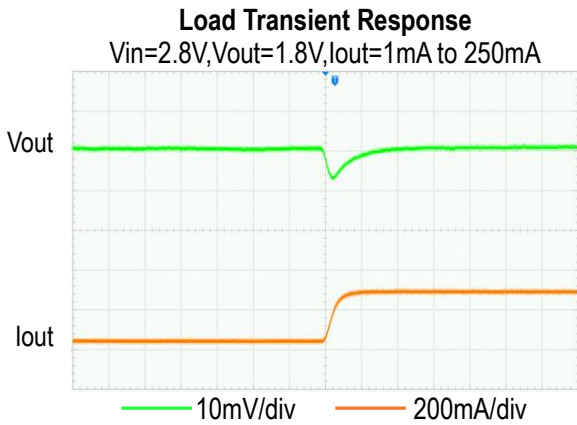

## FUNCTIONAL BLOCK DIAGRAM

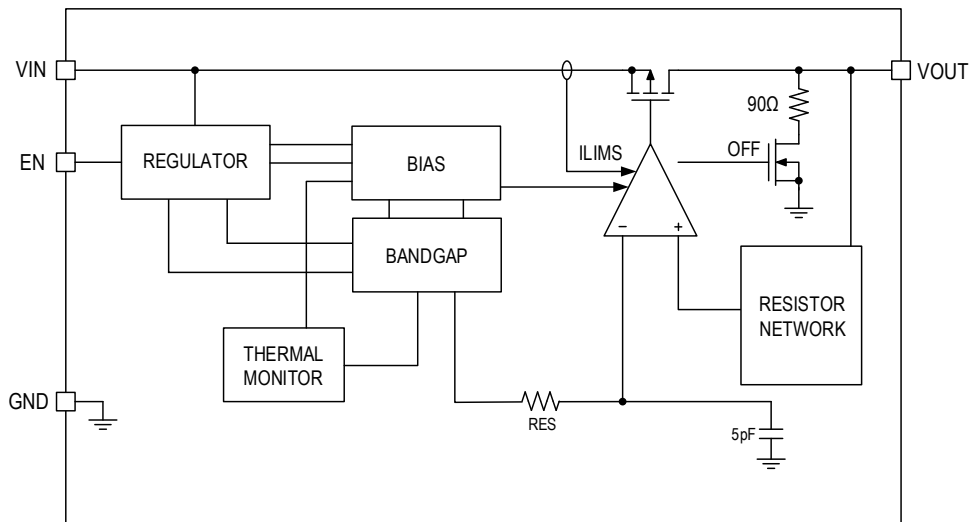

## FUNCTIONAL DESCRIPTION

The ETA5055 family of LDO regulators has been optimized for application in noise-sensitive equipment. The device features extremely low dropout voltages, high PSRR, low output noise, low quiescent current, and enable-input to reduce supply currents to less than 1 $\mu$ A when the regulator is turned off.

### Enable Sequence

ETA5055 is enabled when all below conditions happen. Otherwise, ETA5055 is in standby mode.

- ◆ EN pin voltage above Logic High level
- ◆ VIN is higher than Under-Voltage-Lock-Out Level.
- ◆ Junction Temperature is not at Over-Temperature Protection level.

Once all above conditions happen, ETA5055 first enable internal 2.4V regulator, before enable BIAS, and BANDGAP. Finally, when internal bias ready, ETA5055 enable LDO core.

ETA5055 is completed forced in shutdown mode when EN pin is at below LOGIC\_LOW that supply current is less than 1 $\mu$ A. Otherwise, part only shutdown the VOUT while other circuit still in operation. Once ETA5055 is in shutdown conditions, Output is discharged by 90 $\Omega$  resistor.

### Output Current Limit and Foldback Current Limit

ETA5055 family features an internal current limit. In normal operation, the ETA5055 limits output current to approximately 800mA. When current limiting engages, the output voltage scales back linearly until the over current condition ends.

In case output is in hard short conditions, ETA5055 also features an internal foldback limit that reduces the output current limit to a lower level, 400mA, then reduce power dissipation ratings of the package.

### Over-Temperature Protection

Thermal protection disables the output when the junction temperature rises to approximately 150 $^{\circ}$ C, allowing the device to cool down. When the junction temperature cools to approximately 120 $^{\circ}$ C, the output circuitry is again enabled. Depending on power dissipation, thermal resistance, and ambient temperature, the thermal protection circuit may cycle on and off. This cycling limits regulator dissipation, protecting the device from damage as a result of overheating.

## PACKAGE OUTLINE

Package: SOT23-5  
 ETA5055VXXDS2F

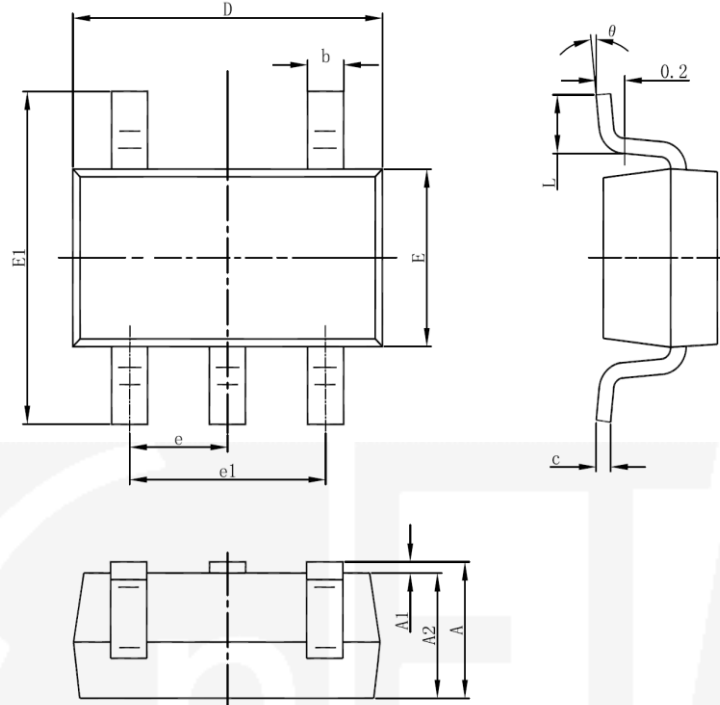

Symbol	Dimensions In Millimeters		Dimensions In Inches	
	Min	Max	Min	Max
A	1.050	1.250	0.041	0.049
A1	0.000	0.100	0.000	0.004
A2	1.050	1.150	0.041	0.045
b	0.300	0.500	0.012	0.020
c	0.100	0.200	0.004	0.008
D	2.820	3.020	0.111	0.119
E	1.500	1.700	0.059	0.067
E1	2.650	2.950	0.104	0.116
e	0.950(BSC)		0.037(BSC)	
e1	1.800	2.000	0.071	0.079
L	0.300	0.600	0.012	0.024
θ	0°	8°	0°	8°

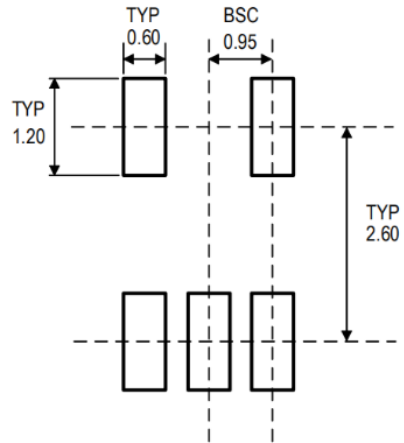

RECOMMENDED LAND PATTERN



## PACKAGE OUTLINE

Package: CSP-4  
 ETA5055VXXDCNE

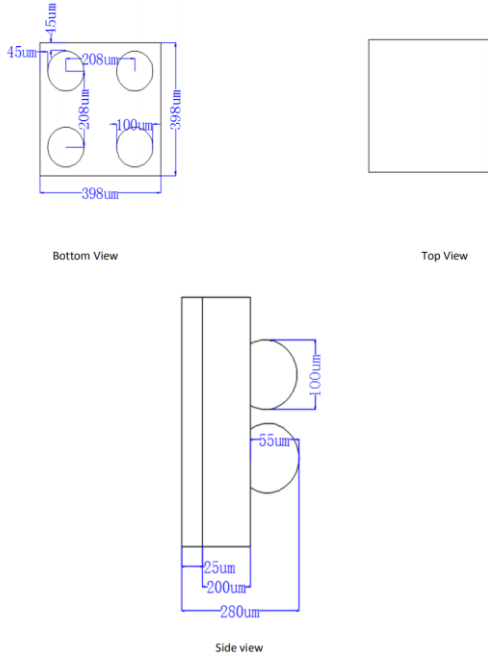

Parameter	Min	Normal	Max
	Millimeters		
Package body dimension X	0.378	0.398	0.418
Package body dimension Y	0.378	0.398	0.418
Package Height	0.26	0.28	0.3
SI thickness	0.1875	0.2	0.2125
Bump Height	0.04	0.055	0.07
Bump Diameter	0.092	0.1	0.108
Total Ball Count Per Die	/	4	/
Ball Pitch X axis (min)	/	0.208	/
Ball Pitch Y axis (min)	/	0.208	/

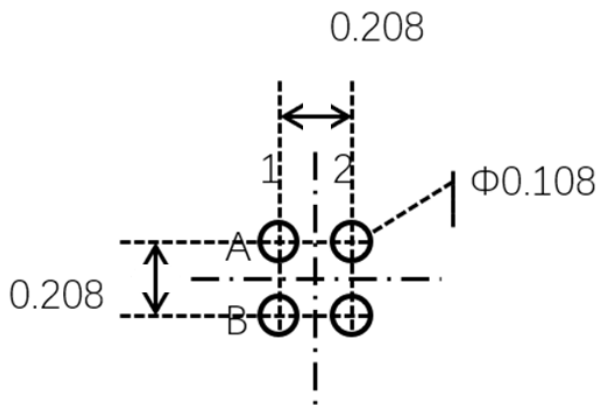

RECOMMENDED LAND PATTERN

Package: DFN1x1-4

From assembly house1: ETA5055VXXXDF1E

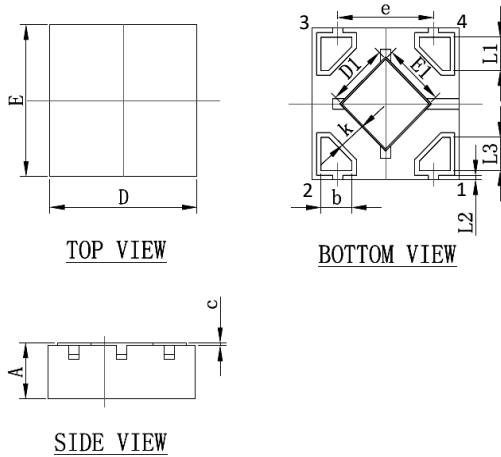

Symbol	Dimensions In Millimeters		Dimensions In Inches	
	Min.	Max.	Min.	Max.
A	0.335	0.400	0.013	0.016
D	0.950	1.050	0.037	0.041
E	0.950	1.050	0.037	0.041
D1	0.370	0.470	0.015	0.019
E1	0.370	0.470	0.015	0.019
k	0.17MIN.		0.007MIN.	
b	0.160	0.260	0.006	0.010
c	0.010	0.090	0.000	0.004
e	0.600	0.700	0.024	0.028
L1	0.185	0.255	0.007	0.010
L2	0.030 REF.		0.001 REF.	
L3	0.185	0.255	0.007	0.010

From assembly house2: ETA5055VXXXDD1E

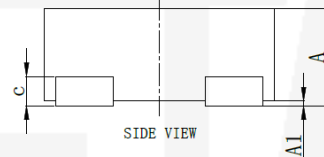
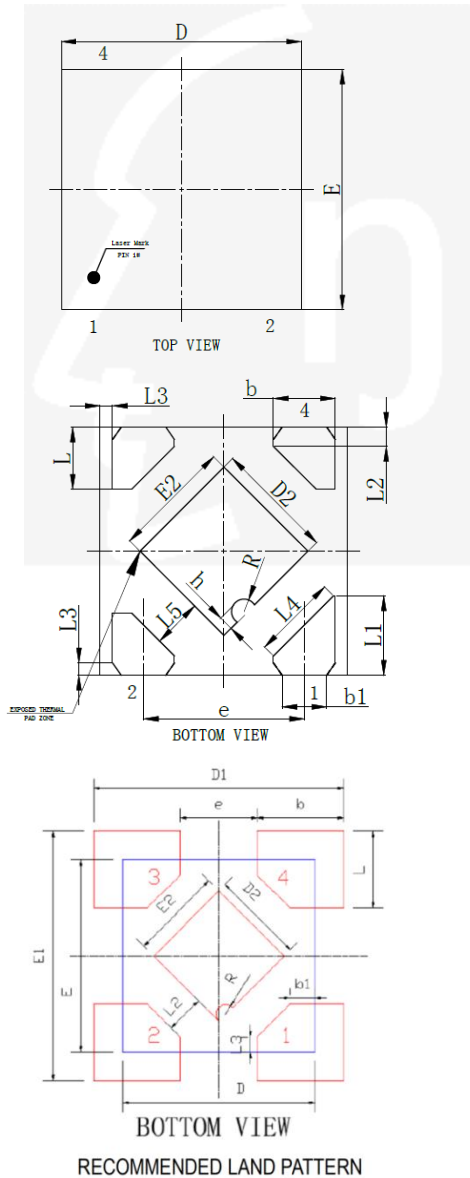

SYMBOL	MILLIMETER		
	MIN	NOM	MAX
A	0.35	-	0.40
A1	0.00	0.02	0.05
b	0.20	0.25	0.30
b1	0.13	0.18	0.23
c	0.07	0.12	0.17
D	0.95	1.00	1.05
D2	0.43	0.48	0.53
e	0.65BSC		
E	0.95	1.00	1.05
E2	0.43	0.48	0.53
L	0.20	0.25	0.30
L1	0.27	0.32	0.37
L2	0.077REF		
L3	0.05REF		
L4	0.34REF		
L5	0.20REF		
R	0.05REF		
h	0.06REF		

Dimensions	Value (in mm)
D	1
E	1
D1	1.3
E1	1.3
D2	0.48
E2	0.48
R	0.05
e	0.4
b	0.45
L	0.4
b 1	0.13
L3	0.08
L2	0.2(≥0.2)

Package: DFN2x2-6  
ETA5055VXXDD2G

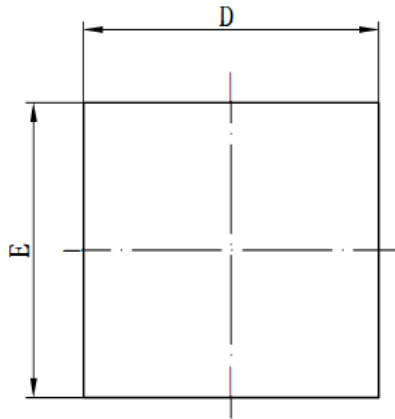

TOP VIEW

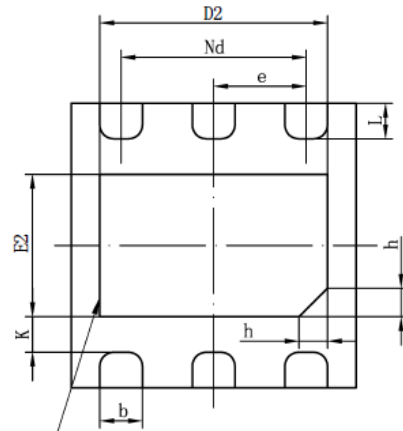

EXPOSED THERMAL PAD ZONE

BOTTOM VIEW

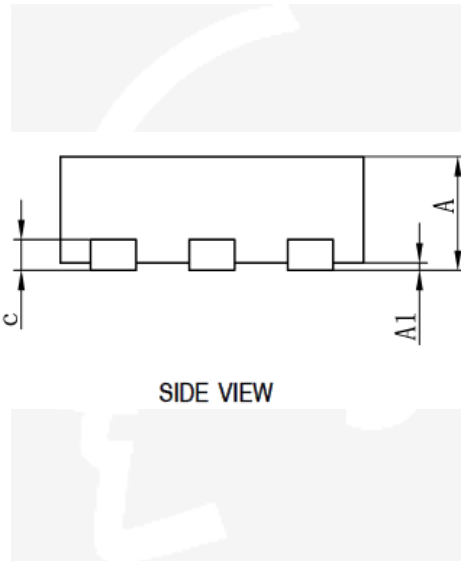

SIDE VIEW

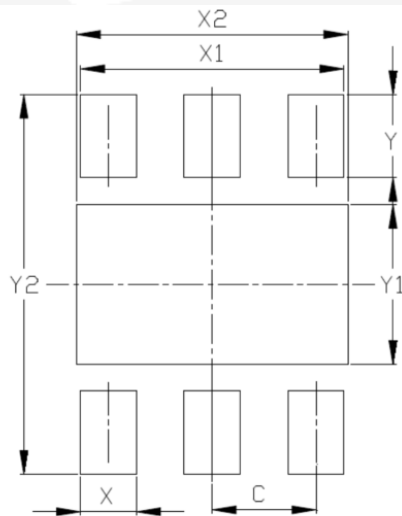

RECOMMENDED LAND PATTERN

SYMBOL	MILLIMETER		
	MIN	NOM	MAX
A	0.70	0.75	0.80
A1	0	0.02	0.05
b	0.25	0.30	0.35
c	0.18	0.20	0.25
D	1.90	2.00	2.10
D2	1.50	1.60	1.70
e	0.65BSC		
Nd	1.30BSC		
E	1.90	2.00	2.10
E2	0.90	1.00	1.10
K	0.20	-	-
L	0.20	0.25	0.30
h	0.15	0.20	0.25
L/F载体尺寸 (MIL)	69X47		

Dimensions	Value (in mm)
C	0.650
X	0.350
X1	1.650
X2	1.700
Y	0.550
Y1	1.100
Y2	2.600

## AVAILABLE PART NUMBER

Part Description	Part Number	Package	Mark	Pcs/Reel
1.2V With Discharge CSP-4	ETA5055V120DCNE	CSP-4	B	10000
1.8V With Discharge CSP-4	ETA5055V180DCNE	CSP-4	D	10000
2.8V With Discharge CSP-4	ETA5055V280DCNE	CSP-4	F	10000
3.3V With Discharge CSP-4	ETA5055V330DCNE	CSP-4	K	10000
1.1V with Discharge DFN1x1-4	ETA5055V110DD1E	DFN1x1-4	ev <u>YW</u>	10000
1.2V with Discharge DFN1x1-4	ETA5055V120DD1E	DFN1x1-4	CD <u>YW</u>	10000
1.5V with Discharge DFN1x1-4	ETA5055V150DD1E	DFN1x1-4	CN <u>YW</u>	10000
1.8V with Discharge DFN1x1-4	ETA5055V180DD1E	DFN1x1-4	CX <u>YW</u>	10000
2.8V with Discharge DFN1x1-4	ETA5055V280DD1E	DFN1x1-4	C8 <u>YW</u>	10000
2.9V with Discharge DFN1x1-4	ETA5055V290DD1E	DFN1x1-4	eq <u>YW</u>	10000
3.0V with Discharge DFN1x1-4	ETA5055V300DD1E	DFN1x1-4	Cy <u>YW</u>	10000
3.3V with Discharge DFN1x1-4	ETA5055V330DD1E	DFN1x1-4	Ck <u>YW</u>	10000
1.1V with Discharge DFN1x1-4	ETA5055V110DF1E	DFN1x1-4	ev <u>YW</u>	10000
1.2V with Discharge DFN1x1-4	ETA5055V120DF1E	DFN1x1-4	CD <u>YW</u>	10000
1.5V with Discharge DFN1x1-4	ETA5055V150DF1E	DFN1x1-4	CN <u>YW</u>	10000
1.8V with Discharge DFN1x1-4	ETA5055V180DF1E	DFN1x1-4	CX <u>YW</u>	10000
2.8V with Discharge DFN1x1-4	ETA5055V280DF1E	DFN1x1-4	C8 <u>YW</u>	10000
2.9V with Discharge DFN1x1-4	ETA5055V290DF1E	DFN1x1-4	eq <u>YW</u>	10000
3.0V with Discharge DFN1x1-4	ETA5055V300DF1E	DFN1x1-4	Cy <u>YW</u>	10000
3.3V with Discharge DFN1x1-4	ETA5055V330DF1E	DFN1x1-4	Ck <u>YW</u>	10000
1.1V with Discharge SOT23-5	ETA5055V110DS2F	SOT23-5	ev <u>YW</u>	3000
1.2V with Discharge SOT23-5	ETA5055V120DS2F	SOT23-5	WD <u>YW</u>	3000
1.5V with Discharge SOT23-5	ETA5055V150DS2F	SOT23-5	WN <u>YW</u>	3000
1.8V with Discharge SOT23-5	ETA5055V180DS2F	SOT23-5	WX <u>YW</u>	3000
2.5V with Discharge SOT23-5	ETA5055V250DS2F	SOT23-5	WJ   <u>YW</u>	3000

Part Description	Part Number	Package	Mark	Pcs/Reel
2.8V with Discharge SOT23-5	ETA5055V280DS2F	SOT23-5	W8YW	3000
2.9V with Discharge SOT23-5	ETA5055V290DS2F	SOT23-5	WS   YW	3000
3.0V with Discharge SOT23-5	ETA5055V300DS2F	SOT23-5	WyYW	3000
3.3V with Discharge SOT23-5	ETA5055V330DS2F	SOT23-5	WkYW	3000
1.1V with Discharge DFN2X2-6	ETA5055V110DD2G	DFN2X2-6	evYW	3000
1.2V with Discharge DFN2X2-6	ETA5055V120DD2G	DFN2X2-6	CDYW	3000
1.5V with Discharge DFN2X2-6	ETA5055V150DD2G	DFN2X2-6	CNYW	3000
1.8V with Discharge DFN2X2-6	ETA5055V180DD2G	DFN2X2-6	CXYW	3000
2.5V with Discharge DFN2X2-6	ETA5055V250DD2G	DFN2X2-6	CJ   YW	3000
2.8V with Discharge DFN2X2-6	ETA5055V280DD2G	DFN2X2-6	C8YW	3000
3.0V with Discharge DFN2X2-6	ETA5055V300DD2G	DFN2X2-6 <td CyYW	3000	
3.3V with Discharge DFN2X2-6	ETA5055V330DD2G	DFN2X2-6	CKYW	3000

## TAPE AND REEL INFORMATION

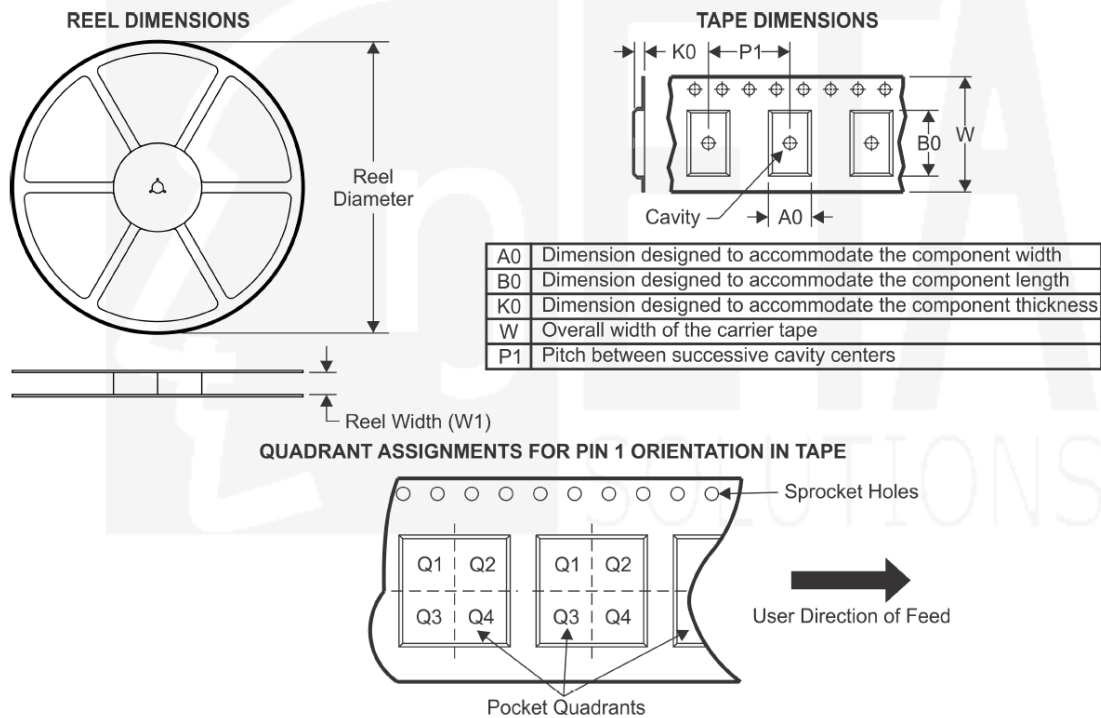

Device	Package Type	Pins	SPQ	Reel Diameter (mm)	Reel Width W1 (mm)	A0 (mm)	B0 (mm)	K0 (mm)	P1 (mm)	W (mm)	Pin1 Quadrant
ETA5055VXXXDCNE	CSP-4	4	10000	178	9.5	0.45	0.45	0.34	2	8	Q1
ETA5055VXXXDD1E	DFN1x1-4	4	10000	180	9.5	1.16	1.16	0.5	2	8	Q1
ETA5055VXXXDF1E	DFN1x1-4	4	10000	180	9.5	1.16	1.16	0.5	2	8	Q1
ETA5055VXXXDD2G	DFN2x2-6	6	3000	180	9.5	2.3	2.3	1.1	4	8	Q1
ETA5055VXXXDS2F	SOT23-5	5	3000	180	9.5	3.17	3.23	1.37	4	8	Q3

## X-ON Electronics

Largest Supplier of Electrical and Electronic Components

*Click to view similar products for [LDO Voltage Regulators](#) category:*

*Click to view products by [etasolution](#) manufacturer:*

Other Similar products are found below :

[AP7363-SP-13](#) [NCV8664CST33T3G](#) [L79M05TL-E](#) [AP7362-HA-7](#) [PT7M8202B12TA5EX](#) [TCR3DF185,LM\(CT](#) [TLF4949EJ](#)  
[NCP4687DH15T1G](#) [NCV8703MX30TCG](#) [LP2951CN](#) [NCV4269CPD50R2G](#) [AP7315-25W5-7](#) [NCV47411PAAJR2G](#) [AP2111H-1.2TRG1](#)  
[ZLDO1117QK50TC](#) [AZ1117ID-ADJTRG1](#) [NCV4263-2CPD50R2G](#) [NCP114BMX075TCG](#) [MC33269T-3.5G](#) [TLE4471GXT](#) [AP7315-33SA-](#)  
[7](#) [NCV4266-2CST33T3G](#) [NCP715SQ15T2G](#) [NCV8623MN-50R2G](#) [NCV563SQ18T1G](#) [NCV8664CDT33RKG](#) [NCV4299CD250R2G](#)  
[NCP715MX30TBG](#) [NCV8702MX25TCG](#) [L974113TR](#) [TLE7270-2E](#) [NCV562SQ25T1G](#) [AP2213D-3.3TRG1](#) [AP2202K-2.6TRE1](#)  
[NCV8170BMX300TCG](#) [NCV8152MX300180TCG](#) [NCP700CMT45TBG](#) [AP7315-33W5-7](#) [LD56100DPU28R](#) [NCP154MX180300TAG](#)  
[AP2210K-3.0TRE1](#) [AP2113AMTR-G1](#) [NJW4104U2-33A-TE1](#) [MP2013AGG-5-P](#) [NCV8775CDT50RKG](#) [NJM2878F3-45-TE1](#) [S-](#)  
[19214B00A-V5T2U7](#) [S-19214B50A-V5T2U7](#) [S-19213B50A-V5T2U7](#) [S-19214BC0A-E8T1U7\\*1](#)