

## Programmable Current-Limited Load Switch

### DESCRIPTION

The ETA6027 is a load switch which provides full protection to systems and loads which may encounter large current conditions. ETA6027 offers a 70mΩ current-limited switch which can operate over an input voltage range of 2.1-6V. The current limit can be externally programmed by a precision resistor, ranges from 75mA to 2.2A. Switch control is executed by a logic input (EN) capable of interfacing directly with low voltage control signals. Current is prevented from flowing when the switch is off or the output voltage is higher than the input voltage. ETA6027 also features thermal shutdown protection which shuts off the switch to prevent damage to the part when a continuous over-current condition causes excessive heating. When the switch current reaches the current limit, the part operates in a constant-current mode to prohibit excessive currents from causing damage. The ETA6027 will not turn off after a current limit fault, but will rather remain in the constant current mode indefinitely. The nFAULT output asserts low during over-current and reverse-voltage conditions.

ETA6027 is available in three types of package: SOT23-5, SOT23-6, DFN2x2-6

### FEATURES

- ◆ Input Operating Voltage Range: 2.1V to 6V
- ◆ 7.5V Input Standoff Voltage
- ◆ 6.1V OVP
- ◆ Up to 2.2A Max Load current
- ◆ Programmable Current-limit: 75mA to 2200mA
- ◆ Accurate Current-Limit Threshold at 1.7A: +/-5%
- ◆ Fast Over-Current Response
- ◆ Fault Flag Output: nFAULT Pin
- ◆ Reversed Input-Output Current blocking
- ◆ Thermal Shutdown, UVLO protection
- ◆ Tiny SOT23-5, SOT23-6, DFN2x2-6 Package

### APPLICATIONS

- ◆ USB Ports and Hubs
- ◆ Digital TVs
- ◆ Set-Top Boxes
- ◆ VOIP Phones

### TYPICAL APPLICATION

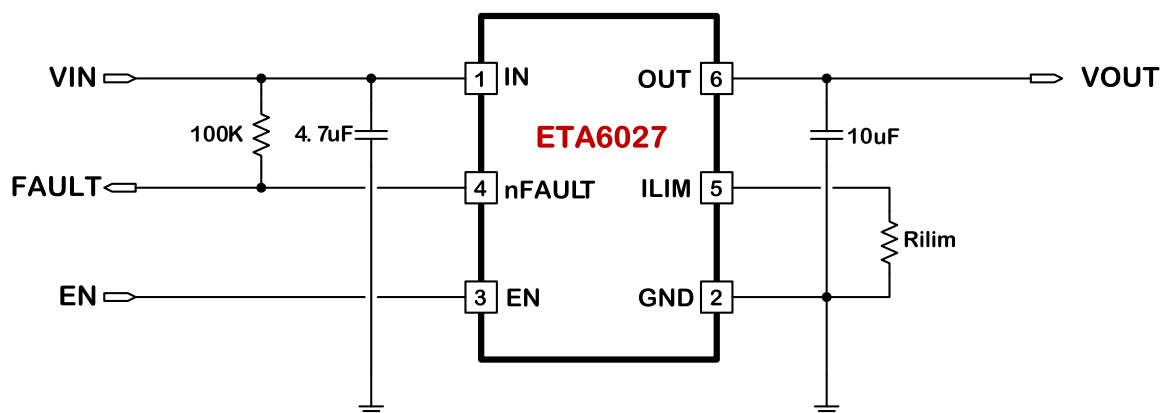

\* Pin out number is for SOT23-6 package

## ORDERING INFORMATION

PART No.	PACKAGE	TOP MARK	Pcs/Reel
ETA6027S2F	SOT23-5	HMYW	3000
ETA6027S2G	SOT23-6	HMYW	3000
ETA6027D2G	DFN2x2-6	HMYW	3000

## PIN CONFIGURATION

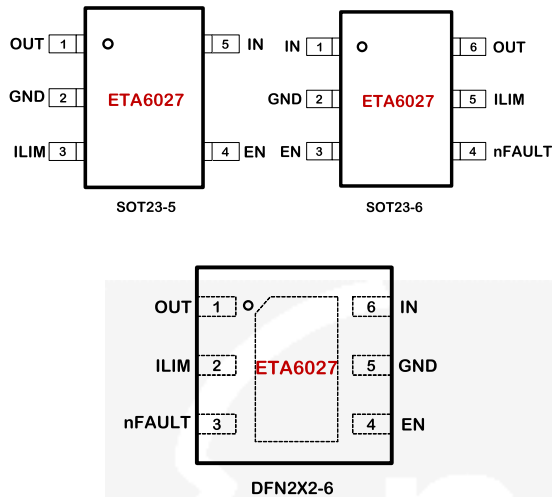

## ABSOLUTE MAXIMUM RATINGS

(Note: Exceeding these limits may damage the device. Exposure to absolute maximum rating conditions for long periods may affect device reliability.)

IN, OUT Voltage to GND .....	-0.3V to 7.5V
All other Pin Voltage to GND .....	-0.3V to 7.5V
OUT to ground current.....	Internally limited
Operating Temperature Range .....	-40°C to 85°C
Storage Temperature Range .....	-55°C to 150°C
Thermal Resistance $\theta_{JC}$ $\theta_{JA}$	
DFN2x2-6 .....	30.....80.....°C/W
SOT23-6.....	90.....180.....°C/W
SOT23-5.....	90.....180.....°C/W
Lead Temperature (Soldering, 10sec) .....	260°C

## ELECTRICAL CHARACTERISTICS

( $V_{IN} = 5V$ , unless otherwise specified. Typical values are at  $T_A = 25^\circ C$ .)

PARAMETER	SYMBOL	TEST CONDITIONS	MIN	TYP	MAX	UNIT
Input Operating Voltage Range	VIN_RANGE		2.1		6	V
Input OVP	OVP	Rising, Hysteresis=200mV		6.1		V
Input UVLO	UVLO	Rising, Hysteresis=100mV		2.0		V
Input Supply Current	IQ	$R_{ILIM}=20K$		100		$\mu A$
Input Shutdown Current	ISD			0.9		$\mu A$
Power Switch On Resistance	RON	$I_{SW} = 500mA$		70		m $\Omega$
		$I_{SW} = 500mA, -40^\circ C \leq T_J \leq 120^\circ C$			130	m $\Omega$
Current limit Threshold	ILIM	$R_{ILIM}=15K$		1.705		A
		$R_{ILIM}=20K$		1.295		A
		$R_{ILIM}=49.9K$		0.525		A
Forward regulation voltage	VFW	Light Load		25		mV
Response time to Short-circuit	TSHORT			1		$\mu s$
Reverse Indication Threshold	VREV	$V_{OUT}-V_{IN}$		150		mV
Reverse Leakage Current	VIN_LKG	$V_{OUT}=5.5V, V_{IN}=0V, V_{EN}=High$		0.5	2	$\mu A$
EN Input Logic High threshold	VIN_HI	EN Voltage Rising	1			V
EN Input Logic Low threshold	VIN_LO	EN Voltage Falling			0.4	V
nFAULT Output Low Voltage	VO_LO	$I_{nFAULT} = 1mA$		70	170	mV
Output Discharge resistance	RDIS	$V_{EN}=0V$		300		$\Omega$

PARAMETER	SYMBOL	TEST CONDITIONS	MIN	TYP	MAX	UNIT
nFAULT Output Leakage	FLT_LKG				1	μA
nFAULT Deglitch Time	TF_ILIM	De-assertion due to Over-current		9		ms
	TF_REV	De-assertion due to Reverse-Voltage		4.5		ms
Thermal Shutdown	TSD			160		°C
Thermal Shutdown In Current Limit	TSD_ILIM			135		°C
Thermal Shutdown Hysteresis	TSD_HYS			10		°C

## PIN DESCRIPTION

PIN NAME	PACKAGE			DESCRIPTION
	SOT23-5	SOT23-6	DFN2x2-6	
IN	5	1	6	Power input. Bypass with a 4.7μF capacitor to GND
OUT	1	6	1	Current limit Output. 10uF is recommended for output capacitor.
GND	2	2	5	Ground
ILIM	3	5	2	Current limit threshold setting pin. Connect a resistor (Rlimit) from this pin to GND to set different current limit values.
EN	4	3	4	Enable Input Pin. Drive this pin high to enable, low to disable.
nFAULT	N/A	4	3	Fault flagging pin. Connect a pull up resistor to IN, when in FAULT conditions, this pin is asserted low.
EP	N/A	N/A	EP	Thermal Pad. Used to sink the heat through the circuit board traces. Connect EP to GND on board.

FUNCTIONAL BLOCK DIAGRAM

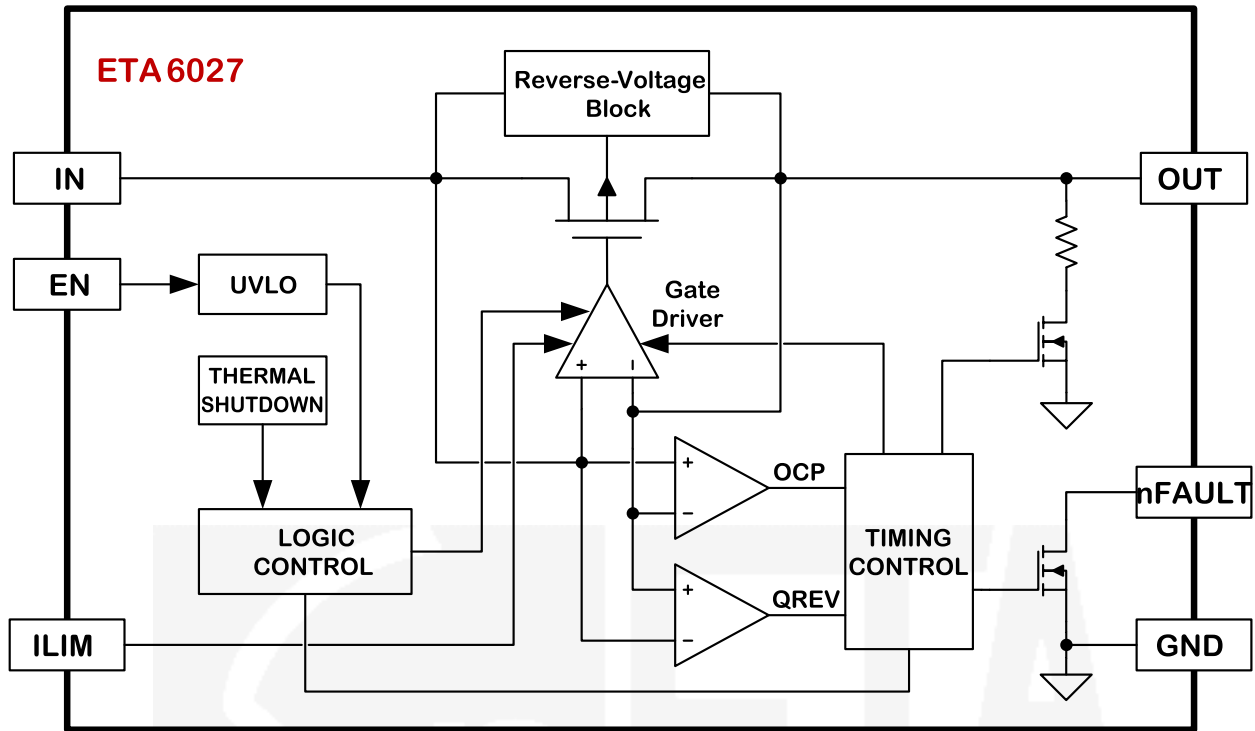

TYPICAL PERFORMANCE CHARACTERISTICS

( $T_A=25^{\circ}\text{C}$ , unless otherwise specified)

Turn-on Delay and Rise Time,  $V_{IN} = 5\text{V}$ ,  $R_{ILIM} = 20\text{k}\Omega$ ,  $R_{OUT}=5\Omega$ ,  
 $C_{OUT} = 10\mu\text{F}(\text{Ceramic})+100\mu\text{F}(\text{ECAP})$

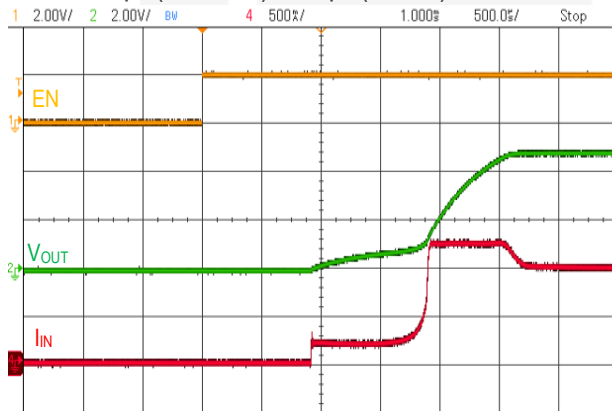

Turn-off Delay and Fall Time,  $V_{IN} = 5\text{V}$ ,  $R_{ILIM} = 20\text{k}\Omega$ ,  $R_{OUT}=5\Omega$ ,  
 $C_{OUT} = 10\mu\text{F}(\text{Ceramic})+100\mu\text{F}(\text{ECAP})$

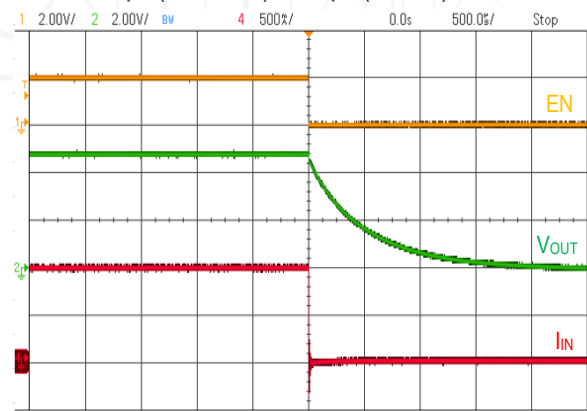

TYPICAL PERFORMANCE CHARACTERISTICS CONT'D

( $T_A=25^{\circ}\text{C}$ , unless otherwise specified)

Turn-on Delay and Rise Time,  $V_{IN} = 5\text{V}$ ,  $R_{LIM} = 20\text{k}\Omega$ ,  $R_{OUT}=5\Omega$ ,  
 $C_{OUT} = 10\mu\text{F}(\text{Ceramic})+47\mu\text{F}(\text{ECAP})$

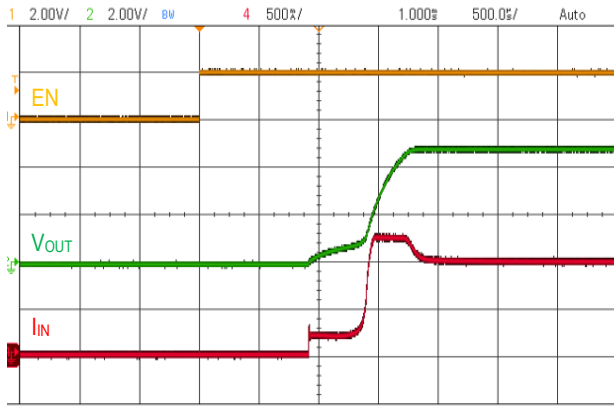

Turn-off Delay and Fall Time,  $V_{IN} = 5\text{V}$ ,  $R_{LIM} = 20\text{k}\Omega$ ,  $R_{OUT}=5\Omega$ ,  
 $C_{OUT} = 10\mu\text{F}(\text{Ceramic})+47\mu\text{F}(\text{ECAP})$

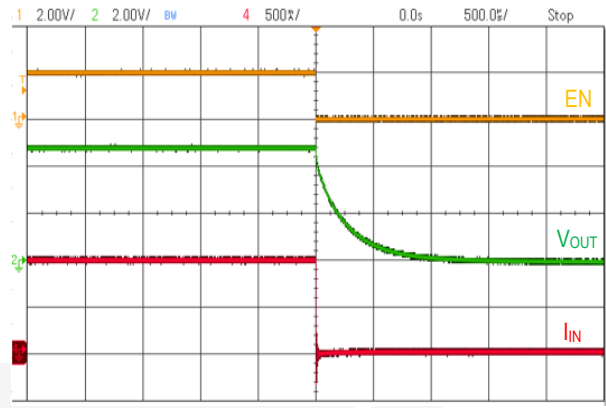

Turn-on Delay and Rise Time,  $V_{IN} = 5\text{V}$ ,  $R_{LIM} = 20\text{k}\Omega$ ,  $R_{OUT}=5\Omega$ ,  
 $C_{OUT} = 10\mu\text{F}(\text{Ceramic})+10\mu\text{F}(\text{ECAP})$

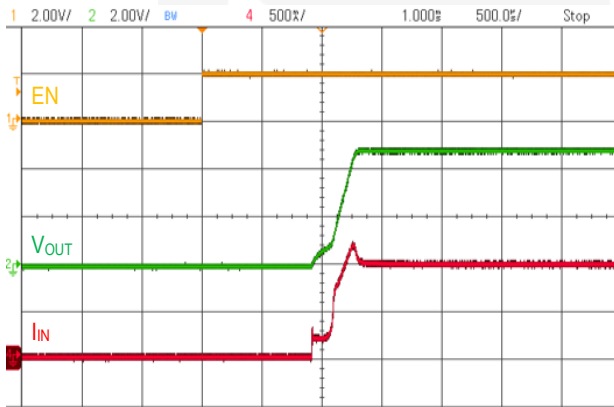

Turn-off Delay and Fall Time,  $V_{IN} = 5\text{V}$ ,  $R_{LIM} = 20\text{k}\Omega$ ,  $R_{OUT}=5\Omega$ ,  
 $C_{OUT} = 10\mu\text{F}(\text{Ceramic})+10\mu\text{F}(\text{ECAP})$

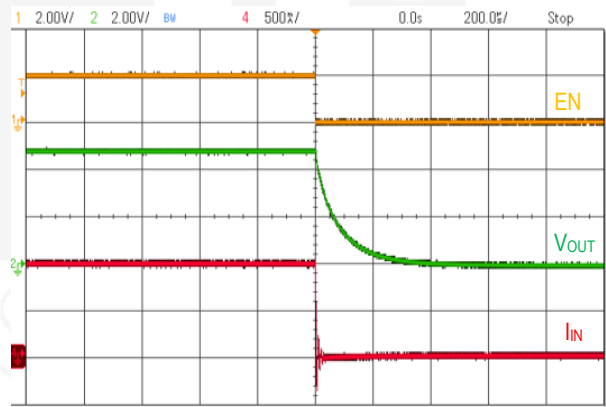

Turn-on Delay and Rise Time,  $V_{IN} = 5\text{V}$ ,  $R_{LIM} = 20\text{k}\Omega$ ,  $R_{OUT}=5\Omega$ ,  $C_{OUT} = 10\mu\text{F}(\text{Ceramic})$

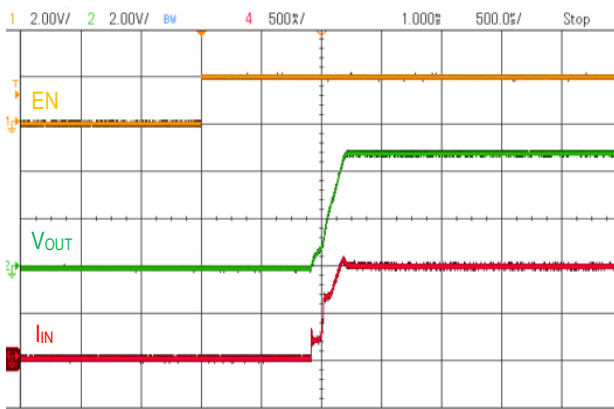

Turn-off Delay and Fall Time,  $V_{IN} = 5\text{V}$ ,  $R_{LIM} = 20\text{k}\Omega$ ,  $R_{OUT}=5\Omega$ ,  $C_{OUT} = 10\mu\text{F}(\text{Ceramic})$

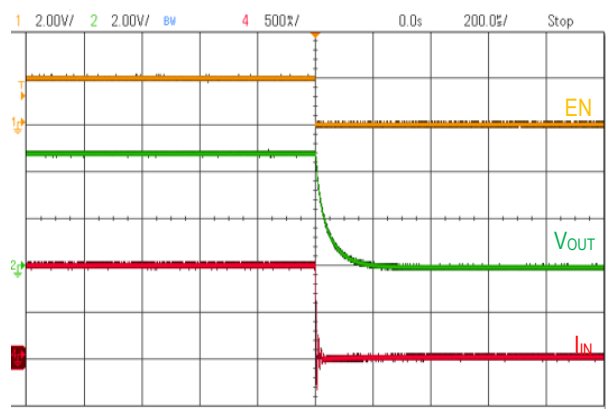

TYPICAL PERFORMANCE CHARACTERISTICS CONT'D

( $T_A=25^{\circ}\text{C}$ , unless otherwise specified)

Device Enabled into short-Circuit,  $V_{IN}=5\text{V}$ ,  
 $R_{LIM}=20\text{k}\Omega$ ,  $R_{OUT}=0\Omega$

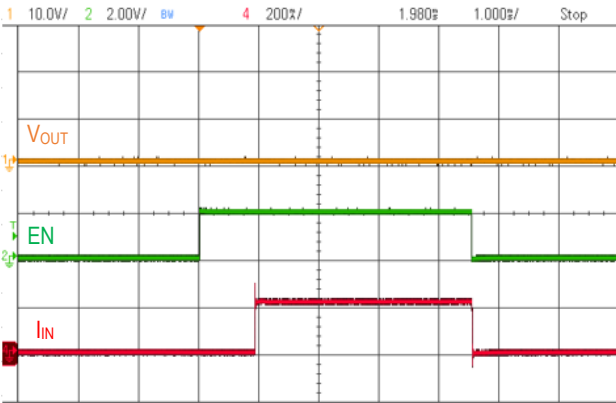

Device Enabled into short-Circuit,  $V_{IN}=5\text{V}$ ,  
 $R_{LIM}=20\text{k}\Omega$ ,  $R_{OUT}=0\Omega$

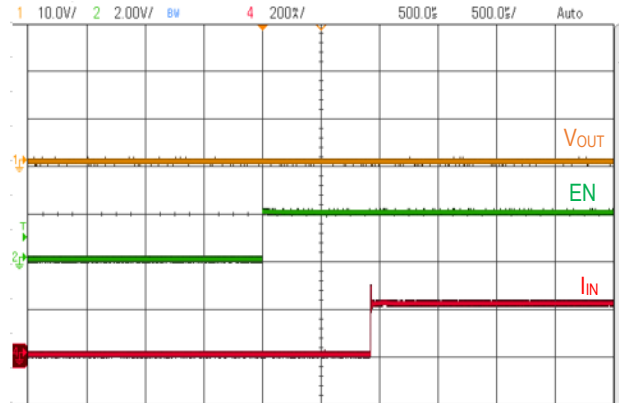

Full Load to Short-Circuit,  $V_{IN}=5\text{V}$ ,  $R_{LIM}=20\text{k}\Omega$

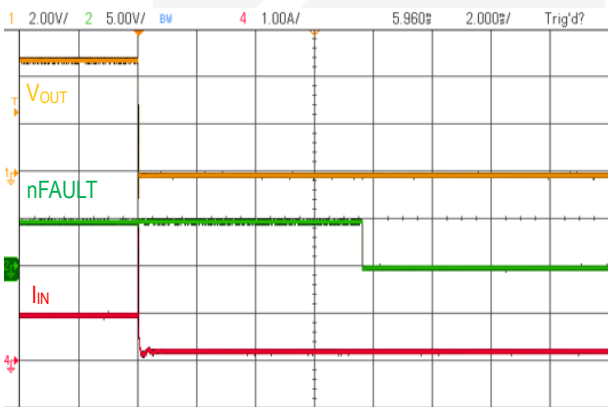

Recovery to full load from short,  $V_{IN}=5\text{V}$ ,  $R_{LIM}=20\text{k}\Omega$

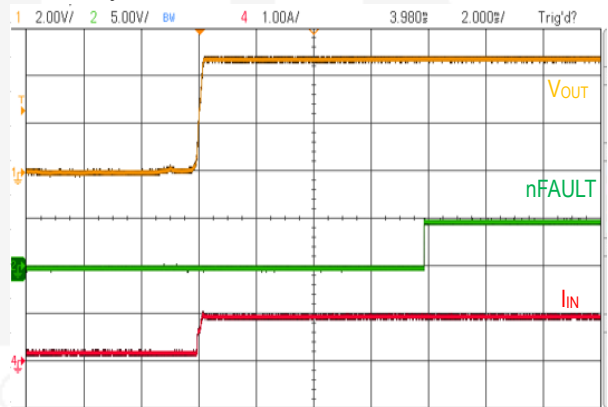

No-load to Short-Circuit,  $V_{IN} = 5\text{V}$ ,  $R_{LIM} = 20\text{k}\Omega$

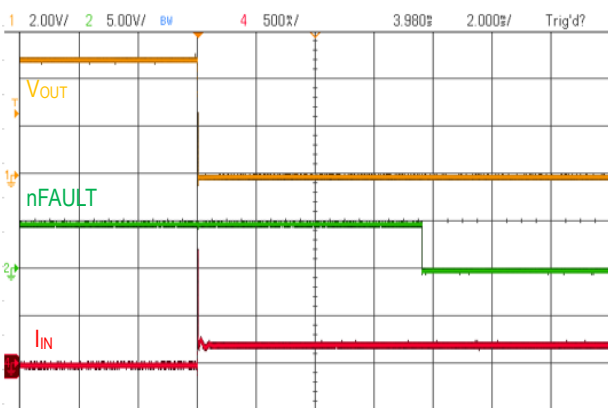

Recovery to No-Load from Short-Circuit,  
 $V_{IN} = 5\text{V}$ ,  $R_{LIM} = 20\text{k}\Omega$

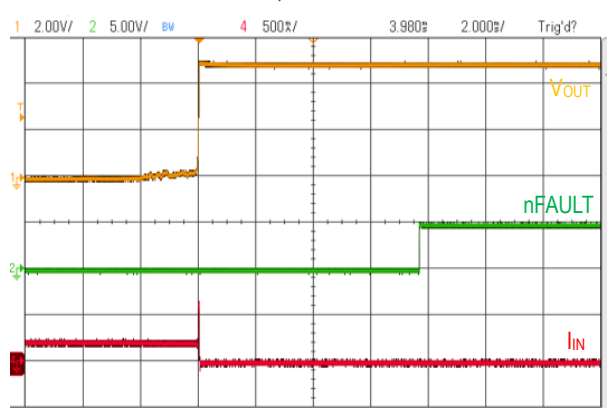

## TYPICAL PERFORMANCE CHARACTERISTICS CONT'D

( $T_A=25^\circ\text{C}$ , unless otherwise specified)

No-load to 1 $\Omega$ -load,  $V_{IN}=5\text{V}$ ,  $R_{ILIM}=20\text{k}\Omega$

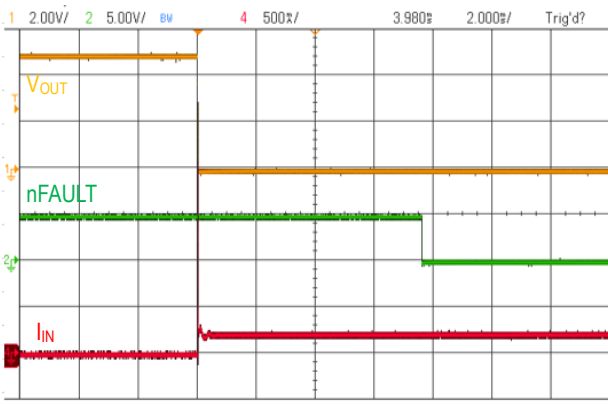

1 $\Omega$ -load to No-load,  $V_{IN}=5\text{V}$ ,  $R_{ILIM}=20\text{k}\Omega$

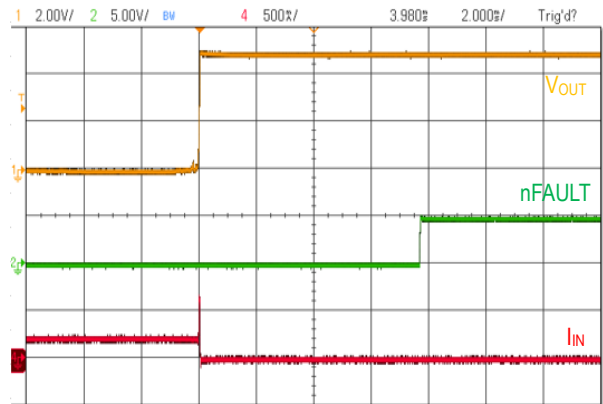

Reverse-Voltage Protection, EN = Logic High

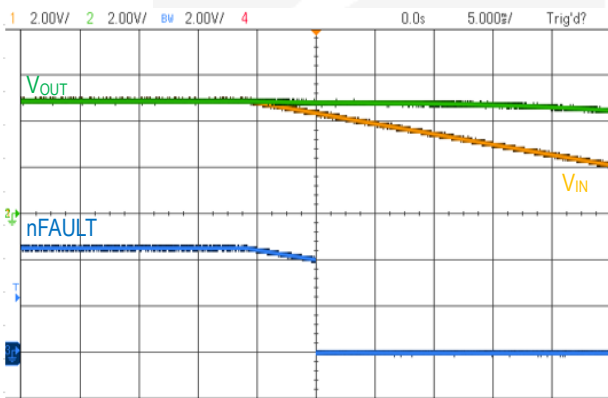

Reverse-Voltage Protection, EN = Logic Low

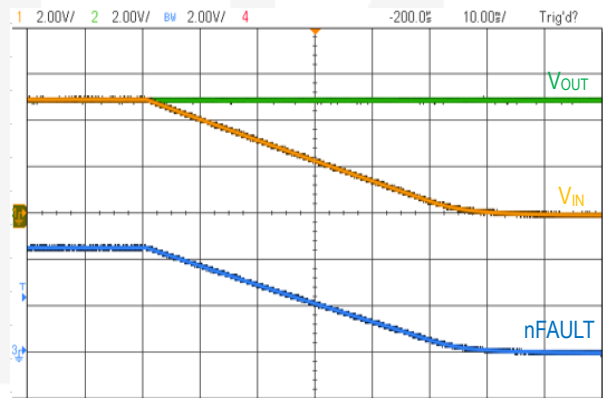

$V_{IN}$  Falls to under nUVLO (no load)

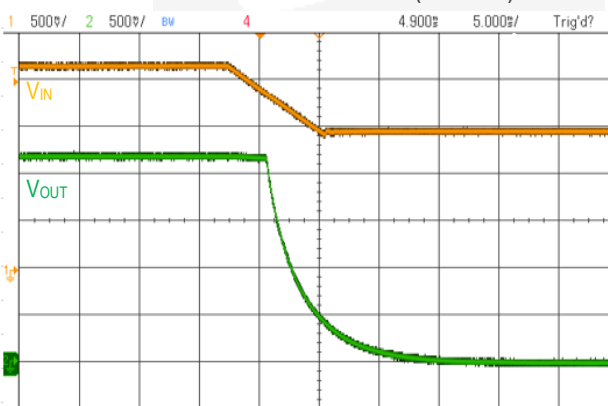

$V_{IN}$  Rises to above nUVLO (no load)

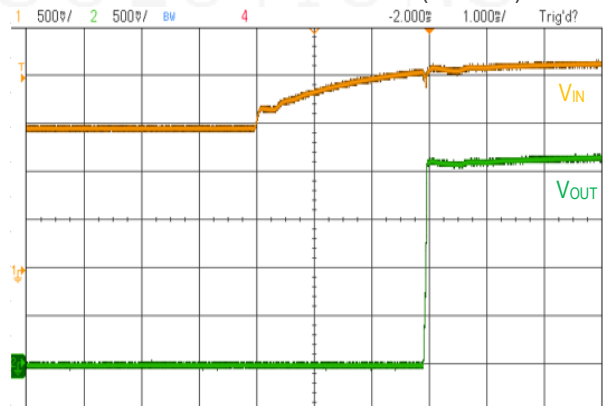

## TYPICAL PERFORMANCE CHARACTERISTICS CONT'D

(T<sub>A</sub>=25°C, unless otherwise specified)

Load Transient, V<sub>IN</sub> = 3V, I<sub>OUT</sub>= 0-1.5A

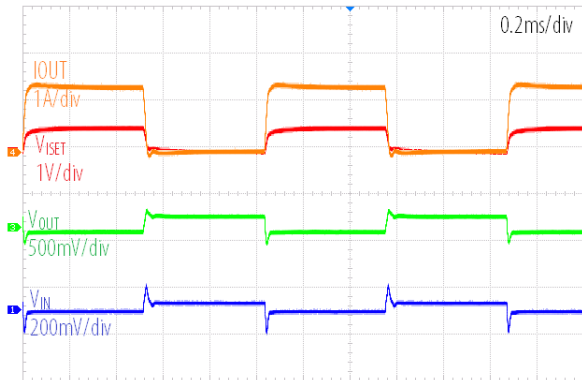

Load Transient, V<sub>IN</sub> = 5.5V, I<sub>OUT</sub>= 0-1.5A

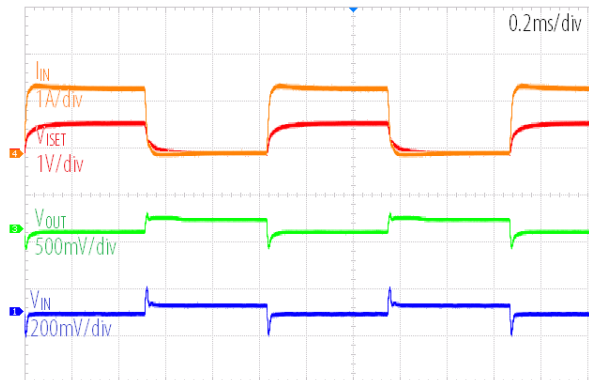

R<sub>on</sub> Vs. Temperature

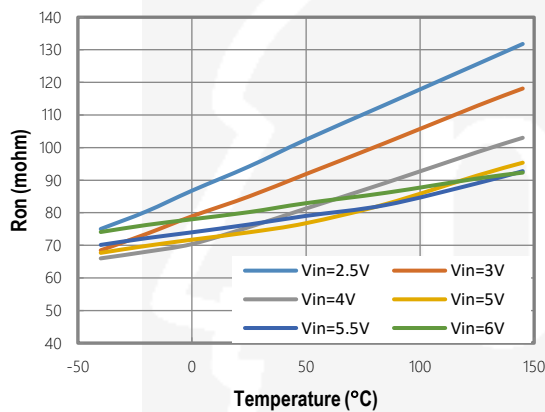

I<sub>limit</sub> Vs R<sub>limit</sub>

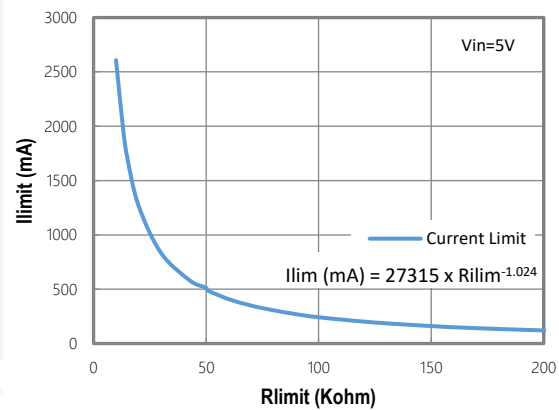

## FUNCTION DESCRIPTION

The ETA6027 is a load switch which provides full protection to systems and loads which may encounter large current conditions. ETA6027 offers a 70mΩ current-limited switch which can operate over an input voltage range of 2.1-6V. The current limit can be externally programmed by a precision resistor, ranges from 75mA to 2.2A. ETA6027 also features reverse voltage blocking, UVLO, and thermal shutdown to protect IC from overheating. An nFAULT flag output provides a pull-down signal to indicate fault conditions.

### CURRENT LIMITING

The current limit ensures that the current through the switch doesn't exceed a maximum value while not limiting at less than a minimum value. The current at which the parts will limit is adjustable through the selection of an external resistor connected to ILIM.



RILIM (KΩ)	Typical Current Limit (mA)
200	138
180	152
151	179
100	266
82	324
68	389
51	520
43	612
30	873
20	1295
15.1	1705

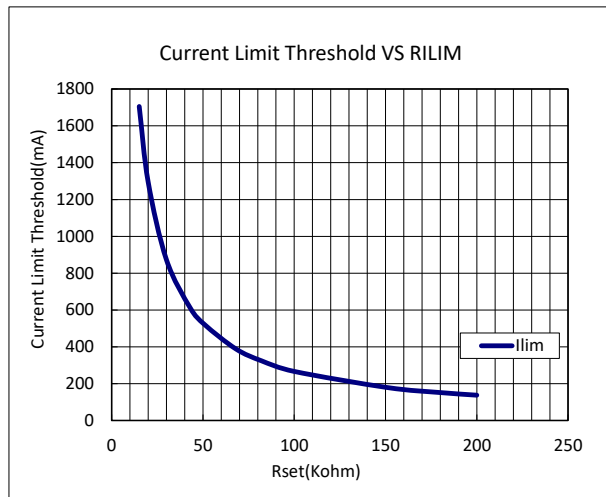

ETA6027's thermal shutdown cycles if an overload condition is present long enough to activate thermal limiting in any of the above cases. The device turns off when the junction temperature exceeds 135°C (typically) while in current limit. The device remains off until the junction temperature cools 10°C (typically) and then restarts

### IN-OUT FORWARD VOLTAGE REGULATION and REVERSE-VOLTAGE BLOCKING

ETA6027 is integrated an advanced technology to get a perfect reverse protection function. When Output current is high enough, the different voltage between IN and OUT terminals is determined by  $I_{OUT} * R_{ON}$ . But when output current is low, OUT is regulated to be always lower than IN a small difference, VFW. This will control VGS of Power MOSFET small enough to handle output current with its VDS not changed. And finally, there is not any reverse current at any condition since Power MOSFET will be in Cutoff when output current reaches zero.

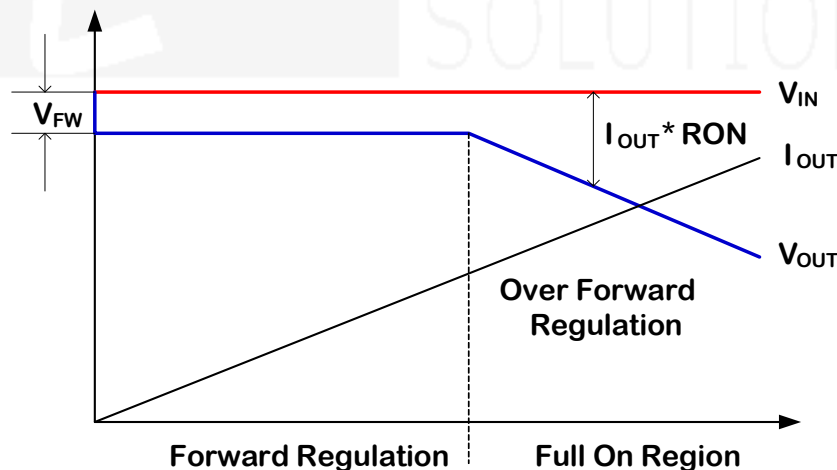

This prevents damage to devices on the input side of the ETA6027 by preventing significant current from sinking into the input capacitance.

The nFAULT pin will not indicate the reverse condition until output voltage exceeds the input voltage by 150mV (typically) for TF\_REV=4.5ms (typically).

## *nFAULT FLAG*

The nFAULT open-drain output is asserted (active low) during an over-current, over temperature or reverse-voltage condition. The ETA6027 asserts the FAULT signal until the fault condition is removed and the device resumes normal operation. The nFAULT signal is de-asserted once device power is cycled or the enable is toggled and the device resumes normal operation. The ETA6027 is designed to eliminate false nFAULT reporting by using an internal delay "deglitch" circuit for over-current (9-ms typically) and reverse-voltage (4.5-ms typically) conditions without the need for external circuitry. This ensures that nFAULT is not accidentally asserted due to normal operation such as starting into a heavy capacitive load. The deglitching circuitry delays entering and leaving fault conditions. Over temperature conditions are not deglitched and assert the nFAULT signal immediately.

## APPLICATION INFORMATION

### *INPUT OUTPUT CAPACITANCE*

Input and output capacitance improve the performance of the device; the actual capacitance should be optimized for the particular application. For all applications, a 4.7 $\mu$ F or greater ceramic bypass capacitor between IN and GND is recommended as close to the device as possible for local noise de-coupling. This precaution reduces ringing on the input due to power-supply transients. Additional input capacitance may be needed on the input to reduce voltage overshoot from exceeding the absolute maximum voltage of the device during heavy transient conditions. This is especially important during bench testing when long, inductive cables are used to connect the evaluation board to the bench power-supply. Placing a high-value electrolytic capacitor on the output pin is recommended when large transient currents are expected on the output.

### *POWER DISSIPATION*

During normal operation as a switch, the power dissipated in the part will depend upon the level at which the current limit is set. The maximum allowed setting for the current limit is 2A and this will result in a power dissipation of,

$$P=(ILIM)^2 \times R_{ON} = 2^2 \times 0.09 = 360\text{mW}$$

assuming the part is in high temperature, the Ron increases to 90mohm.

If the part goes into current limit the maximum power dissipation will occur when the output is shorted to 1V above ground. This is more power than the package can dissipate, but the thermal shutdown of the part will activate to protect the part from damage due to excessive heating. A short on the output will cause the part to operate in a constant current state, dissipating a worst-case power of

$$P_{(MAX)} = [VIN(max) - 1] \times ILIM(max) = (6.1 - 1) \times 2 = 9\text{W}$$

This large amount of power will activate the thermal shutdown and the part will cycle in and out of thermal shutdown so long as the ON pin is active and the short is present.

## PCB LAYOUT GUIDE

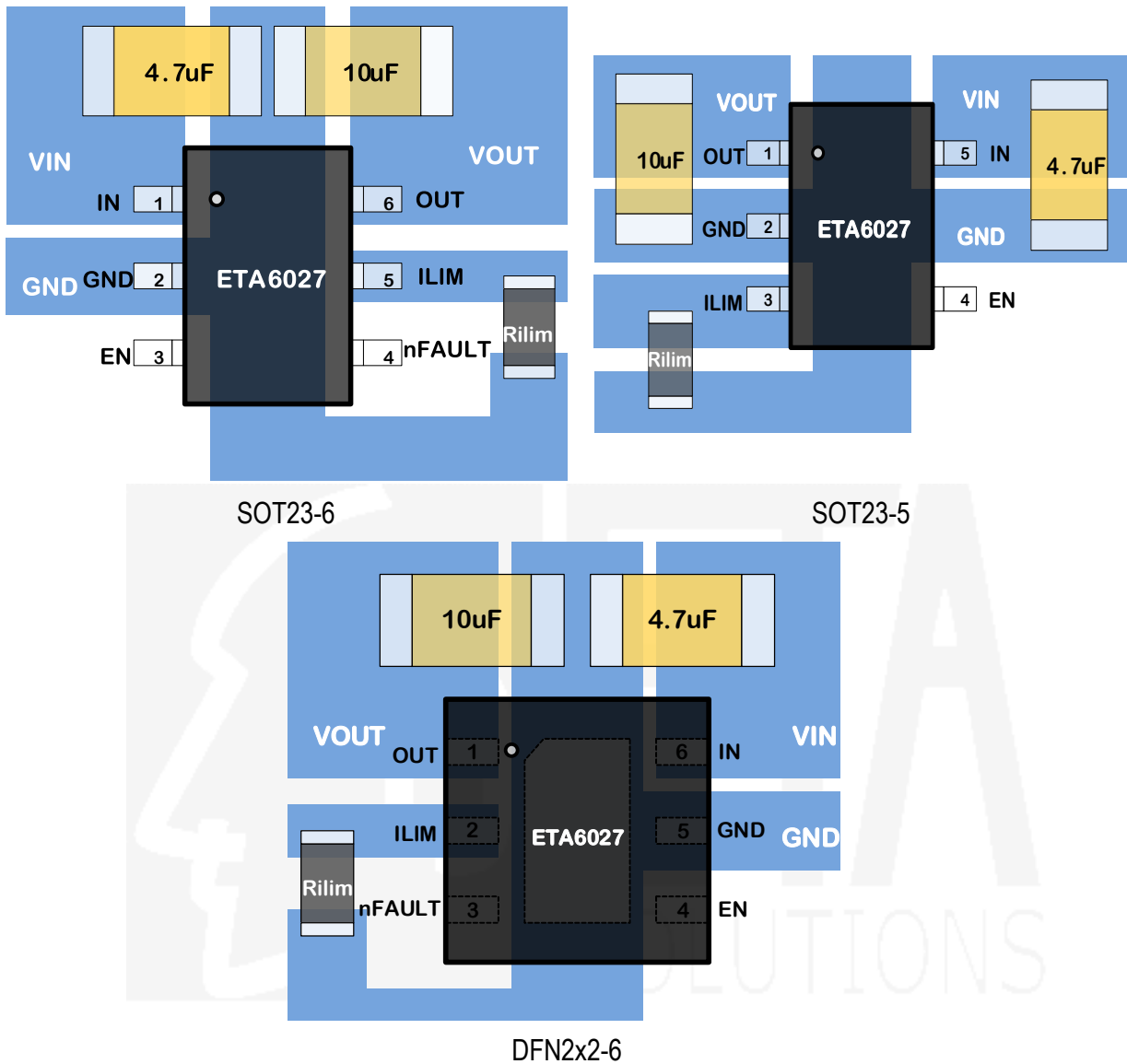

## PACKAGE OUTLINE

Package: SOT23-6

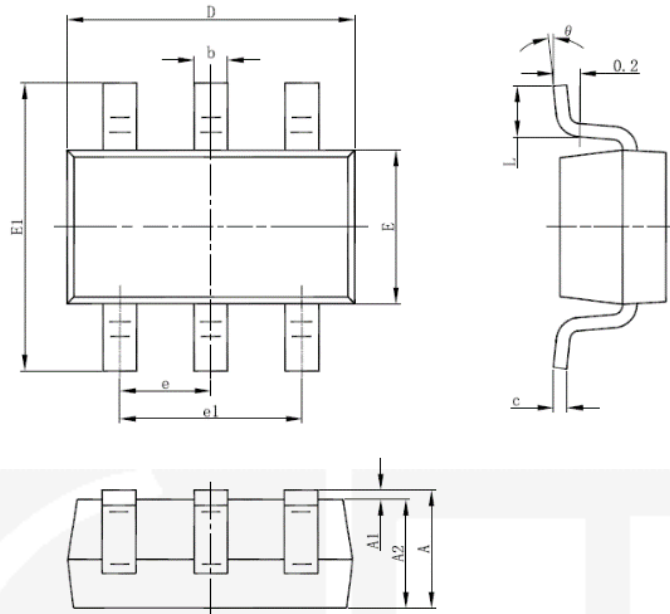

Symbol	Dimensions In Millimeters		Dimensions In Inches	
	Min	Max	Min	Max
A	1.050	1.250	0.041	0.049
A1	0.000	0.100	0.000	0.004
A2	1.050	1.150	0.041	0.045
b	0.300	0.500	0.012	0.020
c	0.100	0.200	0.004	0.008
D	2.820	3.020	0.111	0.119
E	1.500	1.700	0.059	0.067
E1	2.650	2.950	0.104	0.116
e	0.950(BSC)		0.037(BSC)	
e1	1.800	2.000	0.071	0.079
L	0.300	0.600	0.012	0.024
θ	0°	8°	0°	8°

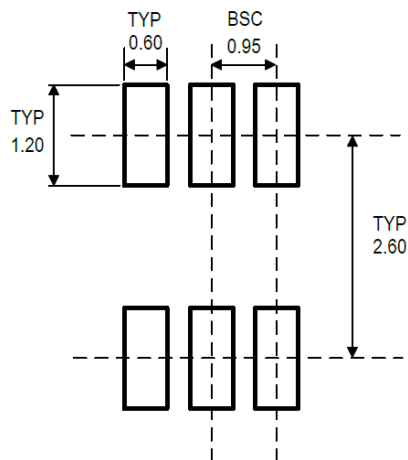

RECOMMENDED LAND PATTERN

Package: SOT23-5

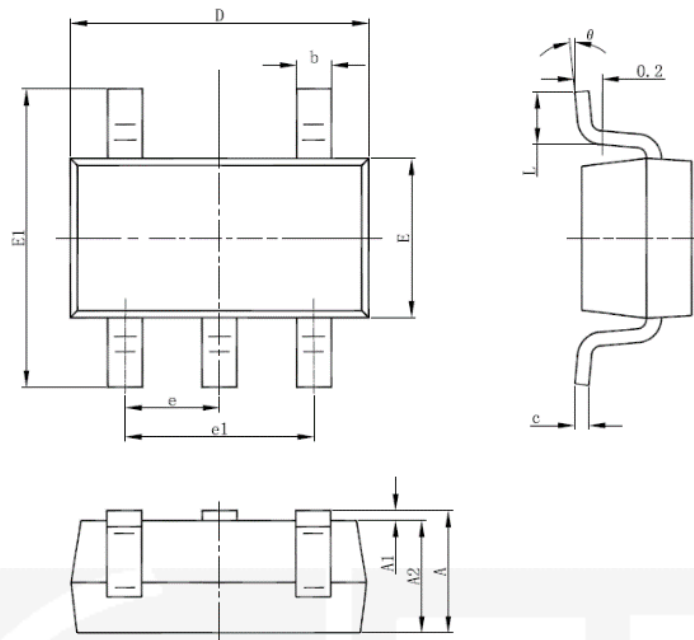

Symbol	Dimensions In Millimeters		Dimensions In Inches	
	Min	Max	Min	Max
A	1.050	1.250	0.041	0.049
A1	0.000	0.100	0.000	0.004
A2	1.050	1.150	0.041	0.045
b	0.300	0.500	0.012	0.020
c	0.100	0.200	0.004	0.008
D	2.820	3.020	0.111	0.119
E	1.500	1.700	0.059	0.067
E1	2.650	2.950	0.104	0.116
e	0.950(BSC)		0.037(BSC)	
e1	1.800	2.000	0.071	0.079
L	0.300	0.600	0.012	0.024
theta	0°	8°	0°	8°

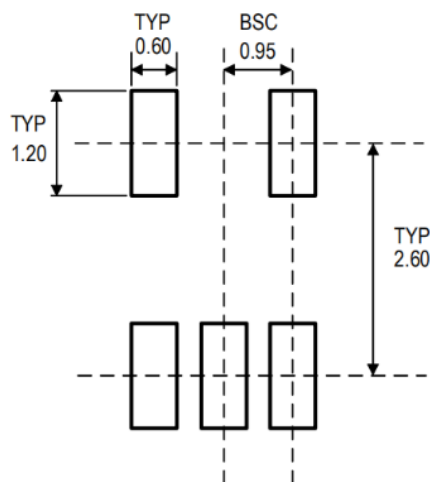

RECOMMENDED LAND PATTERN

Package: DFN2x2-6  
From assembly house 1:

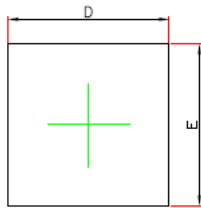

TOP VIEW

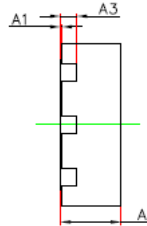

SIDE VIEW

Symbol	Dimensions In Millimeters		Dimensions In Inches	
	Min.	Max.	Min.	Max.
A	0.700	0.800	0.028	0.031
A1	0.000	0.050	0.000	0.002
A3	0.203REF.		0.008REF.	
D	1.900	2.100	0.075	0.083
E	1.900	2.100	0.075	0.083
D1	0.900	1.100	0.035	0.043
E1	1.500	1.700	0.059	0.067
k	0.250 REF.		0.010REF.	
b	0.250	0.350	0.010	0.014
b1	0.220 REF.		0.009 REF.	
e	0.650BSC.		0.026BSC.	
L	0.174	0.326	0.007	0.013

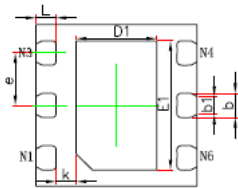

From assembly house 2:

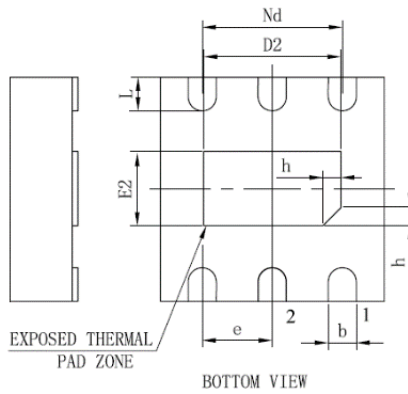
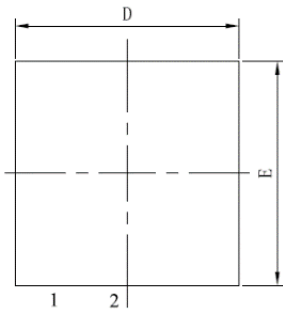

EXPOSED THERMAL PAD ZONE

BOTTOM VIEW

SYMBOL	MILLIMETER		
	MIN	NOM	MAX
A	0.70	0.75	0.80
A1	—	0.02	0.05
b	0.25	0.30	0.35
c	0.18	0.20	0.25
D	1.95	2.00	2.05
D2	1.00	1.23	1.45
e	0.65BSC		
Nd	1.30BSC		
E	1.95	2.00	2.05
E2	0.50	0.68	0.85
L	0.25	0.30	0.40
h	0.10	0.15	0.20

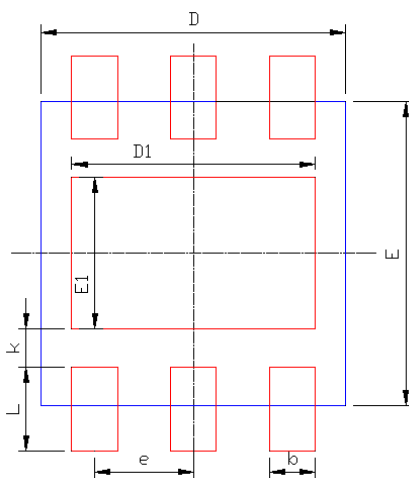
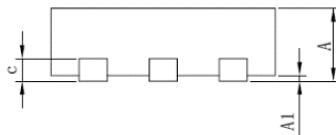

RECOMMENDED LAND PATTERN

Dimensions	Value (in mm)
D	2
E	2
D1	1.6
E1	1
e	0.65
b	0.3
L	0.55
K	0.25 (at least 0.2)

## TAPE AND REEL INFORMATION

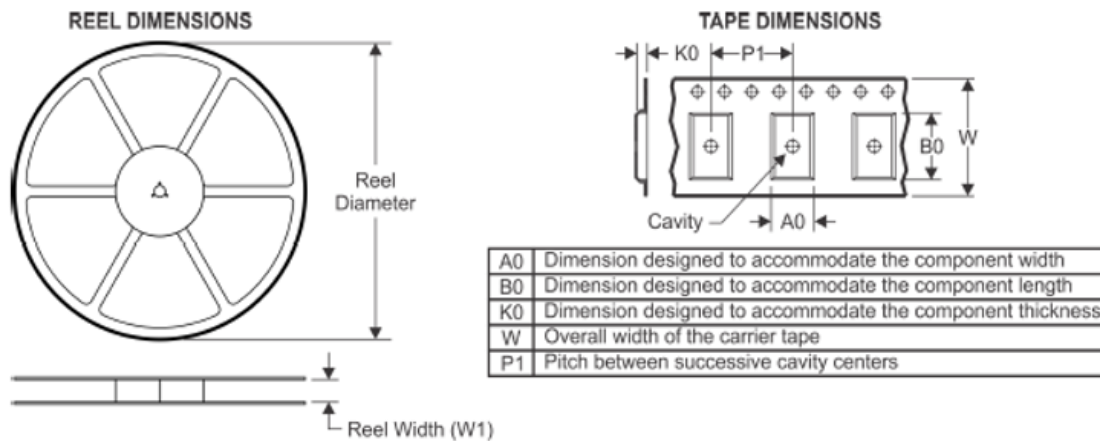

### QUADRANT ASSIGNMENTS FOR PIN 1 ORIENTATION IN TAPE

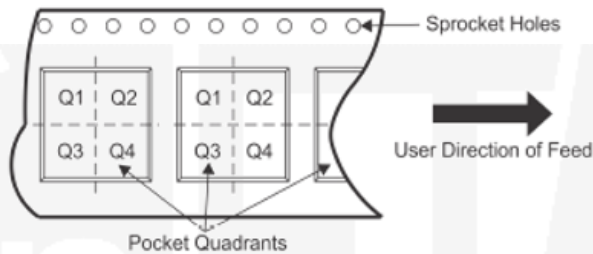

Device	Package Type	Pins	SPQ	Reel Diameter (mm)	Reel Width W1 (mm)	A0 (mm)	B0 (mm)	K0 (mm)	P1 (mm)	W (mm)	Pin1 Quadrant
ETA6027S2G	SOT23-6	6	3000	180	9.5	3.17	3.23	1.37	4	8	Q3
ETA6027S2F	SOT23-5	5	3000	180	9.5	3.17	3.23	1.37	4	8	Q3
ETA6027D2I	DFN2x2-6	6	3000	180	9.5	2.3	2.3	1.1	4	8	Q1

## X-ON Electronics

Largest Supplier of Electrical and Electronic Components

*Click to view similar products for* [Power Switch ICs - Power Distribution](#) *category:*

*Click to view products by* [etasolution](#) *manufacturer:*

Other Similar products are found below :

[TLE6232GP](#) [NCP45520IMNTWG-L](#) [VND5E004ATR-E](#) [FPF1018](#) [DS1222](#) [NCV380HMUAJAATBG](#) [SZNCP3712ASNT3G](#)  
[NCP45520IMNTWG-H](#) [VND5004ATR-E](#) [AP22811BW5-7](#) [SLG5NT1437VTR](#) [SZNCP3712ASNT1G](#) [DML1008LDS-7](#) [TS13011-QFNR](#)  
[VND7012AYTR](#) [NCV459MNWTBG](#) [NCP4545IMNTWG-L](#) [NCV8412ASTT1G](#) [NCV8412ASTT3G](#) [FPF2260ATMX](#) [SLG5NT1765V](#)  
[SLG5NT1757V](#) [NCP45780IMN24RTWG](#) [AP2151DMPG-13](#) [AP2151AMP-13](#) [NCP45540IMNTWG-L](#) [TPS2022P](#) [FPF2495BUCX](#)  
[NCP45650IMNTWG](#) [NCV8412ADDR2G](#) [DK5V100R20S](#) [BTS7020-2EPA](#) [BTT6100-2ERA](#) [BTS71220-4ESA](#) [DK5V100R15M](#)  
[WS3220C9-9/TR](#) [BTT6030-2ERA](#) [TLE75602-ESH](#) [BTS5200-4EKA](#) [DK5V150R25M](#) [DK5V45R25](#) [DK5V100R25S](#) [AW35206FOR](#)  
[BTS7120-2EPA](#) [TLE75008-ESD](#) [BTS7040-1EPA](#) [BTT6030-1ERA](#) [DK5V60R10S](#) [DK5V45R25S](#) [DK5V60R10](#)