

Dual N-Channel High Density Trench MOSFET (20V, 6A)

PRODUCT SUMMARY

| | | |
|-----------|-------|---------------------------------|
| V_{DSS} | I_D | $R_{DS(on)}$ (m Ω) Typ. |
| 20V | 6.0A | 19 @ $V_{GS} = 4.5V, I_D=6A$ |
| | | 20 @ $V_{GS} = 4.0V, I_D=6A$ |
| | | 25 @ $V_{GS} = 2.5V, I_D=5.2A$ |

Features

- Advanced Trench Process Technology
- High Density Cell Design for Ultra Low On-Resistance
- Surface mount Package
- Lead (Pb) -free and halogen-free

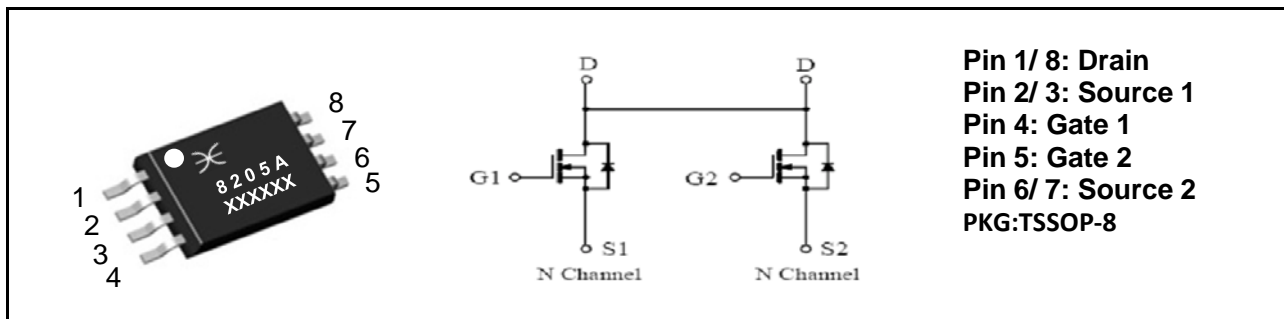

Absolute Maximum Ratings ($T_A=25^\circ C$, unless otherwise noted)

| Symbol | Parameter | Ratings | Units |
|----------------|---|-------------|--------------|
| V_{DS} | Drain-Source Voltage | 20 | V |
| V_{GS} | Gate-Source Voltage | ± 12 | V |
| I_D | Drain Current (Continuous) | 6 | A |
| I_{DM} | Drain Current (Pulsed) ^a | 20 | A |
| P_D | Total Power Dissipation @ $T_A=25^\circ C$ | 2 | W |
| I_S | Maximum Diode Forward Current | 1.7 | A |
| T_j, T_{stg} | Operating Junction and Storage Temperature Range | -55 to +150 | $^\circ C$ |
| R_{QJA} | Thermal Resistance Junction to Ambient (PCB mounted) ^b | 62 | $^\circ C/W$ |

a: Repetitive Rating: Pulse width limited by the maximum junction temperature.

b: 1-in² 2oz Cu PCB board

Electrical Characteristics (T_A=25°C, unless otherwise noted)

| Symbol | Characteristic | Test Conditions | Min. | Typ. | Max. | Unit |
|---|------------------------------------|---|------|------|------|------|
| • Off Characteristics | | | | | | |
| BV _{DSS} | Drain-Source Breakdown Voltage | V _{GS} =0V, I _D =250uA | 20 | - | - | V |
| I _{DSS} | Zero Gate Voltage Drain Current | V _{DS} =20V, V _{GS} =0V | - | - | 1 | μA |
| I _{GSS} | Gate-Body Leakage Current | V _{GS} =±12V, V _{DS} =0V | - | - | ±10 | μA |
| • On Characteristics | | | | | | |
| V _{GS(th)} | Gate Threshold Voltage | V _{DS} =V _{GS} , I _D =250uA | 0.5 | 0.65 | 1.0 | V |
| R _{DS(on)} | Drain-Source On-State Resistance | V _{GS} =4.5V, I _D =6A | - | 19 | 24 | mΩ |
| | | V _{GS} =3V, I _D =5.2A | - | 20 | 27 | |
| | | V _{GS} =2.5V, I _D =5.2A | - | 25 | 28 | |
| • Dynamic Characteristics | | | | | | |
| C _{iss} | Input Capacitance | V _{DS} =6V, V _{GS} =0V, f=1MHz | - | 559 | - | PF |
| C _{oss} | Output Capacitance | | - | 148 | - | |
| C _{rss} | Reverse Transfer Capacitance | | - | 127 | - | |
| • Switching Characteristics | | | | | | |
| Q _g | Total Gate Charge | V _{DS} =10V, I _D =6A, V _{GS} =4.5V | - | 5 | - | nC |
| Q _{gs} | Gate-Source Charge | | - | 0.9 | - | |
| Q _{gd} | Gate-Drain Charge | | - | 1.4 | - | |
| t _{d(on)} | Turn-on Delay Time | V _{DD} =10V, R _L =1.2Ω, I _D =1A, V _{GEN} =10V, R _G =6Ω | - | 10.2 | - | nS |
| t _r | Turn-on Rise Time | | - | 7 | - | |
| t _{d(off)} | Turn-off Delay Time | | - | 33 | - | |
| t _f | Turn-off Fall Time | | - | 6.8 | - | |
| • Drain-Source Diode Characteristics | | | | | | |
| V _{SD} | Drain-Source Diode Forward Voltage | V _{GS} =0V, I _S =1.7A | - | - | 1.2 | V |

Note: Pulse Test: Pulse Width ≤ 300us, Duty Cycle ≤ 2%

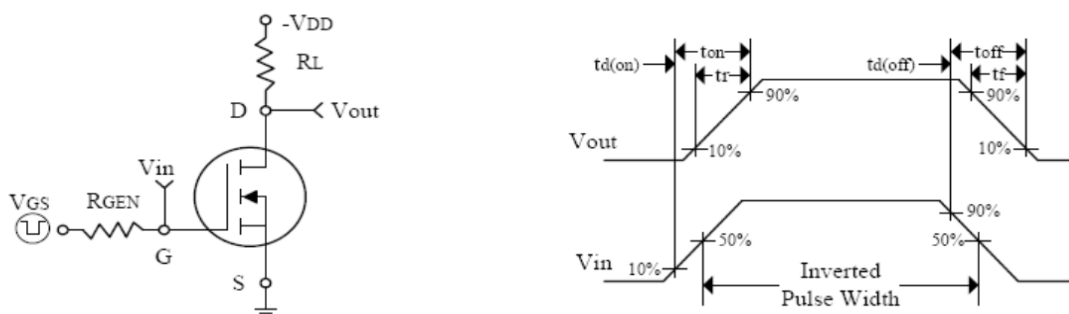

Switching Test Circuit and Switching Waveforms

Typical Characteristics Curves (Ta=25°C, unless otherwise note)

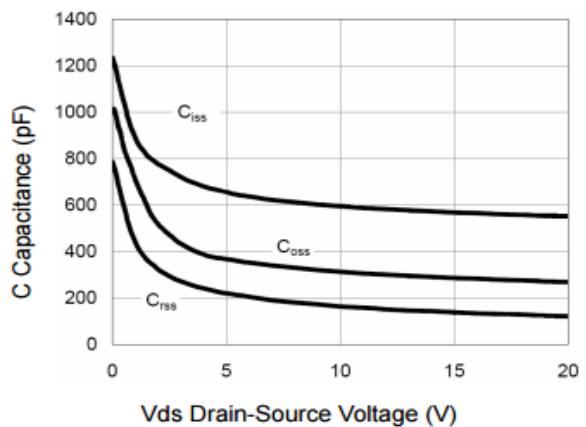
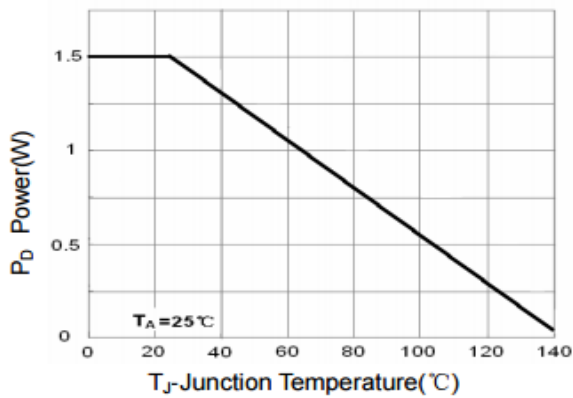
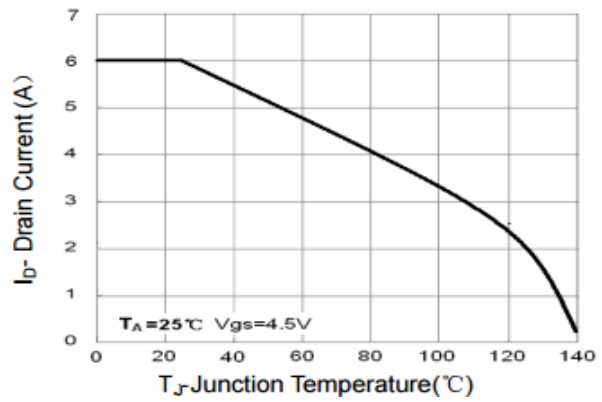
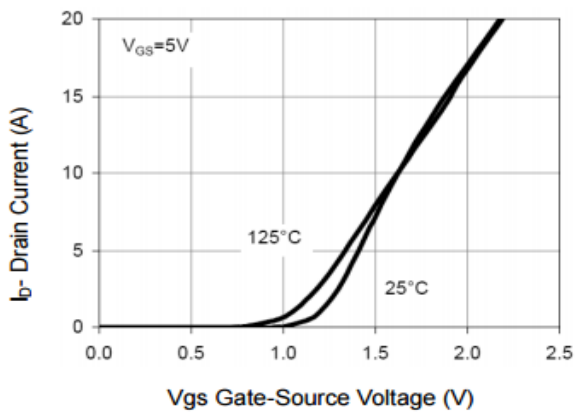
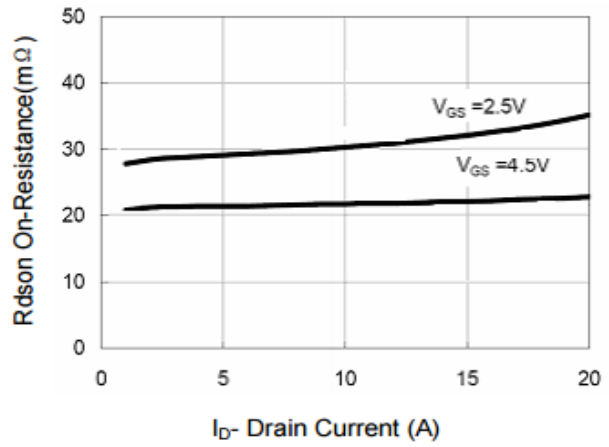
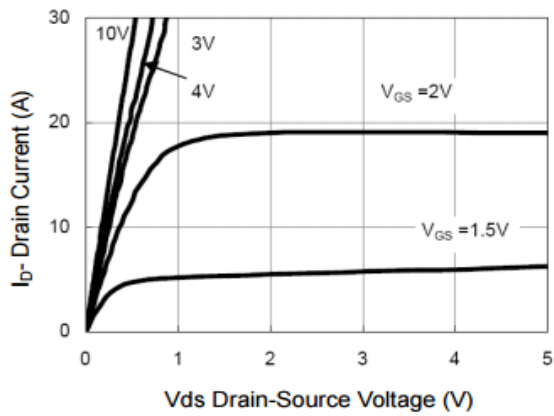

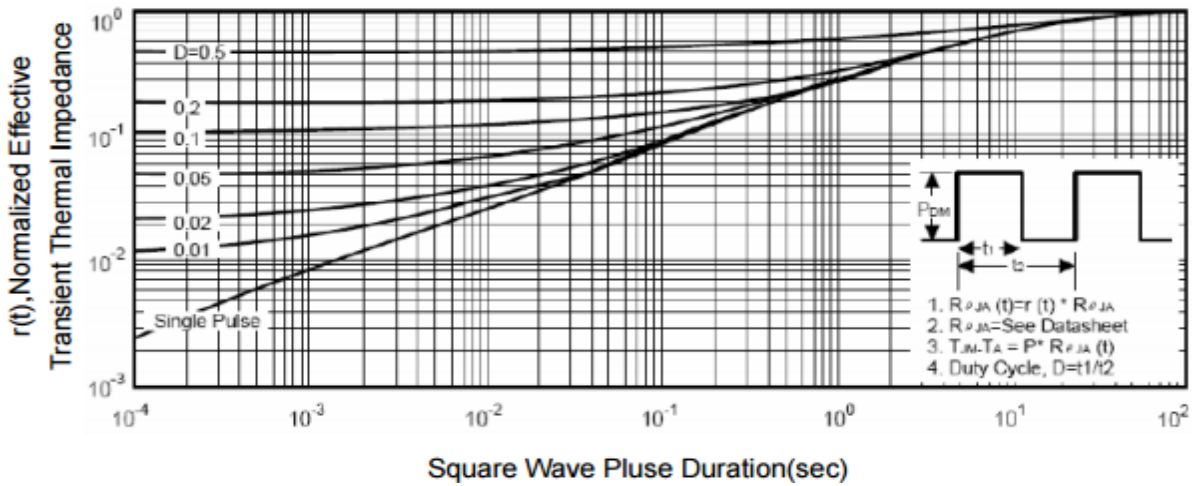
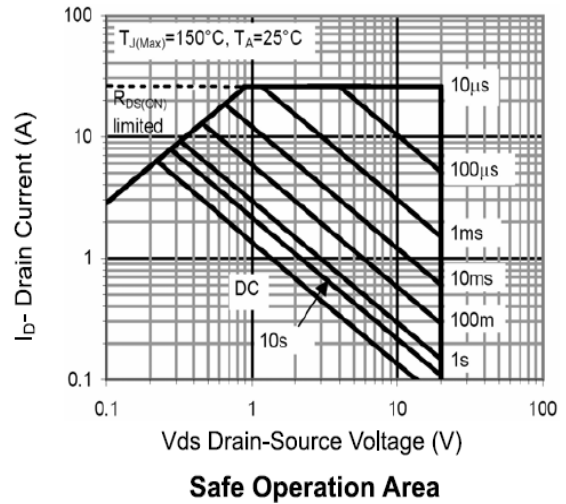
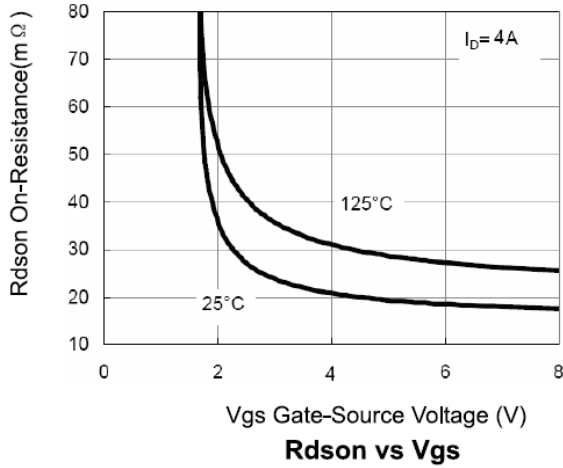
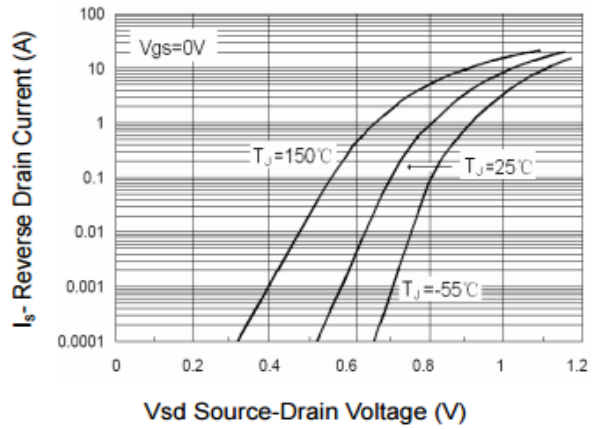
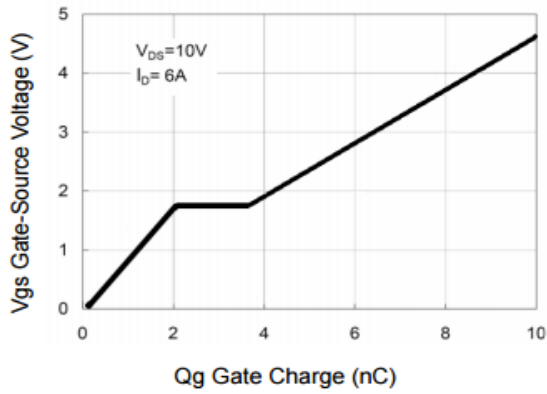

TSSOP8 PACKAGE OUTLINE DIMENSIONS

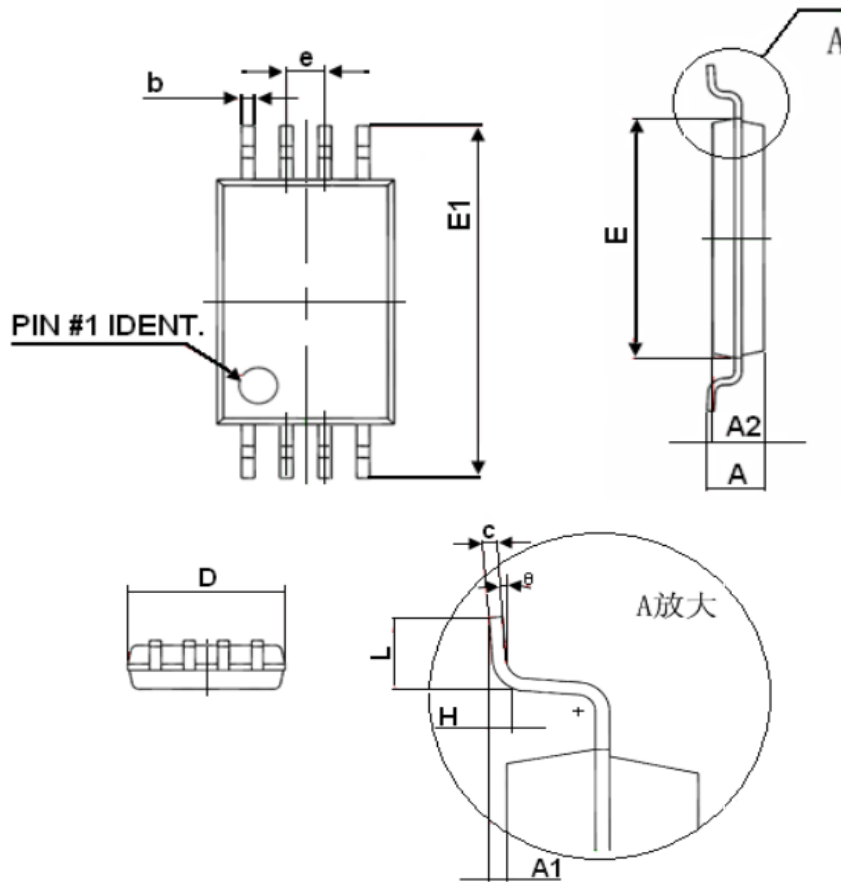

| Symbol | Dimensions In Millimeters | |
|--------|---------------------------|-------|
| | Min | Max |
| D | 2.900 | 3.100 |
| E | 4.300 | 4.500 |
| b | 0.190 | 0.300 |
| c | 0.090 | 0.200 |
| E1 | 6.250 | 6.550 |
| A | | 1.100 |
| A2 | 0.800 | 1.000 |
| A1 | 0.020 | 0.150 |
| e | 0.65(BSC) | |
| L | 0.500 | 0.700 |
| H | 0.25(TYP) | |
| Θ | 1° | 7° |

X-ON Electronics

Largest Supplier of Electrical and Electronic Components

Click to view similar products for [MOSFET](#) category:

Click to view products by [Eternal Semiconductor](#) manufacturer:

Other Similar products are found below :

[614233C](#) [648584F](#) [MCH3443-TL-E](#) [MCH6422-TL-E](#) [FDPF9N50NZ](#) [NTNS3A92PZT5G](#) [IRFD120](#) [IRFF430](#) [JANTX2N5237](#) [2N7000](#)
[AOD464](#) [2SK2267\(Q\)](#) [2SK2545\(Q,T\)](#) [405094E](#) [423220D](#) [MIC4420CM-TR](#) [VN1206L](#) [614234A](#) [715780A](#) [751625C](#)
[IPS70R2K0CEAKMA1](#) [BSF024N03LT3 G](#) [PSMN4R2-30MLD](#) [TK31J60W5,S1VQ\(O](#) [2SK2614\(TE16L1,Q\)](#) [DMN1017UCP3-7](#)
[EFC2J004NUZTDG](#) [FCAB21350L1](#) [P85W28HP2F-7071](#) [DMN1053UCP4-7](#) [NTE2384](#) [NTE2969](#) [NTE6400A](#) [DMC2700UDMQ-7](#)
[DMN2080UCB4-7](#) [DMN61D9UWQ-13](#) [US6M2GTR](#) [DMN31D5UDJ-7](#) [SSM6P54TU,LF](#) [DMP22D4UFO-7B](#) [IPS60R3K4CEAKMA1](#)
[DMN1006UCA6-7](#) [DMN16M9UCA6-7](#) [STF5N65M6](#) [IRF40H233XTMA1](#) [IPSA70R950CEAKMA1](#) [IPSA70R2K0CEAKMA1](#) [STU5N65M6](#)
[C3M0021120D](#) [DMN6022SSD-13](#)