



N-Channel Enhancement-Mode MOSFET (30V, 5.8A)

PRODUCT SUMMARY

V_{DSS}	I_D	$R_{DS(on)}$ (m Ω) Typ.
30V	5.8A	23@ $V_{GS} = 10V, I_D = 5.8A$
		25@ $V_{GS} = 4.5V, I_D = 5.0A$
		30@ $V_{GS} = 2.5V, I_D = 4.0A$

Features

- Super high dense cell trench design for low $R_{DS(on)}$
- Rugged and reliable
- SOT-23-3L package
- Lead (Pb) -free and halogen-free

	<p>EV3400 Pin Assignment & Symbol 3-Lead Plastic SOT-23-3L Pin 1: Gate Pin 2: Source Pin3: Drain</p>	
--	--	--

Absolute Maximum Ratings ($T_A = 25^\circ\text{C}$, unless otherwise noted)

Symbol	Parameter	Rated	Units
V_{DS}	Drain-Source Voltage	30	V
V_{GS}	Gate-Source Voltage	± 12	V
I_D	Drain Current (Continuous)	5.8	A
I_{DM}	Drain Current (Pulsed) ^a	24	A
P_D	Total Power Dissipation @ $T_A = 25^\circ\text{C}$	1.4	W
T_j, T_{stg}	Operating Junction and Storage Temperature Range	-55 to +150	$^\circ\text{C}$
R_{QJA}	Thermal Resistance Junction to Ambient (PCB mounted) ^b	100	$^\circ\text{C/W}$

a: Repetitive Rating: Pulse width limited by the maximum junction temperature.

b: 1-in² 2oz Cu PCB board

Electrical Characteristics (T_A=25°C, unless otherwise noted)

Symbol	Characteristic	Test Conditions	Min.	Typ.	Max.	Unit
• Off Characteristics						
BV _{DSS}	Drain-Source Breakdown Voltage	V _{GS} =0V, I _D =-250uA	30	-	-	V
I _{DSS}	Zero Gate Voltage Drain Current	V _{DS} =30V, V _{GS} =0V	-	-	1	μA
I _{GSS}	Gate-Body Leakage Current	V _{GS} =±20V, V _{DS} =0V	-	-	±100	nA
• On Characteristics						
V _{GS(th)}	Gate Threshold Voltage	V _{DS} =V _{GS} , I _D =-250uA	1	0.85	2	V
R _{DS(on)}	Drain-Source On-State Resistance	V _{GS} =10V, I _D =5.8A	-	23	29	mΩ
		V _{GS} =4.5V, I _D =5A		25	31	
		V _{GS} =2.5V, I _D =4A		30	42	
• Dynamic Characteristics						
C _{iss}	Input Capacitance	V _{DS} =15V, V _{GS} =0V, f=1MHz	-	560	-	PF
C _{oss}	Output Capacitance		-	58	-	
C _{rss}	Reverse Transfer Capacitance		-	47	-	
• Switching Characteristics						
Q _g	Total Gate Charge	V _{DS} =15V, I _D =5A, V _{GS} =10V	-	5.2	-	nC
Q _{gs}	Gate-Source Charge		-	0.9	-	
Q _{gd}	Gate-Drain Charge		-	1.6	-	
t _{d(on)}	Turn-on Delay Time	V _{DD} =15V, R _L =3Ω, I _D =1A, V _{GEN} =4.5V, R _G =3Ω	-	5	-	nS
t _r	Turn-on Rise Time		-	3	-	
t _{d(off)}	Turn-off Delay Time		-	16	-	
t _f	Turn-off Fall Time		-	4	-	
• Drain-Source Diode Characteristics						
V _{SD}	Drain-Source Diode Forward Voltage	V _{GS} =0V, I _S =-1A	-	-	-1	V

Note: Pulse Test: Pulse Width ≤ 300us, Duty Cycle ≤ 2%

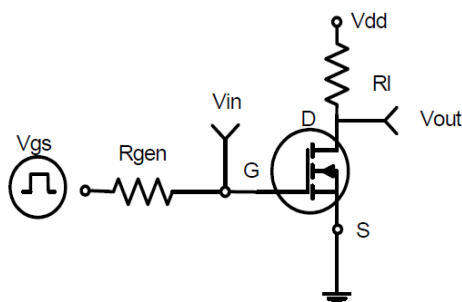

Switching Test Circuit

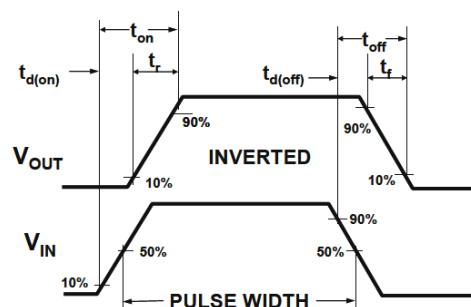

Switching Waveforms

Typical Characteristics Curves (Ta=25°C, unless otherwise note)

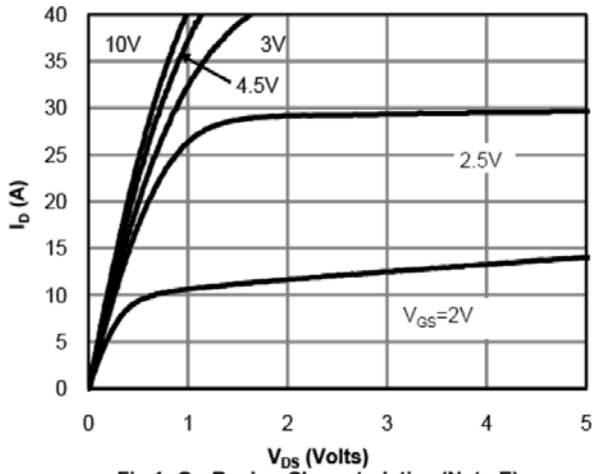

Fig 1: On-Region Characteristics (Note E)

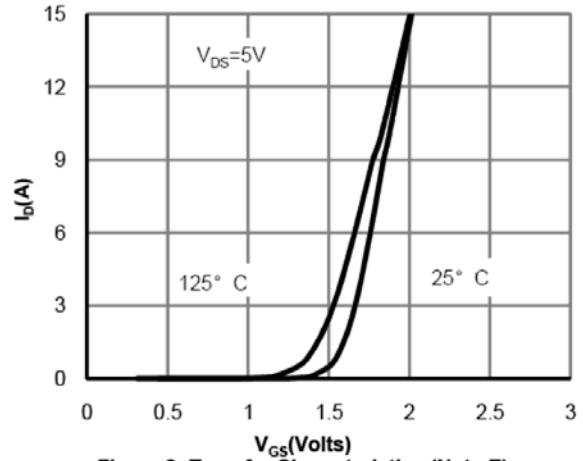

Figure 2: Transfer Characteristics (Note E)

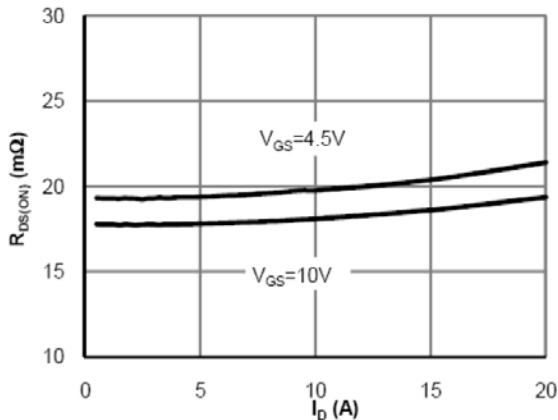

Figure 3: On-Resistance vs. Drain Current and Gate Voltage (Note E)

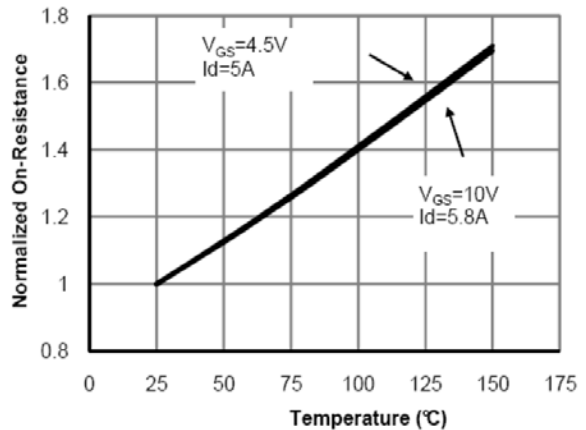

Figure 4: On-Resistance vs. Junction Temperature (Note E)

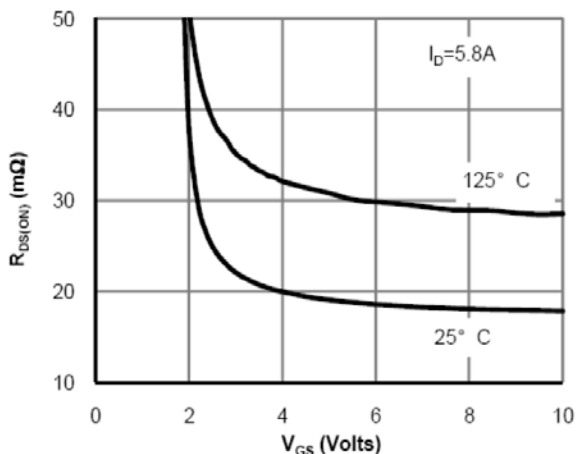

Figure 5: On-Resistance vs. Gate-Source Voltage (Note E)

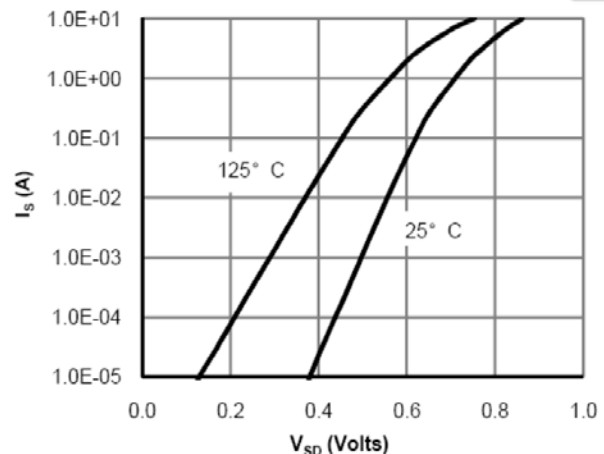

Figure 6: Body-Diode Characteristics (Note E)

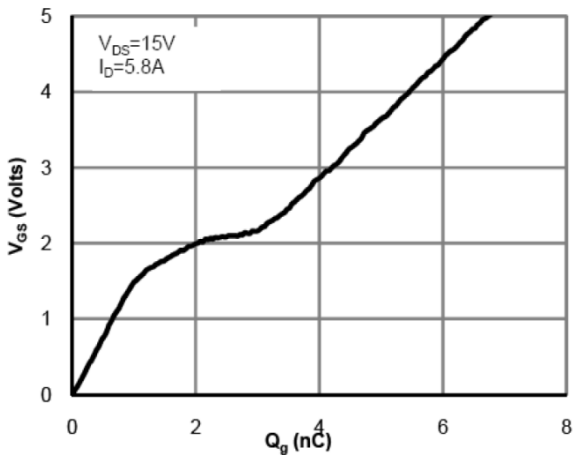

Figure 7: Gate-Charge Characteristics

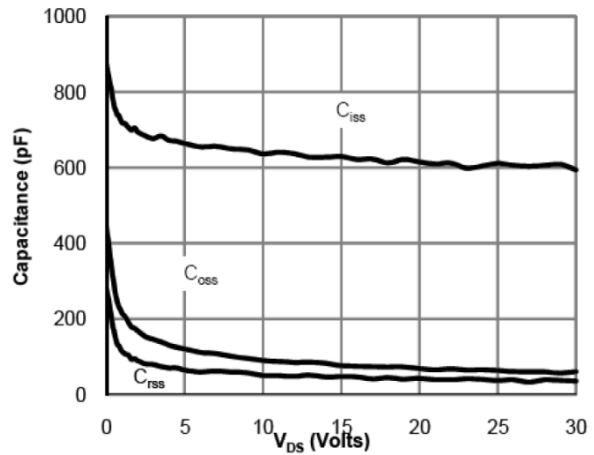

Figure 8: Capacitance Characteristics

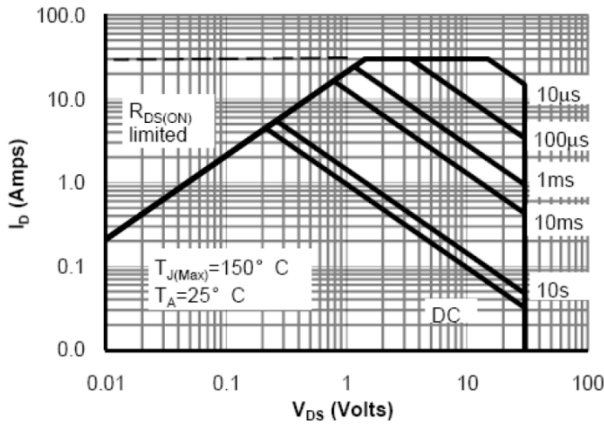

Figure 9: Maximum Forward Biased Safe Operating Area (Note F)

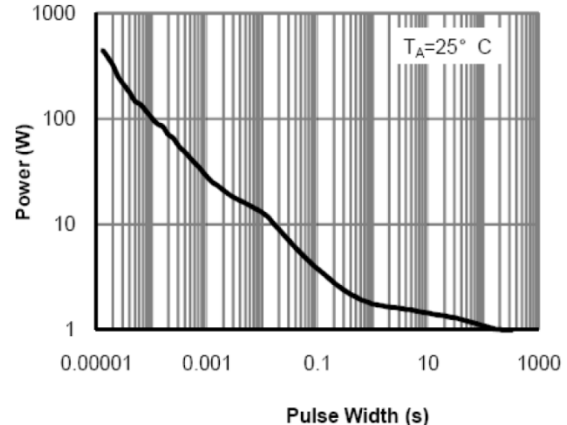

Figure 10: Single Pulse Power Rating Junction-to-Ambient (Note F)

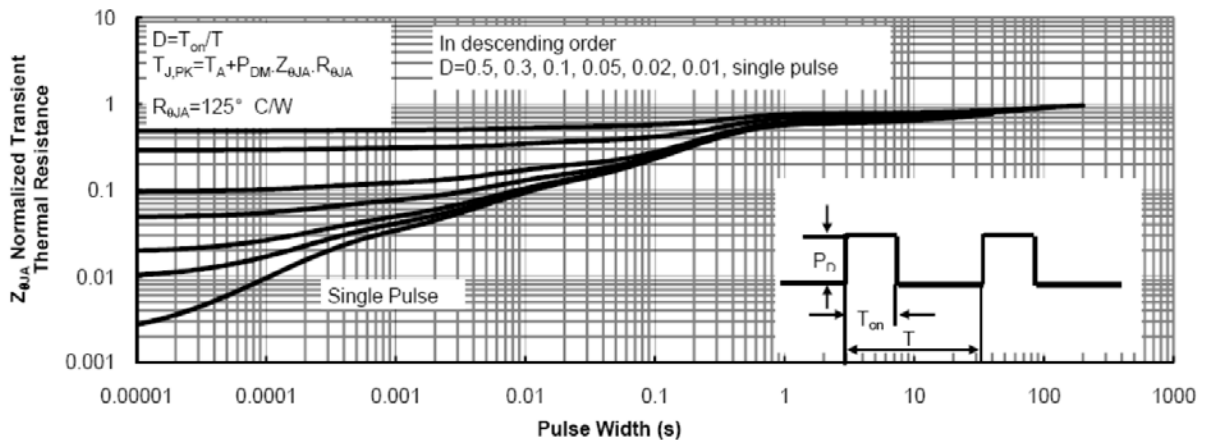
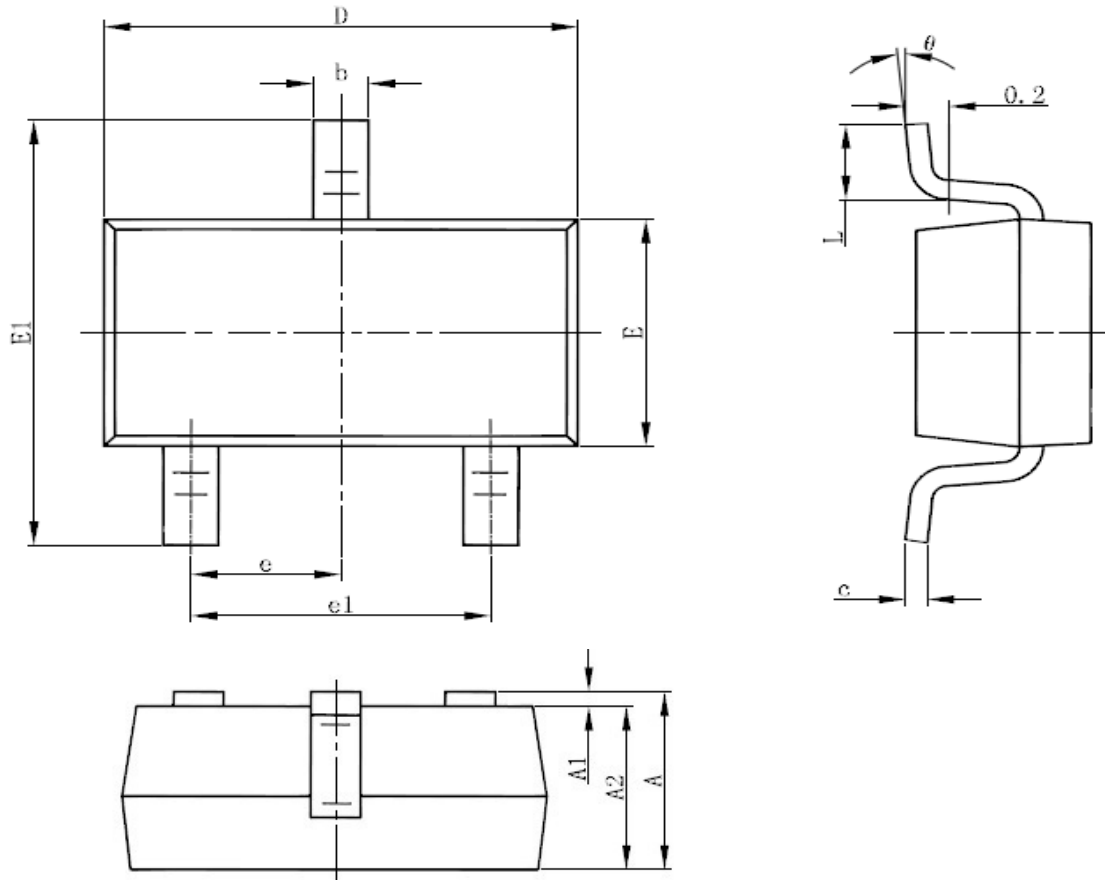

Figure 11: Normalized Maximum Transient Thermal Impedance (Note F)

SOT23-3L PACKAGE OUTLINE DIMENSIONS



Symbol	Dimensions In Millimeters		Dimensions In Inches	
	Min	Max	Min	Max
A	0.850	1.250	0.033	0.049
A1	0.000	0.100	0.000	0.004
A2	0.7	1.150	0.028	0.045
b	0.300	0.500	0.012	0.020
c	0.100	0.200	0.004	0.008
D	2.820	3.020	0.111	0.119
E	1.500	1.700	0.059	0.067
E1	2.650	2.950	0.104	0.116
e	0.950(BSC)		0.037(BSC)	
e1	1.800	2.000	0.071	0.079
L	0.300	0.600	0.012	0.024
θ	0°	8°	0°	8°

X-ON Electronics

Largest Supplier of Electrical and Electronic Components

Click to view similar products for [MOSFET](#) category:

Click to view products by [Eternal Semiconductor](#) manufacturer:

Other Similar products are found below :

[614233C](#) [648584F](#) [MCH3443-TL-E](#) [MCH6422-TL-E](#) [FDPF9N50NZ](#) [NTNS3A92PZT5G](#) [IRFD120](#) [IRFF430](#) [JANTX2N5237](#) [2N7000](#)
[AOD464](#) [2SK2267\(Q\)](#) [2SK2545\(Q,T\)](#) [405094E](#) [423220D](#) [MIC4420CM-TR](#) [VN1206L](#) [614234A](#) [715780A](#) [751625C](#)
[IPS70R2K0CEAKMA1](#) [BSF024N03LT3 G](#) [PSMN4R2-30MLD](#) [TK31J60W5,S1VQ\(O](#) [2SK2614\(TE16L1,Q\)](#) [DMN1017UCP3-7](#)
[EFC2J004NUZTDG](#) [FCAB21350L1](#) [P85W28HP2F-7071](#) [DMN1053UCP4-7](#) [NTE2384](#) [NTE2969](#) [NTE6400A](#) [DMC2700UDMQ-7](#)
[DMN2080UCB4-7](#) [DMN61D9UWQ-13](#) [US6M2GTR](#) [DMN31D5UDJ-7](#) [SSM6P54TU,LF](#) [DMP22D4UFO-7B](#) [IPS60R3K4CEAKMA1](#)
[DMN1006UCA6-7](#) [DMN16M9UCA6-7](#) [STF5N65M6](#) [IRF40H233XTMA1](#) [IPSA70R950CEAKMA1](#) [IPSA70R2K0CEAKMA1](#) [STU5N65M6](#)
[C3M0021120D](#) [DMN6022SSD-13](#)