

Part No. 1001011

GPS/GLONASS/Beidou/Galileo (On/Off Ground) or ISM FR4 Antenna

1.561, 1.575, 1.603 GHz or 868-928 MHz

Supports: Tracking, Smart Home, Agriculture, Automotive, Healthcare, Digital Signage, Wearables, Industrial Devices



*ISM layout offered in Appendix 1

GPS / GLONASS / Beidou / Galileo FR4 Antenna

1.559 – 1.610 GHz or
ISM 868 – 928 MHz

KEY BENEFITS

Stay-in-Tune

IMD antenna technology provides superior RF field containment, resulting in less interaction with surrounding components.

Quicker Time-to-Market

By optimizing antenna size, performance and emissions, customer and regulatory specifications are more easily met.

Reliability

Products are the latest RoHS version compliant.

APPLICATIONS

- Embedded design
- Cellular, Headsets, Tablets
- Gateway, Access Point
- Handheld
- Telematics
- Tracking
- Healthcare
- M2M, Industrial devices
- Smart Grid
- OBD-II

Real-World Performance and Implementation

Antennas may look alike on the outside, but the important difference is inside. Other antennas may contain simple PIFA or monopole designs that interact with their surroundings, complicating layout or changing performance with use position. Ethertronics' antennas utilize patented Isolated Magnetic Dipole (IMD) technology to deliver a unique size and performance combination.

Greater Flexibility

Ethertronics' IMD technology enables the advance antenna design that delivers superior performance in reception critical applications. 1001011 is capable for off-ground and on-ground (over metal) environments. The 1001011 can also achieve ISM performance with proper layout shown on Appendix 1.

Electrical Specifications

Typical Characteristics, on 72 x 50 mm PCB

Frequency (GHz)	1.559 - 1.563	1.575	1.559 - 1.591	1.593 - 1.610	*868 – 928 MHz
Mounting	Off Ground / On Ground				Off Ground
GNSS Bands	Beidou	GPS	Galileo	Glionass	Refer to Appendix 1
Peak Gain (dBi)	0.96 / -0.26	0.87 / -0.22	0.96 / -0.18	1.00 / -0.35	
Efficiency (%)	72 / 47	71 / 46	70 / 45	69 / 41	
Center Frequency f ₀ (GHz)	1.561	1.575	1.575	1.603	
VSWR	1.5:1 / 2.5:1				
Feed Point Impedance	50 Ω unbalanced				

Mechanical Specifications & Ordering Part Number

Ordering Part Number	1001011
Size (mm)	22.0 x 3.2 x 3.3
Mounting	Surface mounted to the PCB
Weight (grams)	0.45
Packaging	Tape & Reel
Demo Board	1001011-02 (GNSS Demo Board)
	1001011-04 (ISM Demo Board)



1.575 GHz Ethertronics' Embedded Antenna Specifications.
Ethertronics produces a wide variety of standard and custom antennas to meet user needs.

Antenna Dimensions

Typical antenna dimensions (mm)

Part Number	A (mm)	B (mm)	C (mm)
1001011	22.0 ± 0.3	3.2 ± 0.2	3.3 ± 0.3

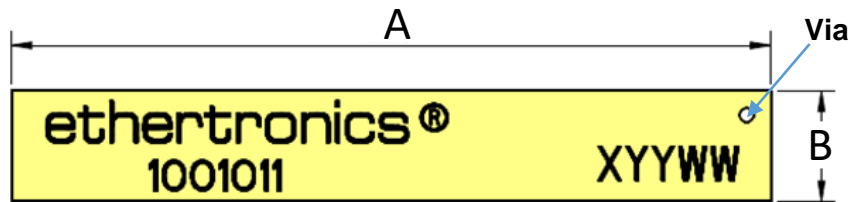
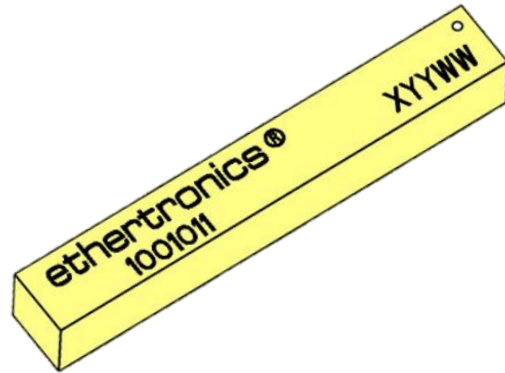

Top View

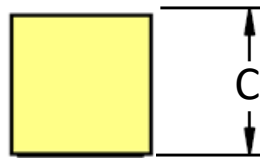

Height

Pin Descriptions

Pin#	Description
1	Feed
2	Dummy Pad
3	Dummy Pad
4	Dummy Pad

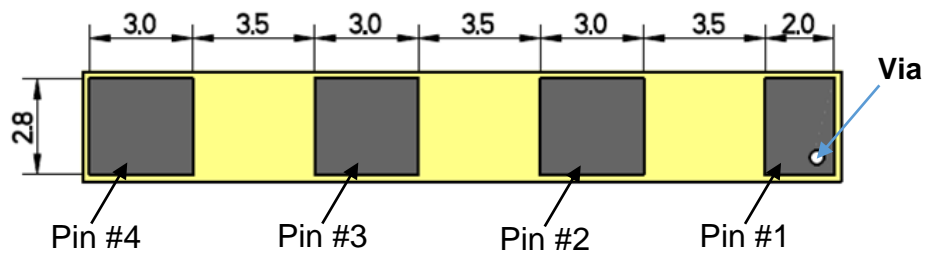

Bottom View



1.575 GHz Ethertronics' Embedded Antenna Specifications.
Ethertronics produces a wide variety of standard and custom antennas to meet user needs.

VSWR and Efficiency Plots (Off-Ground)

Typical Performances on 72 x 50 mm PCB

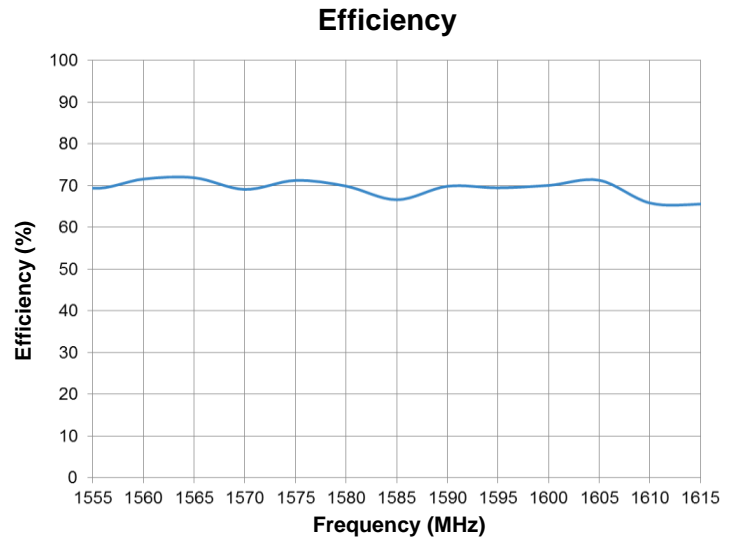
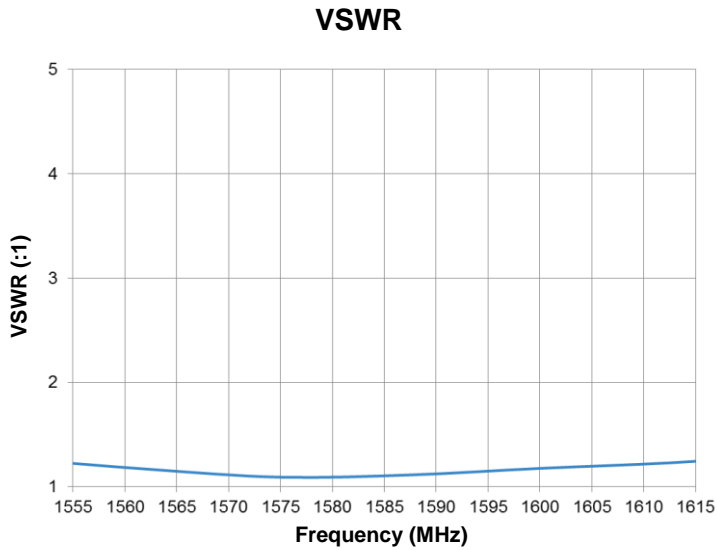

Antenna Radiation Patterns (Off-Ground)

Typical Performances on 72 x 50 mm PCB
measured @ 1.575 GHz

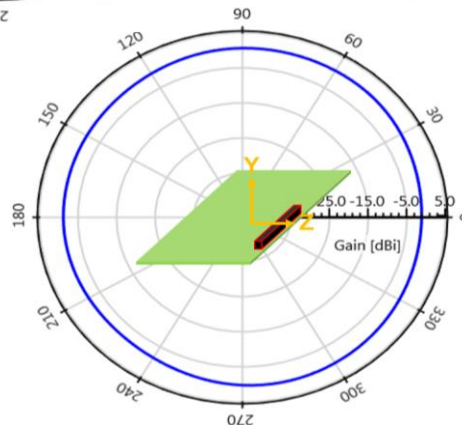
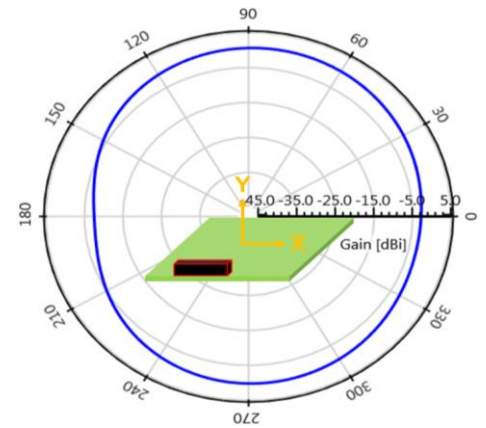
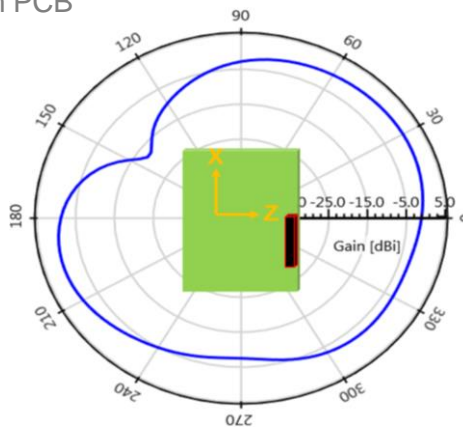



1.575 GHz Ethertronics' Embedded Antenna Specifications.
Ethertronics produces a wide variety of standard and custom antennas to meet user needs.

Antenna Layout (Off-Ground)

Typical layout dimensions (mm)

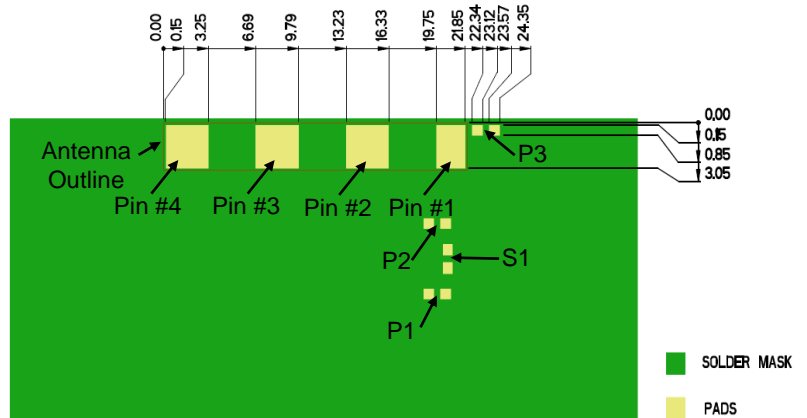
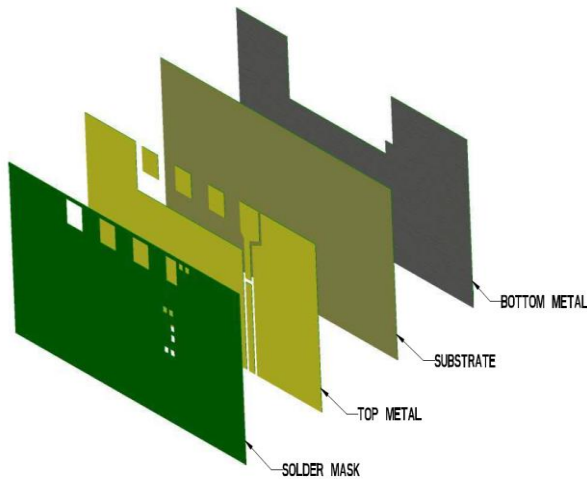

* VIAS: Diam. 0.2mm, (no vias on transmission lines).
Via holes must be covered by solder mask

Pin Descriptions

Pin#	Description
1	Feed
2	Dummy Pad
3	Dummy Pad
4	Dummy Pad

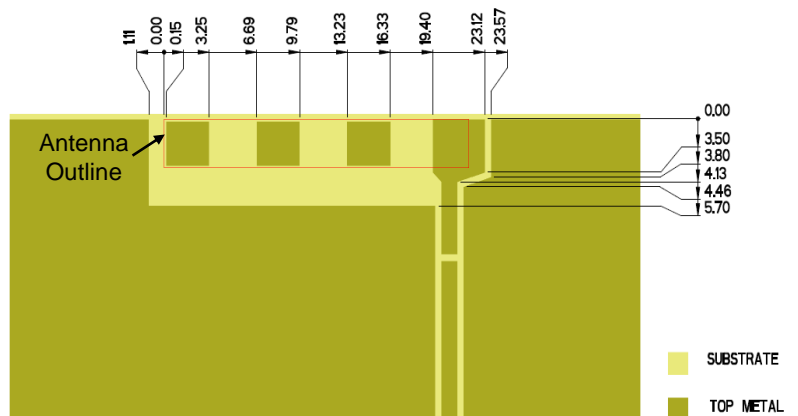

Matching Pi Network (Demo Board)

Component	Value	Tolerance
P1	DNI	N/A
S1	4.3pF	±0.25pF
P2	1pF	±0.5pF
P3	0Ω	N/A

*Actual matching values depend on customer design

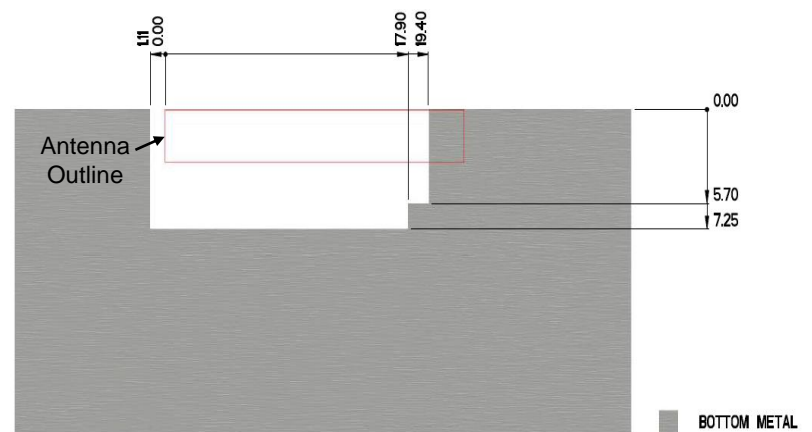
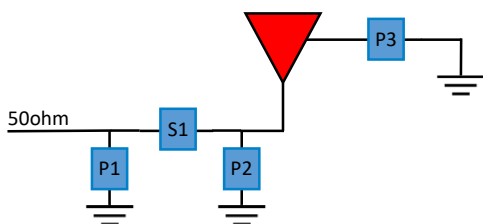



1.575 GHz Ethertronics' Embedded Antenna Specifications.
Ethertronics produces a wide variety of standard and custom antennas to meet user needs.

VSWR and Efficiency Plots (On-Ground)

Typical Performances on 72 x 50 mm PCB

VSWR

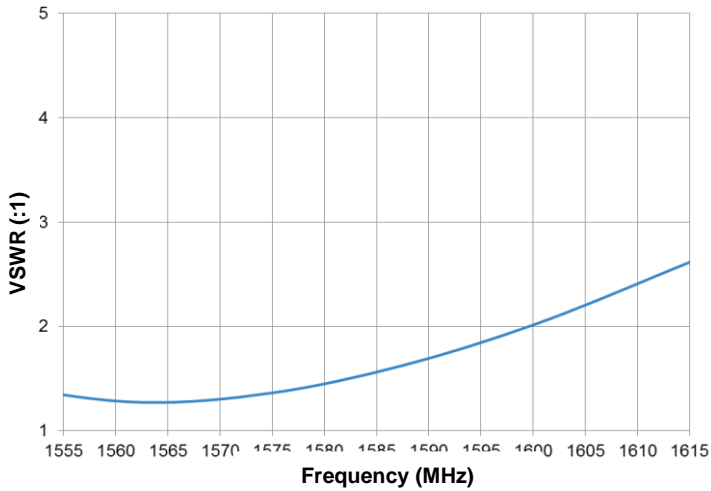

Efficiency

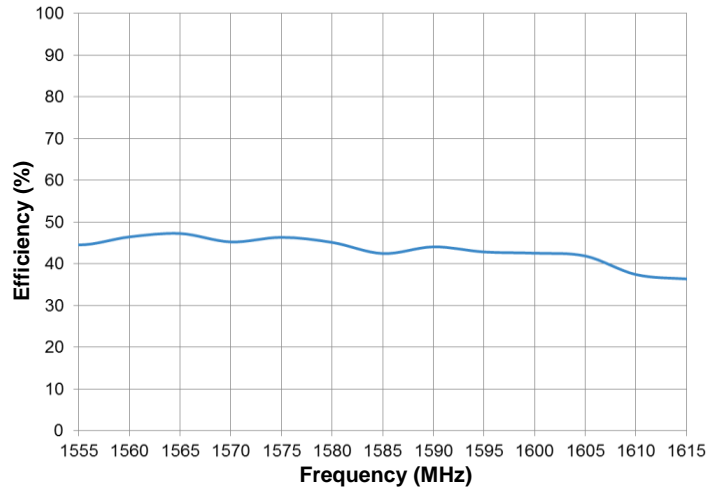

Antenna Radiation Patterns (On-Ground)

Typical Performances on 50 x 72 mm PCB
measured @ 1.575 GHz

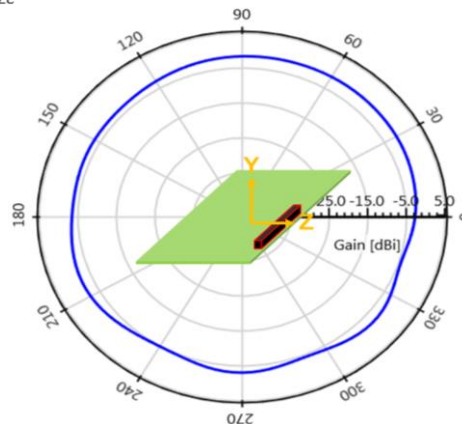
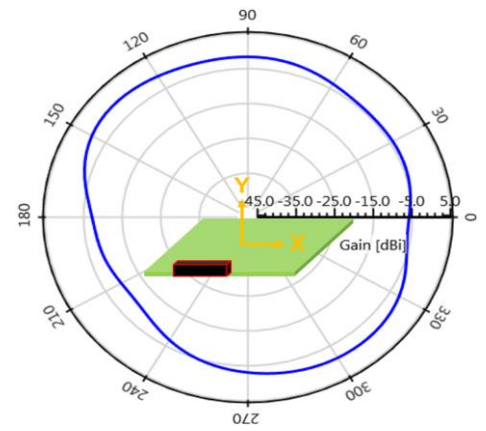
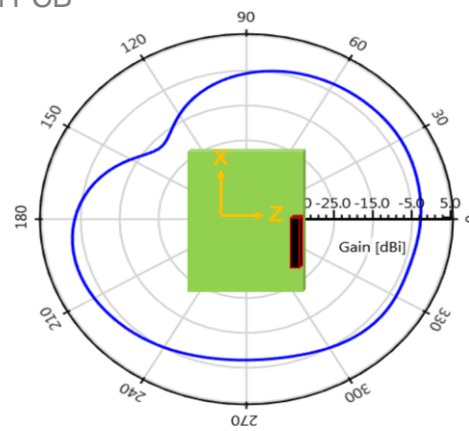



1.575 GHz Ethertronics' Embedded Antenna Specifications.
Ethertronics produces a wide variety of standard and custom antennas to meet user needs.

Antenna Layout (On-Ground)

Typical layout dimensions (mm)

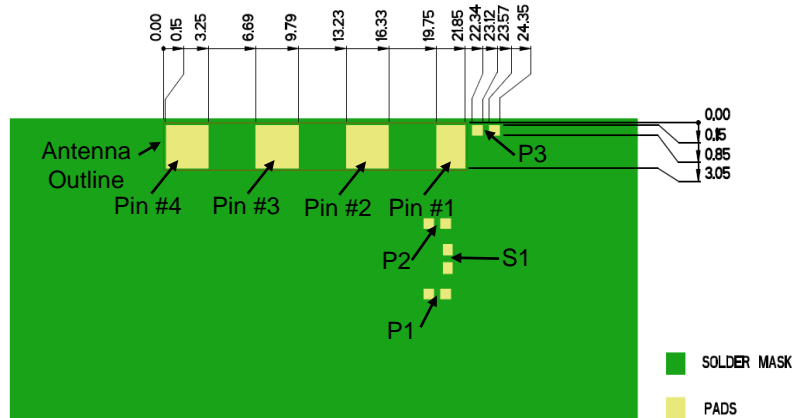
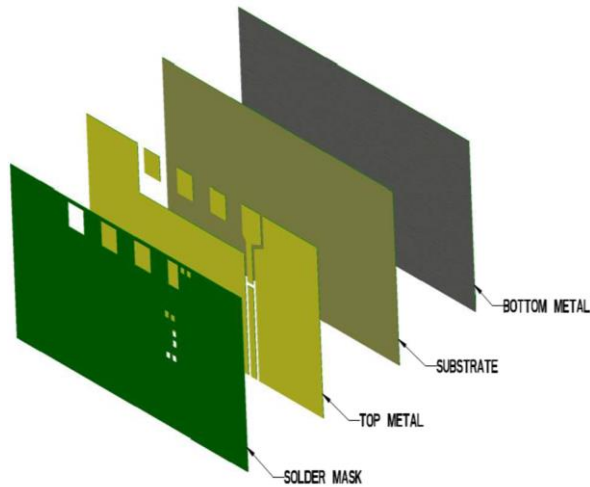

* VIAS: Diam. 0.2mm, (no vias on transmission lines).
Via holes must be covered by solder mask

Pin Descriptions

Pin#	Description
1	Feed
2	Dummy Pad
3	Dummy Pad
4	Dummy Pad

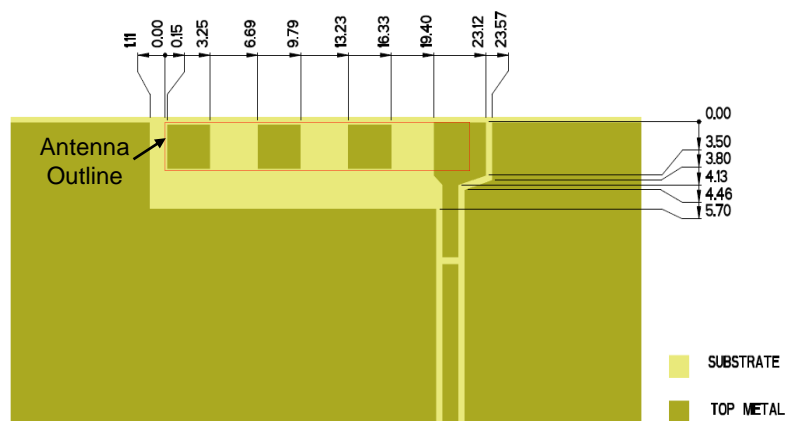

Matching Pi Network (Demo Board)

Component	Value	Tolerance
P1	2.4pF	±0.1pF
S1	0Ω	N/A
P2	DNI	N/A
P3	0Ω	N/A

*Actual matching values depend on customer design

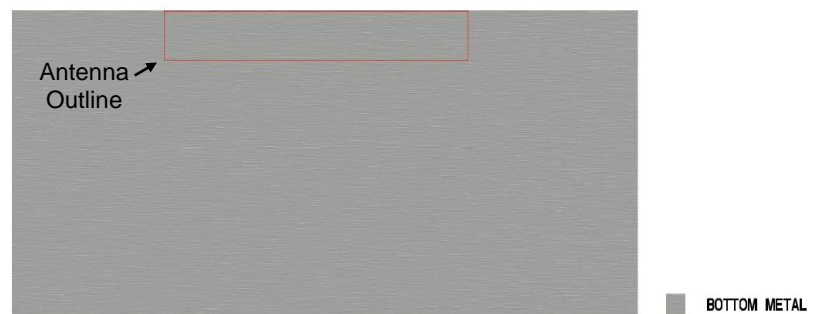
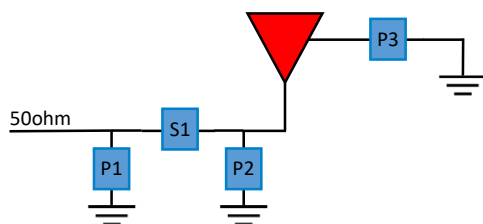



1.575 GHz Ethertronics' Embedded Antenna Specifications.
Ethertronics produces a wide variety of standard and custom antennas to meet user needs.

Antenna Demo Board
1001011-02 Off-Ground

Part Number	A (mm)	B (mm)	C (mm)
1001011-02	72.0	50.0	15.0

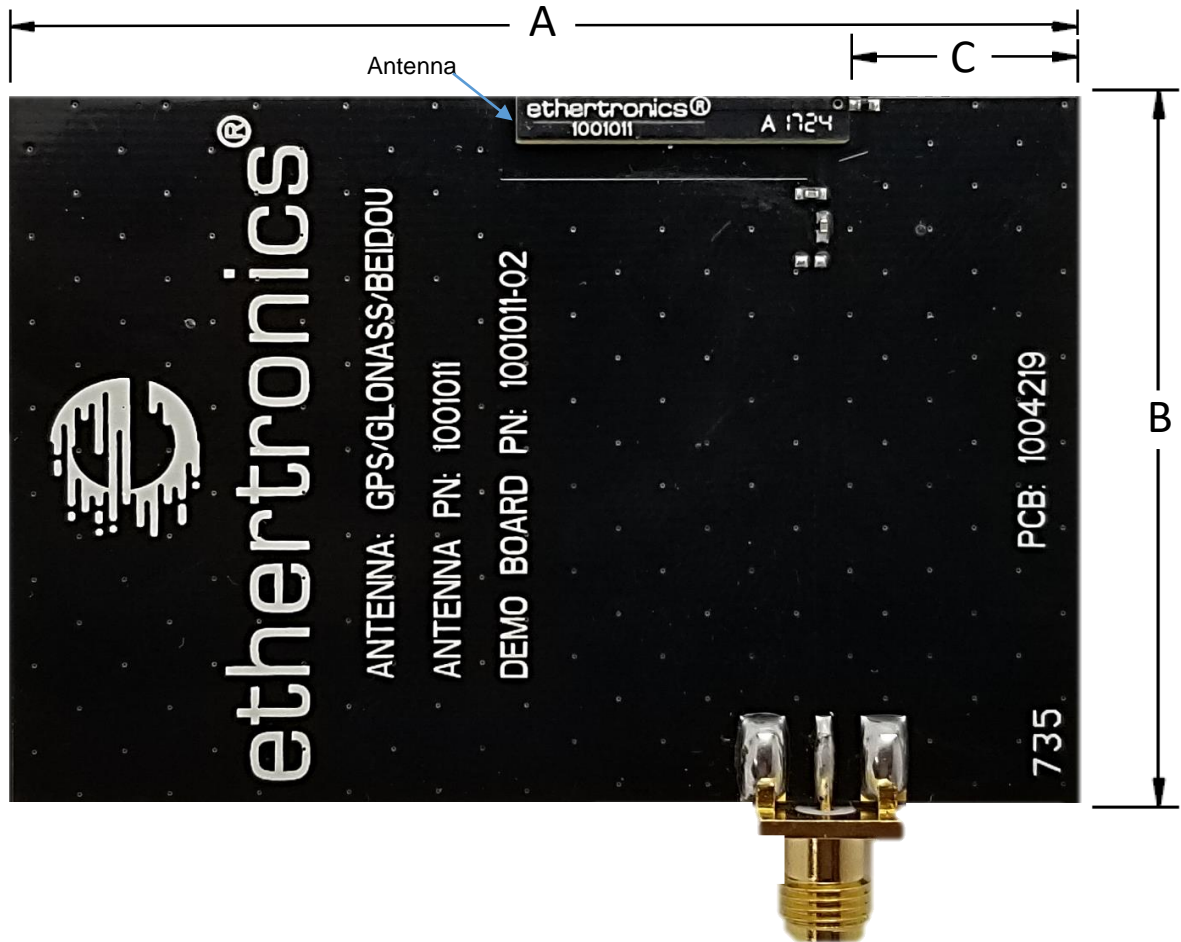



Appendix 1 ISM Ethertronics' Embedded Antenna Specifications.
Ethertronics produces a wide variety of standard and custom antennas to meet user needs.

Appendix 1

Appendix 1 gives instructions on how to match antenna through impedance matching network for ISM (868-928 MHz) only.

Frequency (MHz)	868 - 928
Mounting	Off Ground
Peak Gain (dBi)	1.0
Efficiency (%)	64
VSWR	<2.5:1
Feed Point Impedance	50 Ω unbalanced

*Data shown above has Appendix 1 matching applied on 115 x 26.5 mm pcb.

Part Number	A (mm)	B (mm)
1001011-04	26.5	115.0

***Appendix 1 Antenna Demo Board**

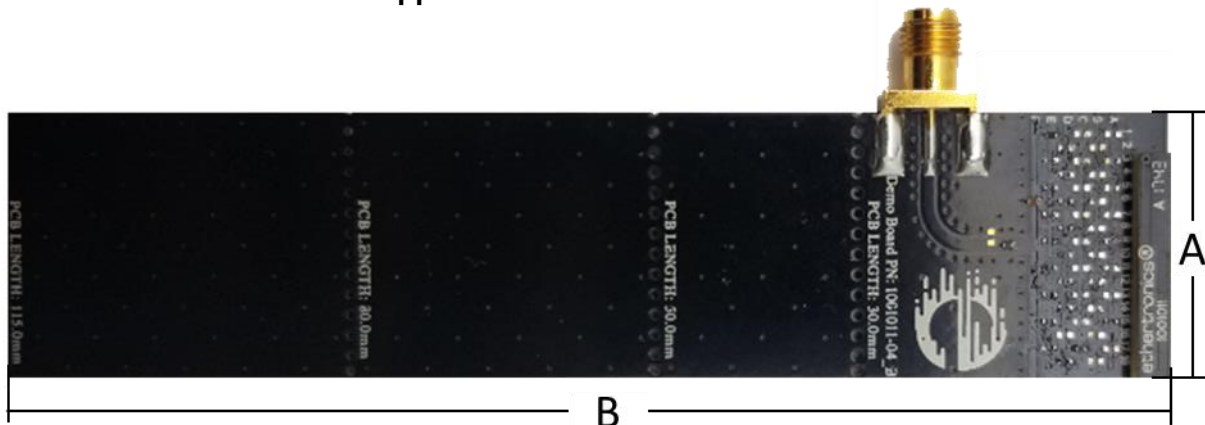



Appendix 1 ISM Ethertronics' Embedded Antenna Specifications.
Ethertronics produces a wide variety of standard and custom antennas to meet user needs.

Appendix 1 ISM Antenna Layout (Off-Ground)

Typical layout dimensions (mm)

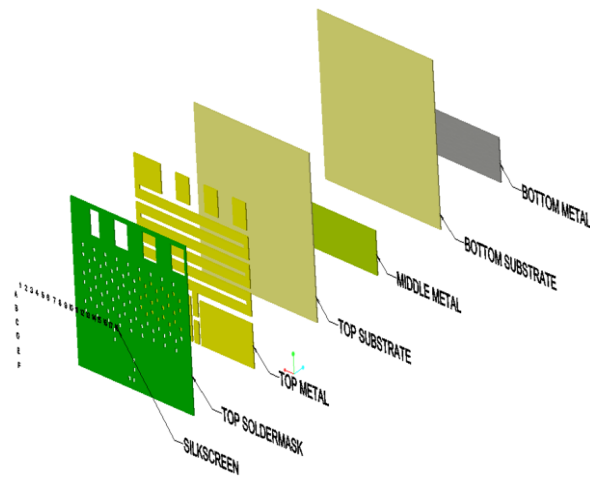

* VIAS: Diam. 0.2mm, (no vias on transmission lines).
Via holes must be covered by solder mask

Pin Descriptions

Pin#	Description
1	Feed
2	Dummy Pad
3	Dummy Pad
4	Dummy Pad

Matching Pi Network (Demo Board)

Component	Value	Tolerance	Board Label
P1	DNI	N/A	
S1	0Ω	N/A	
P2	18nH	±2%	F6
S2	0Ω	N/A	E1
S3	0Ω	N/A	D18
S4	DNI	N/A	C17

*Actual matching values depend on customer design

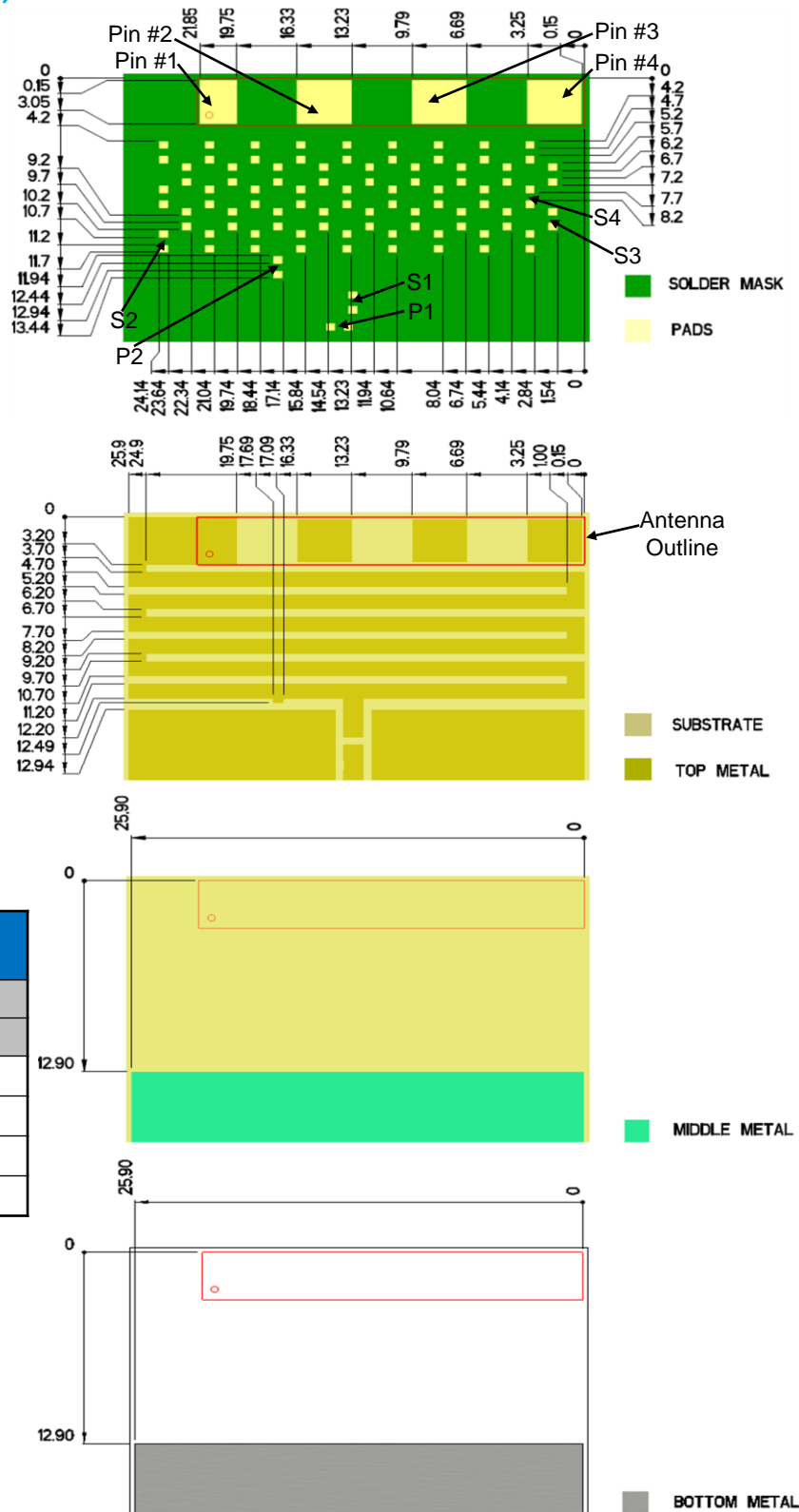
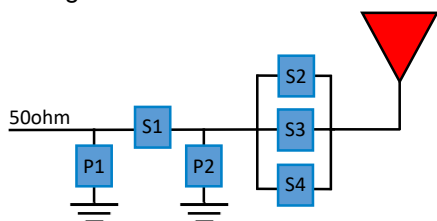



Appendix 1 ISM Ethertronics' Embedded Antenna Specifications.
Ethertronics produces a wide variety of standard and custom antennas to meet user needs.

Appendix 1 ISM Tuning Structure (Off-Ground)

Typical layout dimensions (mm)

Baseline Configuration

Component	Value	Tolerance	Board Label
P1	DNI	N/A	
S1	0Ω	N/A	
P2	18nH	±2%	F6
S2	0Ω	N/A	E1
S3	0Ω	N/A	D18
S4	DNI	N/A	C17

*Matching Pi Network (Baseline)

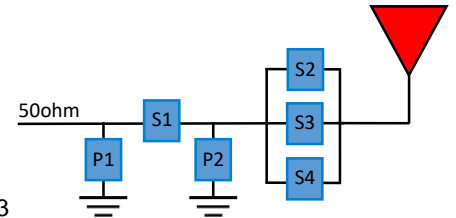
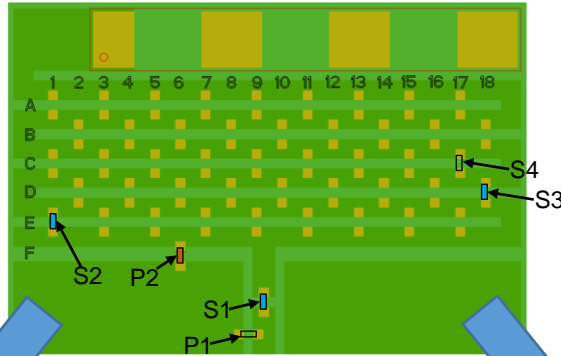

Tune Frequency <u>Lower?</u>	Outcome:
Move (S3) 0 Ohm from D18 towards D2 depending on requested antenna tuning. D18, D16, and D14 through D2 allows for on board tuning to shift frequency lower.	Antenna frequency will shift lower up to D2 tuning location

Tune Frequency <u>Higher?</u>	Outcome:
Keep (S3) 0 Ohm on D18. Add (S4) 0 Ohm on C17 to shift resonant frequency slightly higher. Continue to move C17 component towards C1 for more drastic tuning.	Antenna frequency will shift higher up to C1 tuning location

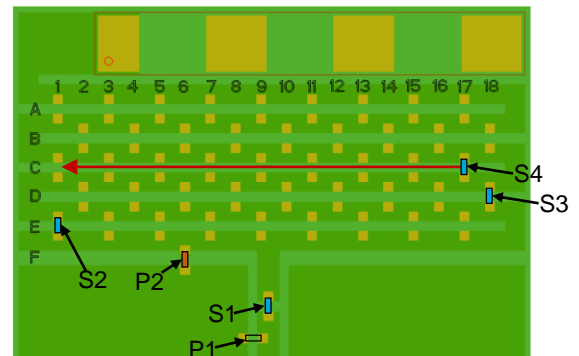
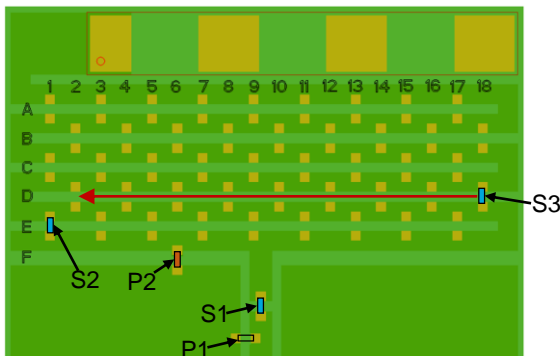

Component	Value	Tolerance	Board Label
P1	DNI	N/A	
S1	0Ω	N/A	
P2	18nH	±2%	F6
S2	0Ω	N/A	E1
S3	0Ω	N/A	D18-D2
S4	DNI	N/A	C17

Component	Value	Tolerance	Board Label
P1	DNI	N/A	
S1	0Ω	N/A	
P2	18nH	±2%	F6
S2	0Ω	N/A	E1
S3	0Ω	N/A	D18
S4	0Ω	N/A	C17- C1



Appendix 1 ISM Ethertronics' Embedded Antenna Specifications.
Ethertronics produces a wide variety of standard and custom antennas to meet user needs.

Appendix 1 VSWR and Efficiency Plots (Off-Ground)

Typical Performances on 115 x 26.5 mm PCB

VSWR

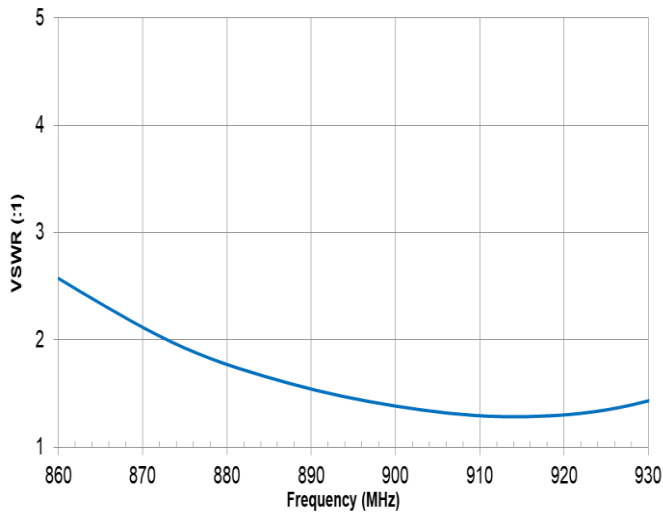

Efficiency

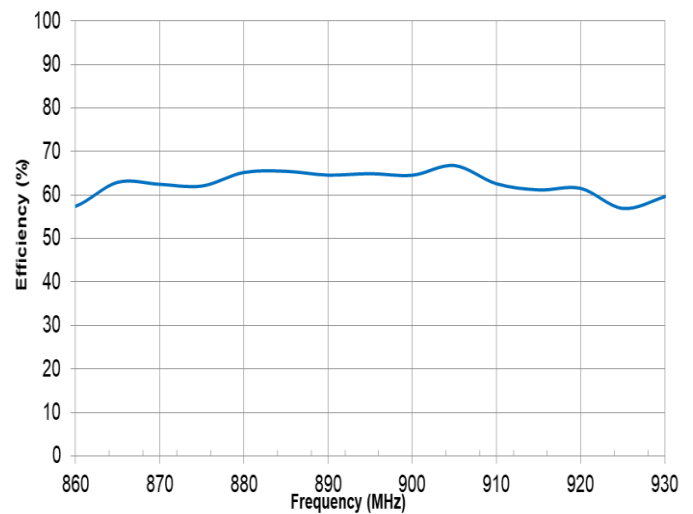

Antenna Radiation Patterns (Off-Ground)

Typical Performances on 115 x 26.5 mm PCB
measured @ 870, 910 MHz

- 870 MHz
- 910 MHz

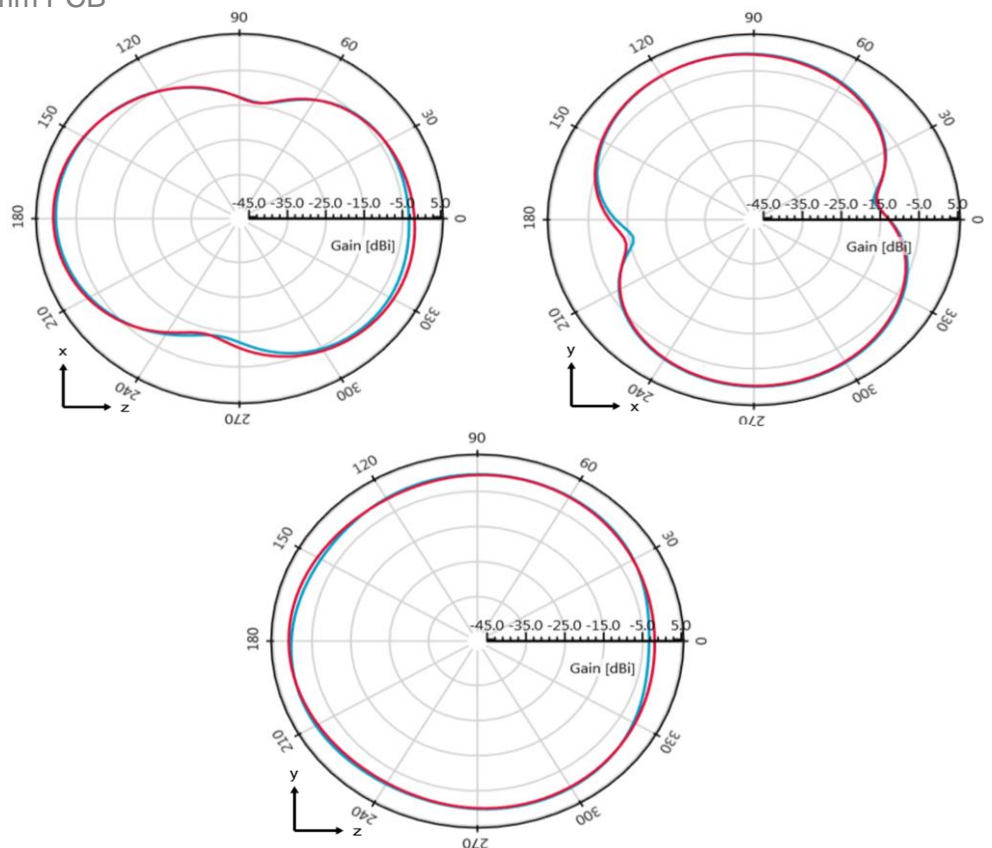
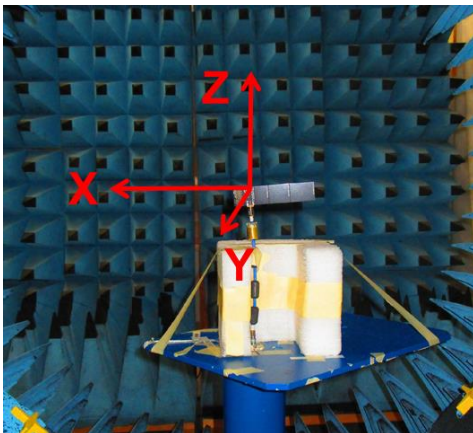

X-ON Electronics

Largest Supplier of Electrical and Electronic Components

Click to view similar products for [ethertronics](#) manufacturer:

Other Similar products are found below :

[1001011](#)