

General Description

The EA9103D is designed for portable RF and wireless applications with demanding performance and space requirements. The EA9103D performance is optimized for battery-powered systems to deliver ultra low quiescent current. Regulator ground current increases only slightly in dropout, further prolonging the battery life. The EA9103D also works with low-ESR ceramic capacitors, reducing the amount of board space necessary for power applications, critical in hand-held wireless devices. The EA9103D consumes less than 0.1uA in shutdown mode. The other features include ultra low dropout voltage, high output accuracy, current limiting protection and high ripple rejection ratio. The EA9103D is available in the SOT23-5 and DFN 1x1-4L packages.

Features

- ▶ 0.3uA Ultra-Low Quiescent Current
- ▶ 2V to 7V Input Voltage Range
- ▶ Low Dropout: 200mV@200mA
- ▶ 500mA Output Current
- ▶ 1.2V/1.8V/2.8V/2.5V/3.3V Output Voltage
- ▶ High PSRR: -70dB at 1KHz
- ▶ < 0.1uA Standby Current When Shutdown
- ▶ Fast Discharge
- ▶ Current Limiting and Thermal Shutdown Protection
- ▶ Available in SOT-23-5 and DFN 1x1-4L Packages

Applications

- ▶ Reference Power
- ▶ Portable Devices
- ▶ Bluetooth, Wireless Handsets

Pin Configurations

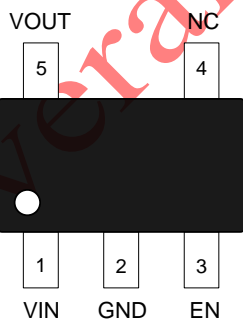

SOT23-5

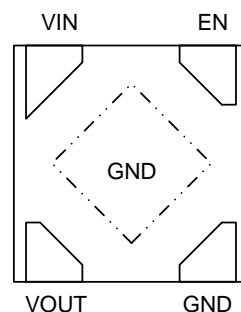

DFN 1x1-4L

Pin Description

Pin Name	Function Description	Pin No.	
		SOT23-5	DFN 1x1-4L
VIN	Power input voltage pin.	1	4
GND	Ground pin.	2	2, EP
EN	Enable pin. Do not leave this pin floating.	3	3
NC	Not Connect.	4	--
VOUT	Output voltage pin.	5	1

Function Block Diagram

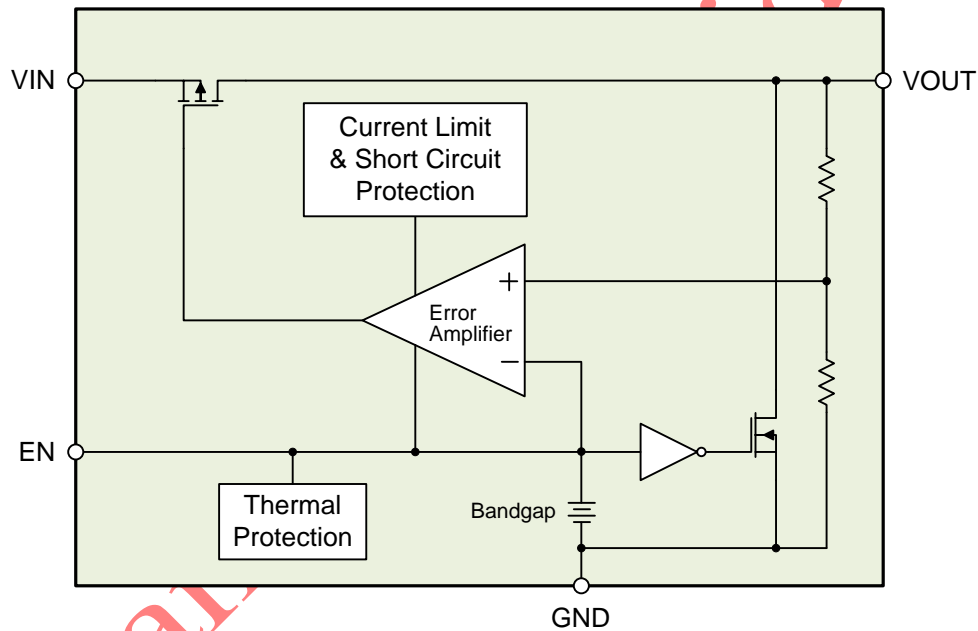

Figure 1. EA9103D internal function block diagram

Absolute Maximum Ratings

Parameter	Value
Input Supply Voltage (V _{IN})	-0.3V to +9V
Output Voltage (V _{OUT})	-0.3V to (V _{IN} +0.3)V
Output Current (I _{OUT})	550mA
Lead Temperature (Soldering, 10 sec)	+260°C
Storage Temperature Range (T _S)	-55°C to +150°C
ESD Susceptibility (HBM)	2kV
ESD Susceptibility (MM)	200V

Note (1): Stresses beyond those listed under "Absolute Maximum Ratings" may cause permanent damage to the device. Exposure to "Absolute Maximum Ratings" conditions for extended periods may affect device reliability and lifetime.

Package Thermal Characteristics

Parameter	Value
SOT-23-5/DFN 1x1-4L Thermal Resistance (θ _{JC})	125°C/W
SOT-23-5/DFN 1x1-4L Thermal Resistance (θ _{JA})	220°C/W
SOT-23-5/DFN 1x1-4L Power Dissipation at T _A =25°C (P _{Dmax})	0.55W

Note (1): P_{Dmax} is calculated according to the formula: P_{DMAX}=(T_{JMAX}-T_A)/ θ_{JA}.

Recommended Operating Conditions

Parameter	Value
Input Operating Voltage Range (V _{IN})	+2V to +7V
Ambient Temperature Range (T _A)	-40°C to +85°C
Junction Temperature Range (T _J)	-40°C to +125°C

EVERANALOG

Electrical Characteristics

$V_{IN} = V_{OUT} + 1V$, $V_{OUT} = 3.3V$, $C_{IN} = C_{OUT} = 1\mu F$, $T_A = 25^\circ C$, unless otherwise noted

Parameter	Symbol	Test Conditions	Min	Typ	Max	Unit
Output Voltage Accuracy	ΔV_{OUT}	$I_{OUT} = 1mA$	-1.5		1.5	%
Output Loading Current	I_{LOAD}	$V_{EN} = V_{IN}$, $V_{IN} > 2.2V$		500		mA
Current Limit	I_{LIM}			550		mA
Short Circuit Current	I_{SC}	$R_{LOAD} = 1\Omega$		90		mA
Quiescent Current	I_Q	$V_{EN} \geq 1.2V$, $I_{OUT} = 0mA$		0.3	0.8	μA
Dropout Voltage	V_{DROP}	$I_{OUT} = 200mA$, $V_{OUT} > 2.8V$		220	260	mV
		$I_{OUT} = 300mA$, $V_{OUT} > 2.8V$		370	410	mV
Line Regulation	ΔV_{LINE}	$V_{IN} = (V_{OUT} + 1V)$ to 7V, $I_{OUT} = 1mA$			0.3	%
Load Regulation	ΔV_{LOAD}	$1mA < I_{OUT} < 300mA$			35	mV
Standby Current	I_{STBY}	$V_{EN} = GND$, Shutdown			0.1	μA
EN Leakage Current	I_{EN}				0.1	μA
EN Threshold Low Voltage	V_{IL}	$V_{IN} = 3V$ to 5.5V, Shutdown			0.4	V
EN Threshold High Voltage	V_{IH}	$V_{IN} = 3V$ to 5.5V, Start-up	1.2			V
Output Noise Voltage		10Hz to 100kHz, $I_{OUT} = 200mA$, $C_{OUT} = 1\mu F$		100		$\mu VRMS$
Power Supply Rejection Rate $f = 1kHz$	PSRR	$C_{OUT} = 1\mu F$, $I_{OUT} = 100mA$		-70		dB
Power Supply Rejection Rate $f = 10kHz$				-65		dB
Thermal Shutdown Threshold	T_{SD}			165		$^\circ C$

Note (1): MOSFET on-resistance specifications are guaranteed by correlation to wafer level measurements.

(2): Thermal shutdown specifications are guaranteed by correlation to the design and characteristics analysis.

Application Circuit Diagram

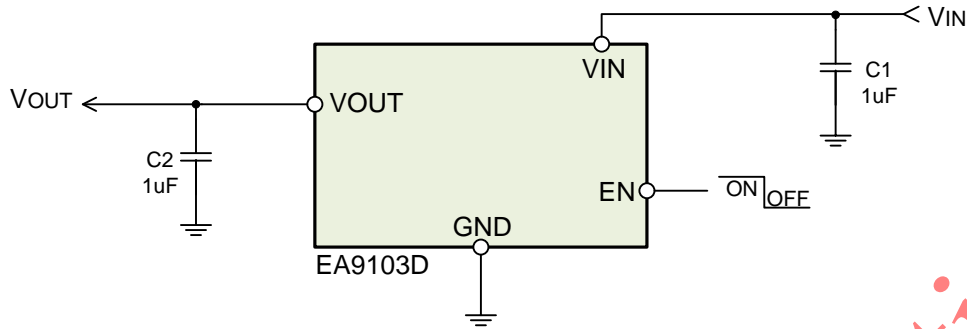

Figure 2. Typical application circuit diagram

Ordering Information

Part Number	Package Type	Packing Information
EA9103DVVT5R	SOT-23-5	Tape & Reel / 3000
EA9103DVVDGR	DFN 1x1-4L	Tape & Reel / 3000

Note (1): "VV": Output voltage version code.

(2): "T5/DG": Package type code.

(3): "R": Tape & Reel.

Output Voltage Version Code	Output Voltage
12	1.2V
18	1.8V
28	2.8V
25	2.5V
33	3.3V

Typical Operating Characteristics

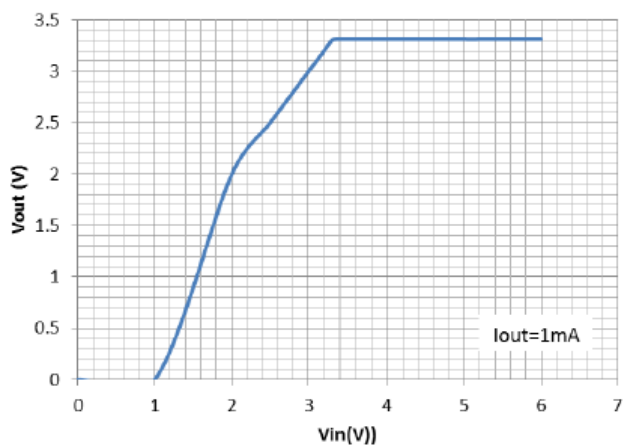

Line Regulation

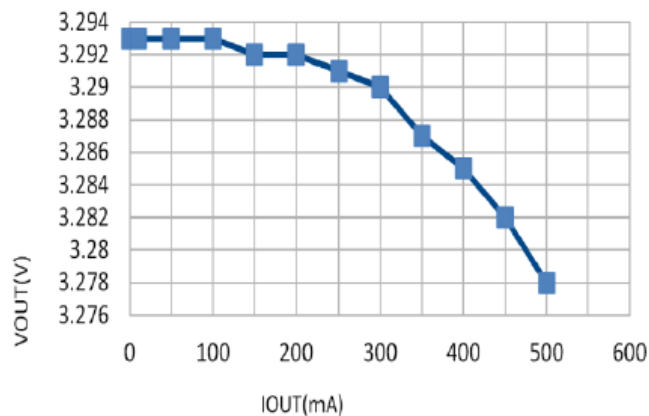

Load Regulation

V_{IN}=5V

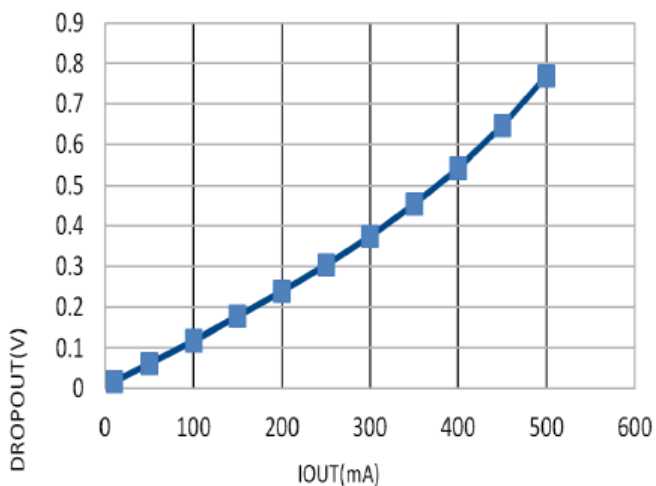

Dropout Voltage

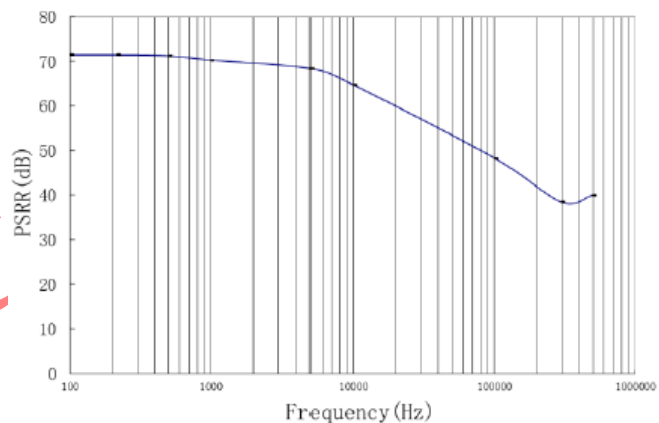

PSRR

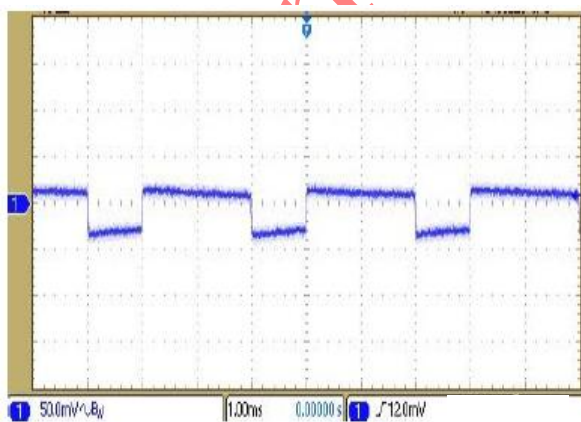

Load Transient Response

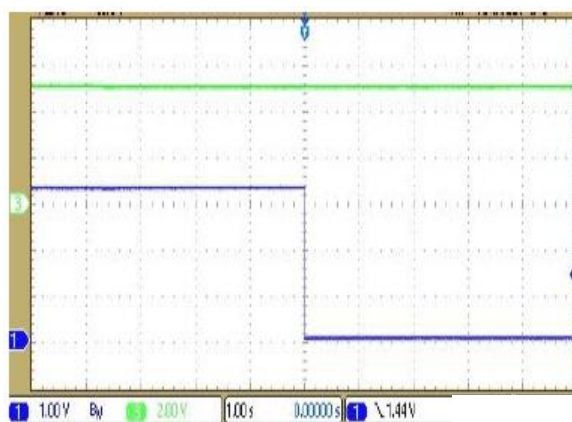

Short Circuit

Application Information

Like any low-dropout regulator, the external capacitors used with the EA9103D must be carefully selected for regulator stability and performance. Using a capacitor whose value is $> 1\mu\text{F}$ on the EA9103D input and the amount of capacitance can be increased without limit. The input capacitor must be located a distance that less than 0.5 inch from the input pin of the device to a clean analog ground. Any good quality ceramic or tantalum can be used for this capacitor. The capacitor with larger value and lower ESR (equivalent series resistance) provides better PSRR and line transient response. The output capacitor must meet both requirements for minimum amount of capacitance and ESR in all LDOs application. The EA9103D is designed specifically to work with low ESR ceramic output capacitor in space-saving and performance consideration. Using a ceramic capacitor whose value is at least $1\mu\text{F}$ with ESR is $> 25\text{m}\Omega$ on the EA9103D output ensures stability. The EA9103D still works well with output capacitor of other types due to the wide stable ESR range. Output capacitor of larger capacitance can reduce noise and improve load transient response, stability and PSRR. The EA9103D features an LDO regulator enable/disable function. To assure the LDO regulator will switch on, the EN turn on control level must be greater than 1.2V. The LDO regulator will go into the shutdown mode when the voltage on the EN pin falls below 0.4V. The EA9103D have a quick-discharge function to protecting the system.

Thermal Considerations

Thermal protection limits power dissipation in EA9103D. When the operation junction temperature exceeds 165°C , the OTP circuit starts the thermal shutdown function turn the pass element off. The pass element turn on again after the junction temperature cools by 30°C . For continue operation, do not exceed absolute maximum operation junction temperature 125°C . The maximum power dissipation depends on the thermal resistance of IC package, PCB layout, the rate of surroundings airflow and temperature difference between junction to ambient. The maximum power dissipation can be calculated by following formula:

$$P_{D(\text{MAX})} = (T_{J(\text{MAX})} - T_A) / \theta_{JA}$$

Where $T_{J(\text{MAX})}$ is the maximum operation junction temperature 125°C , T_A is the ambient temperature and the θ_{JA} is the junction to ambient thermal resistance. For recommended operating conditions specification of EA9103D, the $T_{J(\text{MAX})}$ is the maximum junction temperature of the die (125°C) and T_A is the maximum ambient temperature. The junction to ambient thermal resistance θ_{JA} for SOT23-5 package is 220°C/W .

Everanalog Confidential

Package Information

SOT-23-5 Package

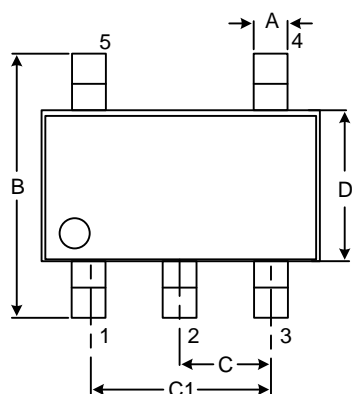

Top View

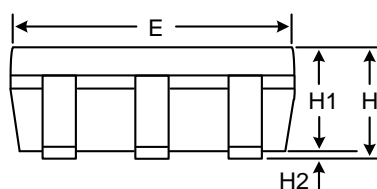

Side View

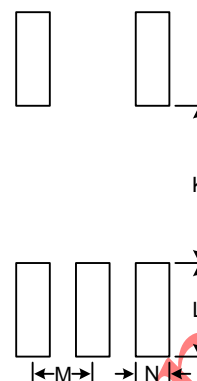

Recommended Layout Pattern

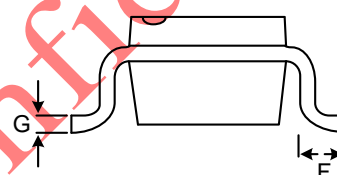

Front View

Unit: mm

Symbol	Dimension		Symbol	Dimension
	Min	Max		Typ
A	0.30	0.50	K	1.40
B	2.65	2.95	L	1.40
C	0.85	1.05	M	0.95
C1	1.80	2.00	N	0.65
D	1.50	1.70		
E	2.82	3.02		
F	0.30	0.60		
G	0.10	0.20		
H	1.05	1.25		
H1	1.05	1.15		
H2	0.00	0.10		

DFN 1mmx1mm-4L Package

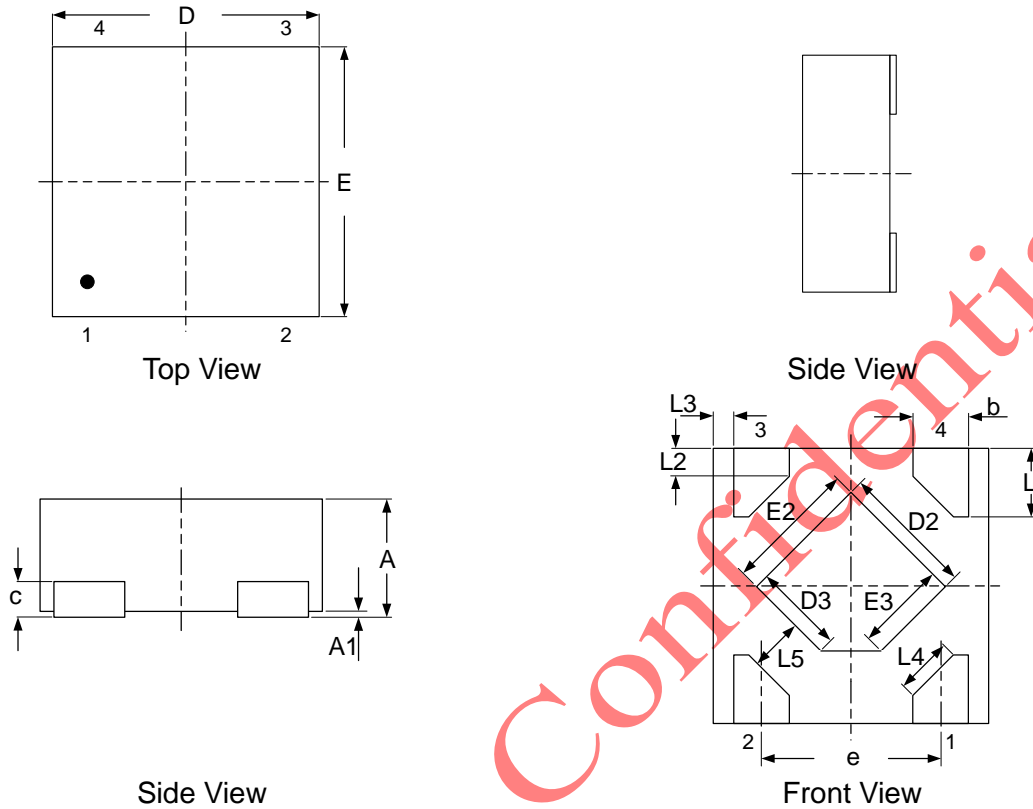

Unit: mm

Symbol	Dimension		
	Min	Nor	Max
A	0.35		0.40
A1	0.00	0.02	0.05
b	0.15	0.20	0.25
c		0.127	
D	0.95	1.00	1.05
D2	0.38	0.48	0.58
D3	0.23	0.33	0.43
e		0.65	
E	0.95	1.00	1.05
E2	0.38	0.48	0.58
E3	0.23	0.33	0.43
L	0.20	0.25	0.30
L2		0.103	
L3		0.075	
L4		0.208	
L5		0.200	

X-ON Electronics

Largest Supplier of Electrical and Electronic Components

Click to view similar products for [Linear Voltage Regulators](#) category:

Click to view products by [Everanalog](#) manufacturer:

Other Similar products are found below :

[LV5684PVD-XH](#) [MCDTSA6-2R](#) [L7815ACV-DG](#) [LV56801P-E](#) [UA7805CKC](#) [714954EB](#) [ZMR500QFTA](#) [BA033LBSG2-TR](#)

[NCV78M05ABDTRKG](#) [LV5680P-E](#) [L79M05T-E](#) [L78LR05D-MA-E](#) [NCV317MBTG](#) [NTE7227](#) [MP2018GZD-33-P](#) [MP2018GZD-5-P](#)

[LV5680NPVC-XH](#) [ZTS6538SE](#) [UA78L09CLP](#) [UA78L09CLPR](#) [CAT6221-PPTD-GT3](#) [MC78M09CDTRK](#) [NCV51190MNTAG](#)

[BL1118CS8TR1833](#) [BL8563CKETR18](#) [BL8077CKETR33](#) [BL9153-33CC3TR](#) [BL9161G-15BADRN](#) [BL9161G-28BADRN](#)

[BRCO7530MMC](#) [CJ7815B-TFN-ARG](#) [LM317C](#) [GM7333K](#) [GM7350K](#) [XC6206P332MR](#) [HT7533](#) [LM7912S/TR](#) [LT1764S/TR](#) [LM7805T](#)

[LM338T](#) [LM1117IMP-3.3/TR](#) [HT1117AM-3.3](#) [HT7550S](#) [AMS1117-3.3](#) [HT7150S](#) [78L12](#) [HT7550](#) [HT7533-1](#) [HXY6206I-2.5](#) [HT7133](#)