

High Performance Four Channels Audio ADC

FEATURES

- High performance multi-bit delta-sigma audio ADC
- 102 dB signal to noise ratio
- -85 dB THD+N
- 24-bit, 8 to 100 kHz sampling frequency
- I²S/PCM master or slave serial data port
- Support TDM
- 256/384Fs, USB 12/24 MHz and other non standard audio system clocks
- Low power standby mode

APPLICATIONS

- Mic array
- Smart speaker
- Far field voice capture

ORDERING INFORMATION

ES7210 -40°C ~ +85°C
QFN-32

BLOCK DIAGRAM

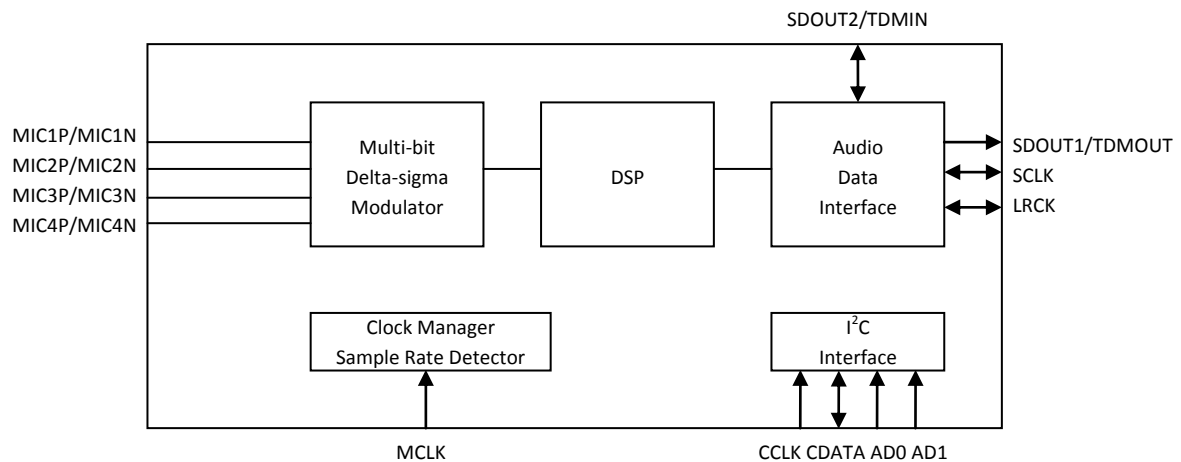

1. PIN OUT AND DESCRIPTION

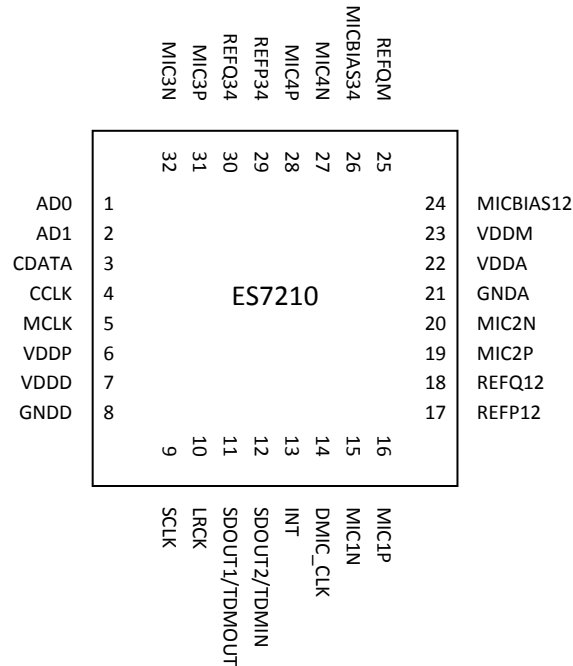

Pin Name	Pin number	Input or Output	Pin Description
CCLK, CDATA	3, 4	I/O	I ² C clock and data
ADO, AD1	1, 2	I	I ² C address
MCLK	5	I	Master clock
SCLK	9	I/O	Serial data bit clock
LRCK	10	I/O	Serial data left and right channel frame clock
SDOUT1/TDMOUT	11	O	Serial data output or TDM data input and output
SDOUT2/TDMIN	12	I/O	
INT	13	O	Interrupt
DMIC_CLK	14	O	Digital mic clock
MIC1P, MIC1N	16, 15	Analog	Mic input
MIC2P, MIC2N	19, 20		
MIC3P, MIC3N	31, 32		
MIC4P, MIC4N	28, 27		
MICBIAS12	24	Analog	Mic bias
MICBIAS34	26	Analog	
VDDP	6	Analog	Power supply for the digital input and output
VDDD, GNDD	7, 8	Analog	Digital power supply
VDDA, GNDA	22, 21	Analog	Analog power supply
VDDM	23	Analog	Analog power supply
REFP12, REFP34	17, 29	Analog	Filtering capacitor connection
REFQ12, REFQ34	18, 30	Analog	Filtering capacitor connection
REFQM	25	Analog	Filtering capacitor connection

2. TYPICAL APPLICATION CIRCUIT

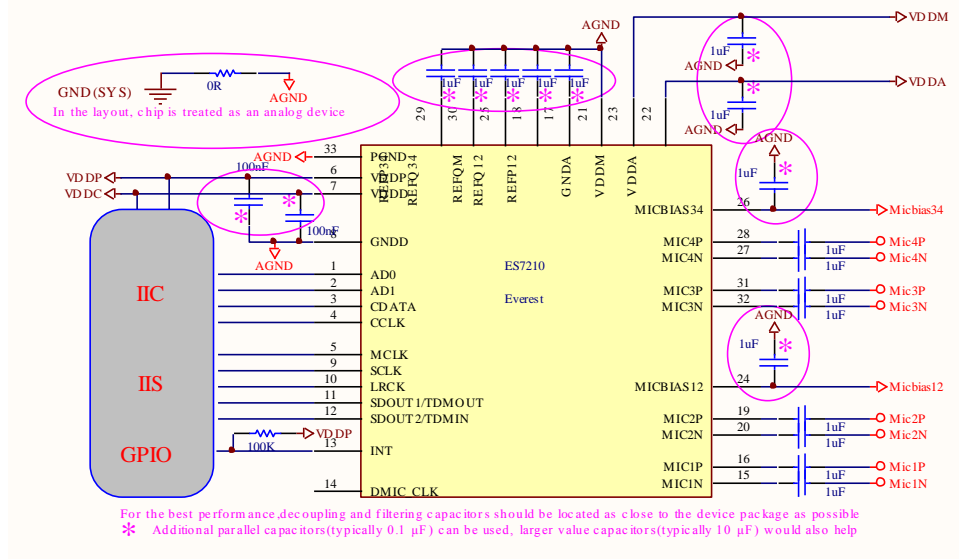

3. CLOCK MODES AND SAMPLING FREQUENCIES

The device supports standard audio clocks (256Fs, 384Fs, 512Fs, etc), USB clocks (12/24 MHz), and some common non standard audio clocks (25 MHz, 26 MHz, etc).

According to the serial audio data sampling frequency (F_s), the device can work in two speed modes: single speed mode or double speed mode. In single speed mode, F_s normally ranges from 8 kHz to 48 kHz, and in double speed mode, F_s normally range from 64 kHz to 96 kHz.

The device can work either in master clock mode or slave clock mode. In slave mode, LRCK and SCLK are supplied externally, and LRCK and SCLK must be synchronously derived from the system clock with specific rates. In master mode, LRCK and SCLK are derived internally from device master clock.

4. MICRO-CONTROLLER CONFIGURATION INTERFACE

The device supports standard I²C micro-controller configuration interface. External micro-controller can completely configure the device through writing to internal configuration registers.

I²C interface is a bi-directional serial bus that uses a serial data line (CDATA) and a serial clock line (CCLK) for data transfer. The timing diagram for data transfer of this interface is given in Figure 1a and Figure 1b. Data are transmitted synchronously to CCLK clock on the CDATA line on a byte-by-byte basis. Each bit in a byte is sampled during CCLK high with MSB bit being transmitted firstly. Each transferred byte is followed by an acknowledge bit from receiver to pull the CDATA low. The transfer rate of this interface can be up to 400 kbps.

A master controller initiates the transmission by sending a “start” signal, which is defined as a high-to-low transition at CDATA while CCLK is high. The first byte transferred is the slave address. It is a seven-bit chip address followed by a RW bit. The chip address must be 1000 0x, where x equals AD1 AD0. The RW bit indicates the slave data transfer direction. Once an acknowledge bit is received, the data transfer starts to proceed on a byte-by-byte basis in the direction specified by the RW bit. The master can terminate the communication by generating a “stop” signal, which is defined as a low-to-high transition at CDATA while CCLK is high.

In I²C interface mode, the registers can be written and read. The formats of “write” and “read” instructions are shown in Table 1 and Table 2. Please note that, to read data from a register, you must set R/W bit to 0 to access the register address and then set R/W to 1 to read data from the register.

Table 1 Write Data to Register in I²C Interface Mode

	Chip Address	R/W		Register Address		Data to be written		
start	1000 0 AD1 AD0	0	ACK	RAM	ACK	DATA	ACK	Stop

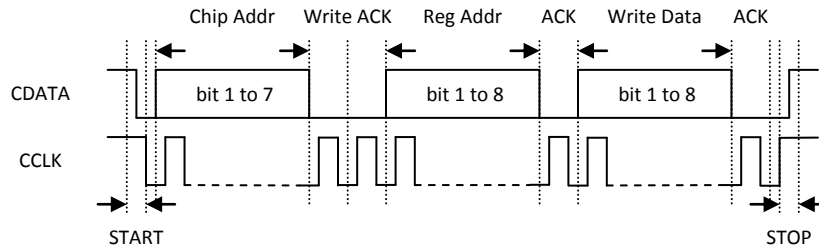

Figure 1a I²C Write Timing

Table 2 Read Data from Register in I²C Interface Mode

	Chip Address	R/W		Register Address		
Start	1000 0 AD1 AD0	0	ACK	RAM	ACK	
	Chip Address	R/W		Data to be read		
Start	1000 0 AD1 AD0	1	ACK	Data	NACK	Stop

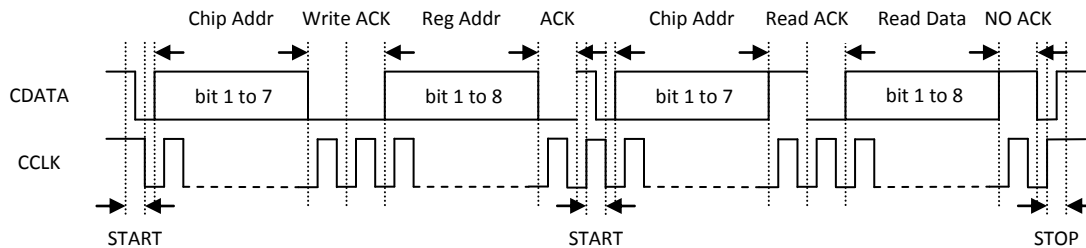

Figure 1b I²C Read Timing

5. DIGITAL AUDIO INTERFACE

The device provides many formats of serial audio data interface to the output from the ADC through LRCK, SCLK and SDOUT pins. These formats are I²S, left justified, DSP/PCM mode and TDM. ADC data is out at SDOUT on the falling edge of SCLK. The relationships of SDOUT, SCLK and LRCK with these formats are shown through Figure 2a to Figure 2h. ES7210 can be cascaded up to 16-ch through single I²S or TDM, please refer to the user guide for detail description.

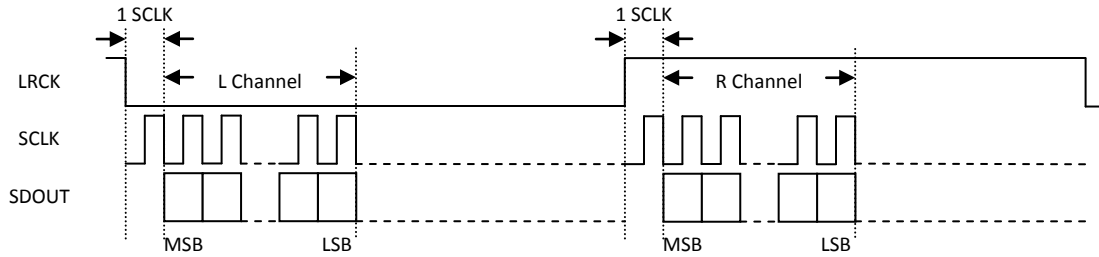

Figure 2a I²S Serial Audio Data Format

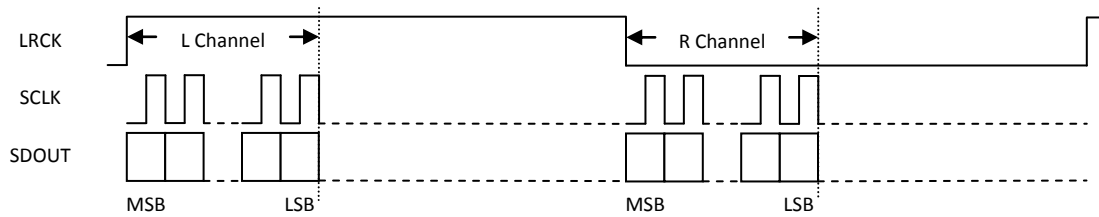

Figure 2b Left Justified Serial Audio Data Format

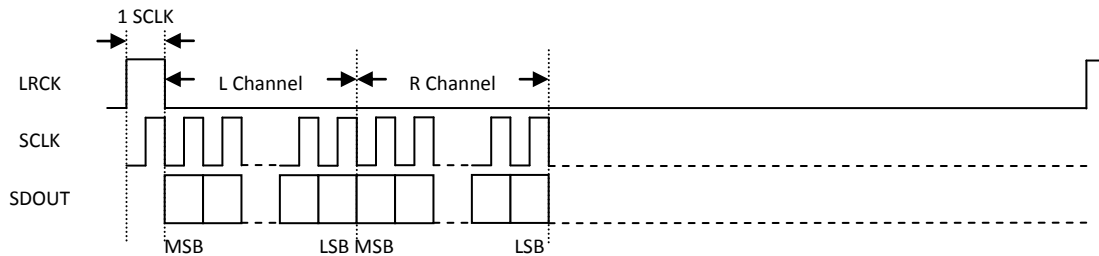

Figure 2c DSP/PCM Mode A Serial Audio Data Format

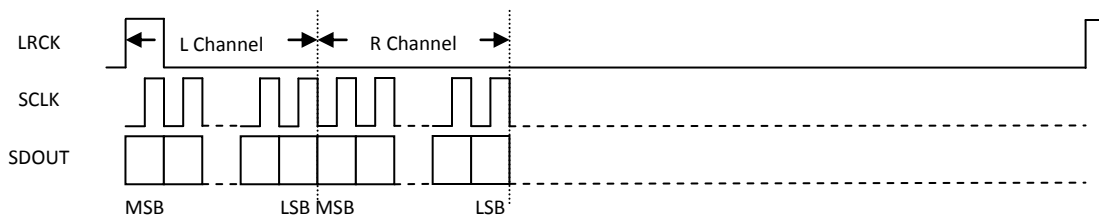

Figure 2d DSP/PCM Mode B Serial Audio Data Format

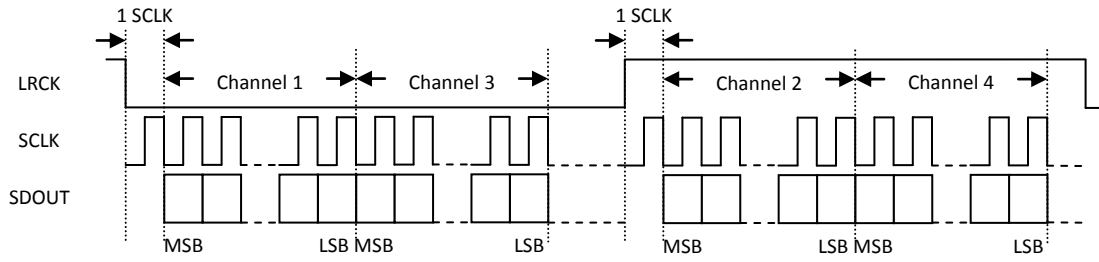

Figure 2e TDM I²S Serial Audio Data Format

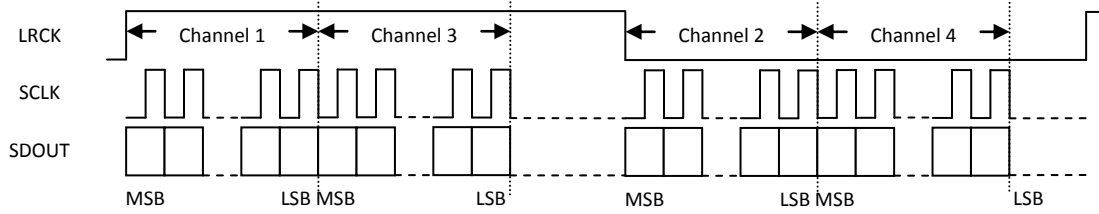

Figure 2f TDM Left Justified Serial Audio Data Format

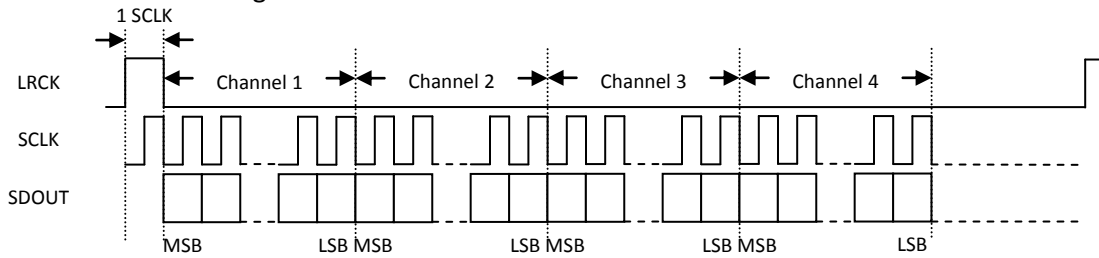

Figure 2g TDM DSP/PCM Mode A Serial Audio Data Format

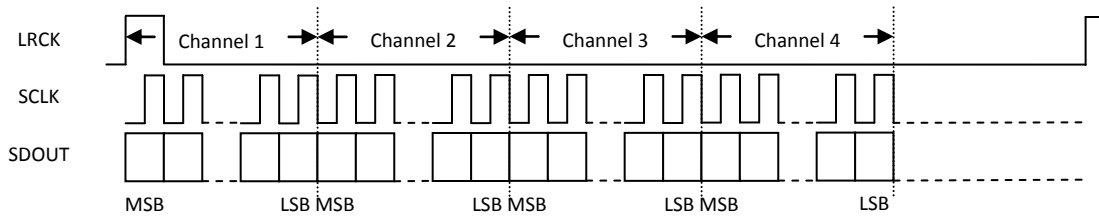

Figure 2h TDM DSP/PCM Mode B Serial Audio Data Format

6. ELECTRICAL CHARACTERISTICS

ABSOLUTE MAXIMUM RATINGS

Continuous operation at or beyond these conditions may permanently damage the device.

PARAMETER	MIN	MAX
Analog Supply Voltage Level	-0.3V	+3.6V
Digital Supply Voltage Level	-0.3V	+3.6V
Analog Input Voltage Range	GNDA-0.3V	VDDA+0.3V
Digital Input Voltage Range	GNDD-0.3V	VDDP+0.3V
Operating Temperature Range	-40°C	+85°C
Storage Temperature	-65°C	+150°C

RECOMMENDED OPERATING CONDITIONS

PARAMETER	MIN	TYP	MAX	UNIT
VDDD	1.6	3.3	3.6	V
VDDP	1.6	3.3	3.6	V
VDDA	1.6 (Note)	3.3	3.6	V
VDDM	1.6	3.3	3.6	V

Note: For VDDA is less than 2V, PGA gain must set above 30 dB.

ADC ANALOG AND FILTER CHARACTERISTICS AND SPECIFICATIONS

Test conditions are as the following unless otherwise specify: VDDA=3.3V, VDDD=3.3V, AGND=0V, DGND=0V, Ambient temperature=25°C, Fs=48 KHz, 96 KHz or 192 KHz, MCLK/LRCK=256.

PARAMETER	MIN	TYP	MAX	UNIT
ADC Performance				
Signal to Noise ratio (A-weight)	95	102	104	dB
THD+N	-88	-85	-75	dB
Channel Separation (1KHz)	95	100	105	dB
Interchannel Gain Mismatch		0.1		dB
Gain Error			±5	%
Filter Frequency Response – Single Speed				
Passband	0		0.4535	Fs
Stopband	0.5465			Fs
Passband Ripple			±0.05	dB
Stopband Attenuation	70			dB
Filter Frequency Response – Double Speed				
Passband	0		0.4167	Fs
Stopband	0.5833			Fs
Passband Ripple			±0.005	dB
Stopband Attenuation	70			dB
Filter Frequency Response – Quad Speed				
Passband	0		0.2083	Fs

Stopband	0.7917			Fs
Passband Ripple			±0.005	dB
Stopband Attenuation	70			dB
Analog Input				
Full Scale Input Level		AVDD/3.3		Vrms
Input Impedance		6		KΩ

DC CHARACTERISTICS

PARAMETER	MIN	TYP	MAX	UNIT
Normal Operation Mode (Fs=16 KHz)				
VDDD=1.8V, VDDP=1.8V, VDDA=3.3V		63		mW
VDDD=1.8V, VDDP=1.8V, VDDA=1.8V		24		
Power Down Mode				
VDDD=1.8V, VDDP=1.8V, VDDA=3.3V		10		uA
Digital Voltage Level				
Input High-level Voltage	0.7*VDDP			V
Input Low-level Voltage			0.5	V
Output High-level Voltage		VDDP		V
Output Low-level Voltage		0		V

SERIAL AUDIO PORT SWITCHING SPECIFICATIONS

PARAMETER	Symbol	MIN	MAX	UNIT
MCLK frequency			51.2	MHz
MCLK duty cycle		40	60	%
LRCK frequency			200	KHz
LRCK duty cycle		40	60	%
SCLK frequency			26	MHz
SCLK pulse width low	T _{SCLKL}	15		ns
SCLK Pulse width high	T _{SCLKH}	15		ns
SCLK falling to LRCK edge	T _{SLR}	-10	10	ns
SCLK falling to SDOUT valid	T _{SDO}	11		ns

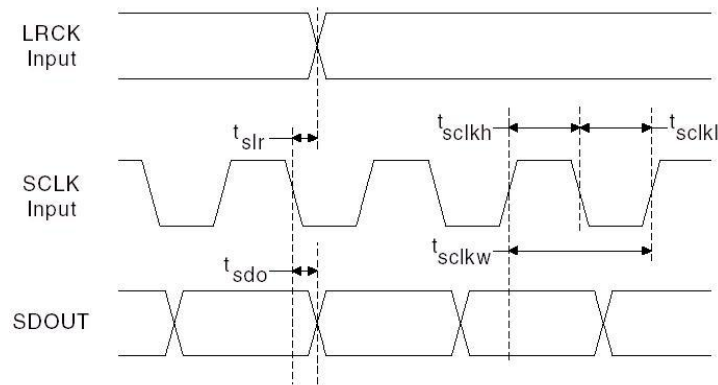
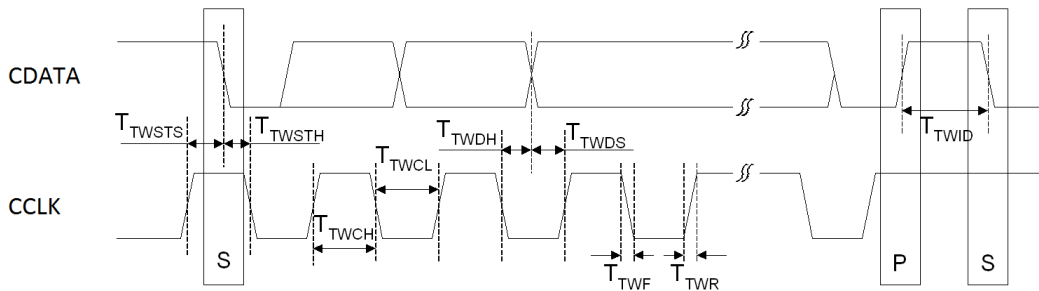

Figure 3 Serial Audio Port Timing

I²C SWITCHING SPECIFICATIONS

PARAMETER	Symbol	MIN	MAX	UNIT
CCLK Clock Frequency	F _{CCLK}		400	KHz
Bus Free Time Between Transmissions	T _{TWID}	1.3		us
Start Condition Hold Time	T _{TWSTH}	0.6		us
Clock Low time	T _{TWCL}	1.3		us
Clock High Time	T _{TWCH}	0.4		us
Setup Time for Repeated Start Condition	T _{TWSTS}	0.6		us
CDATA Hold Time from CCLK Falling	T _{TWDH}		900	ns
CDATA Setup time to CCLK Rising	T _{TWDS}	100		ns
Rise Time of CCLK	T _{TWR}		300	ns
Fall Time CCLK	T _{TWF}		300	ns

Figure 4 I²C Timing

8. CORPORATE INFORMATION

Everest Semiconductor Co., Ltd.

No. 1355 Jinjihu Drive, Suzhou Industrial Park, Jiangsu, P.R. China, Zip Code 215021

苏州工业园区金鸡湖大道 1355 号国际科技园, 邮编 215021

Email: info@everest-semi.com



X-ON Electronics

Largest Supplier of Electrical and Electronic Components

Click to view similar products for [Interface - CODECs](#) category:

Click to view products by [Everest Semiconductor](#) manufacturer:

Other Similar products are found below :

[CS4205-KQZ](#) [WM8944BECS/R](#) [TSCS42A2X1NLGIZAX](#) [DA7219-02VBA](#) [BU92001KN-E2](#) [TLC320AD52CPT](#) [WM8998ECS/R](#)
[CS42L73-CRZR](#) [STA529Q](#) [TLV320AIC14IDBT](#) [TLV320AIC23BIPWRQ1](#) [TLV320AIC23IPW](#) [TLV320AIC34IZASR](#)
[TLV320AIC3262IYZFR](#) [SGTL5000XNLA3R2](#) [MAX98089ETN+T](#) [TLV320DAC3203IRGER](#) [DA7212-01UM2](#) [WM8904CGEFL/RV](#)
[6PAIC3106IRGZRQ1](#) [CS42436-DMZ](#) [TSCS25A3X1NDGXZAX](#) [LE58QL063HVC](#) [ISD17120PY](#) [SSM2167-1RMZ](#) [HT34118ANZ](#)
[AD1835AASZ](#) [ADAU1961WBCPZ-R7](#) [AD1938WBSTZ](#) [AD1938WBSTZ-RL](#) [WM8904CGEFL/V](#) [WM8994ECS/R](#) [CS4207-CNZ](#) [CS4234-ENZ](#) [CS42416-CQZ](#) [CS42426-CQZ](#) [CS42432-CMZ](#) [CS42432-DMZ](#) [CS42438-CMZ](#) [CS42448-CQZ](#) [CS42448-DQZ](#) [CS4244-CNZ](#) [CS4244-DNZ](#) [CS4245-CQZ](#) [CS42516-CQZ](#) [CS42526-CQZ](#) [CS42528-CQZ](#) [CS4265-CNZ](#) [CS4270-CZZ](#) [CS4270-CZZR](#)