



## Technical Data Sheet

### Chip LED with Right Angle Lens

#### 12-215/GHC-YR1S2/3C

#### Features

- Package in 8mm tape on 7" diameter reel.
- Compatible with automatic placement equipment.
- Compatible with infrared and vapor phase reflow solder process.
- Mono-color type.
- Pb-free.
- The product itself will remain within RoHS compliant version.

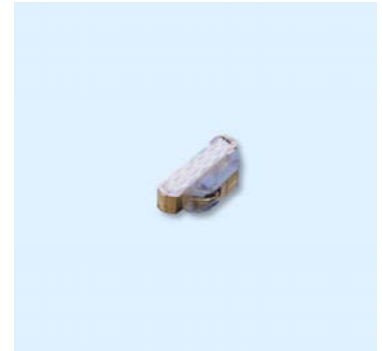

#### Descriptions

- The 12-215 SMD Taping is much smaller than lead frame type components, thus enable smaller board size, higher packing density, reduced storage space and finally smaller equipment to be obtained.
- Besides, lightweight makes them ideal for miniature applications. etc.

#### Applications

- Automotive: backlighting in dashboard and switch.
- Telecommunication: indicator and backlighting in telephone and fax.
- Flat backlight for LCD, switch and symbol.
- General use.

#### Device Selection Guide

Part No.	Chip		Lens Color
	Material	Emitted Color	
12-215/GHC-YR1S2/3C	InGaN	Brilliant Green	Water Clear

**Package Outline Dimensions**

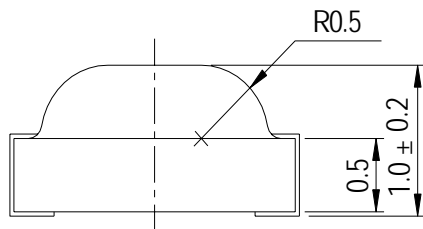
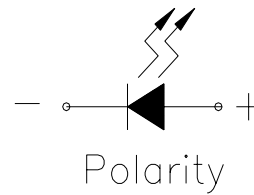
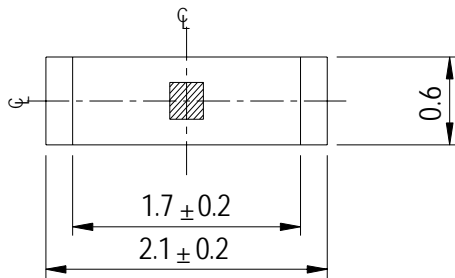

For reflow soldering (Propose)

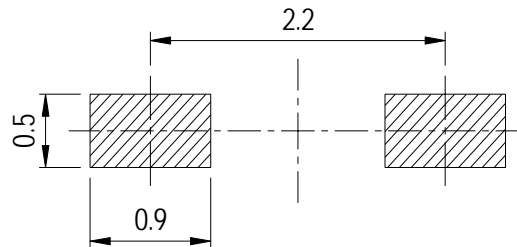
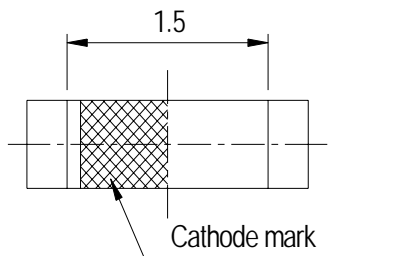

**Note:** The tolerances unless mentioned is  $\pm 0.1\text{mm}$  ,Unit = mm

**12-215/GHC-YR1S2/3C**
**Absolute Maximum Ratings (Ta=25°C)**

Parameter	Symbol	Rating	Unit
Reverse Voltage	V <sub>R</sub>	5	V
Forward Current	I <sub>F</sub>	25	mA
Operating Temperature	T <sub>opr</sub>	-40 ~ +85	°C
Storage Temperature	T <sub>stg</sub>	-40 ~ +90	°C
Electrostatic Discharge	ESD	150	V
Power Dissipation	P <sub>d</sub>	110	mW
Peak Forward Current (Duty 1/10 @1KHz)	I <sub>FP</sub>	100	mA
Soldering Temperature	T <sub>sol</sub>	Reflow Soldering : 260 °C for 10 sec. Hand Soldering : 350 °C for 3 sec.	

**Electro-Optical Characteristics (Ta=25°C)**

Parameter	Symbol	Min.	Typ.	Max.	Unit	Condition
Luminous Intensity	I <sub>v</sub>	112	-----	285	mcd	I <sub>F</sub> =20mA
Peak Wavelength	λ <sub>p</sub>	----	518	----	nm	
Dominant Wavelength	λ <sub>d</sub>	520	-----	535	nm	
Spectrum Radiation Bandwidth	Δλ	----	35	----	nm	
Viewing Angle	2θ 1/2	----	130	----	deg	
Forward Voltage	V <sub>F</sub>	2.7	3.3	3.7	V	
Reverse Current	I <sub>R</sub>	----	----	50	μA	V <sub>R</sub> =5V

**Notes:**

- 1.Tolerance of Luminous Intensity ±10%**
- 2.Tolerance of Dominant Wavelength ±1nm**
- 3.Tolerance of Forward Voltage ±0.10V**

**12-215/GHC-YR1S2/3C****Bin Range Of Dom. Wavelength**

Groups	Bin	Min	Max	Unit	Condition
Y	X	520	525	nm	IF=20mA
	Y	525	530		
	Z	530	535		

**Bin Range Of Luminous Intensity**

Bin	Min	Max	Unit	Condition
R1	112	140	mcd	IF=20mA
R2	140	180		
S1	180	225		
S2	225	285		

**Notes:**

- 1.Tolerance of Luminous Intensity  $\pm 10\%$
- 2.Tolerance of Dominant Wavelength  $\pm 1\text{nm}$
- 3.Tolerance of Forward Voltage  $\pm 0.10\text{V}$

**Typical Electro-Optical Characteristics Curves**

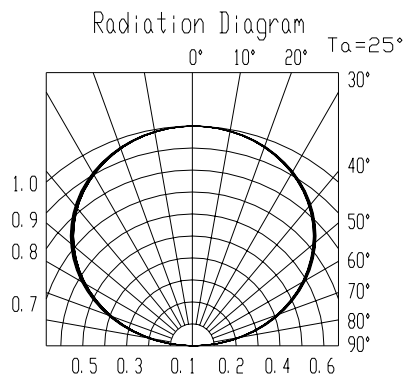
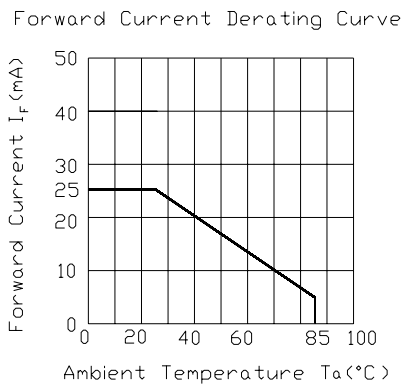
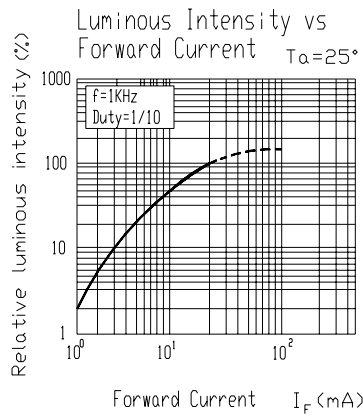
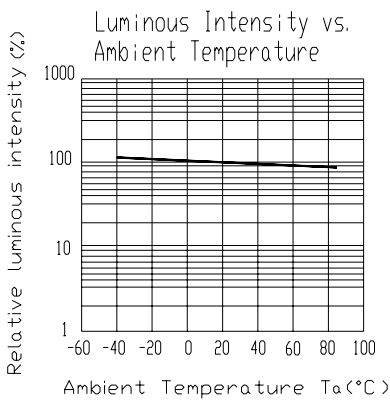
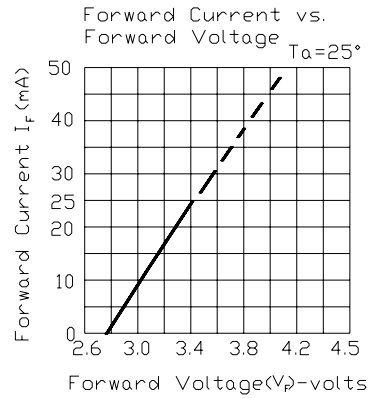
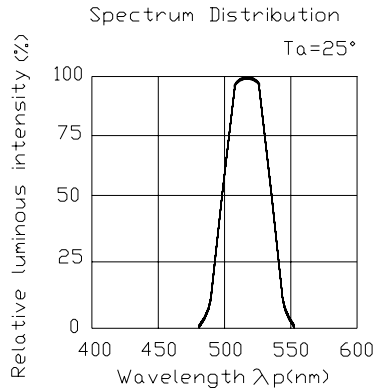

**12-215/GHC-YR1S2/3C**

**Label explanation**

**CAT: Luminous Intensity Rank**

**HUE: Dom. Wavelength Rank**

**REF: Forward Voltage Rank**

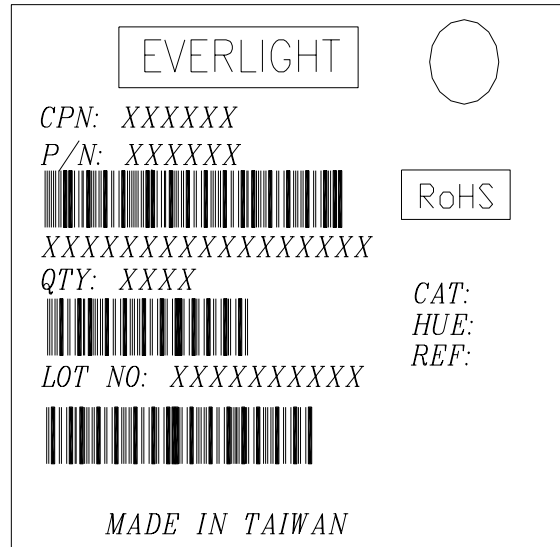

**Reel Dimensions**

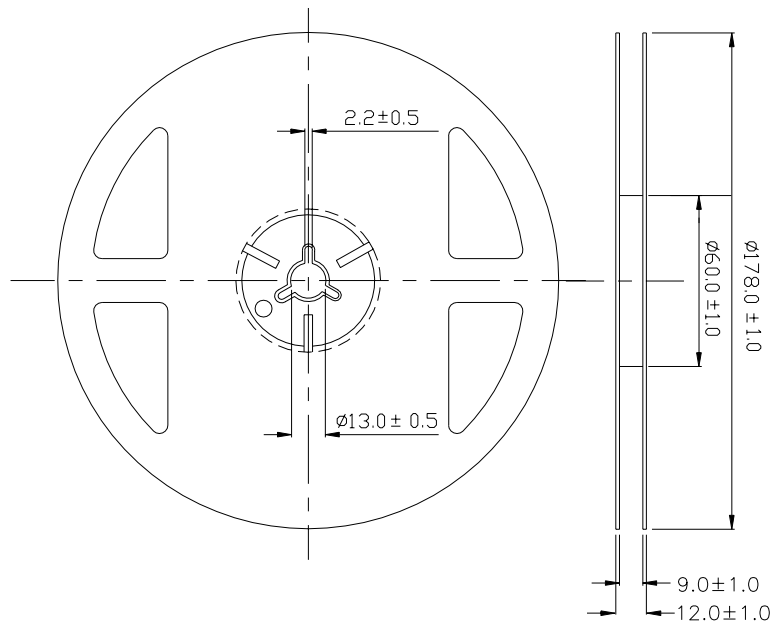

**Note:** The tolerances unless mentioned is  $\pm 0.1\text{mm}$  ,Unit = mm

**Carrier Tape Dimensions: Loaded quantity 3000 PCS per reel**

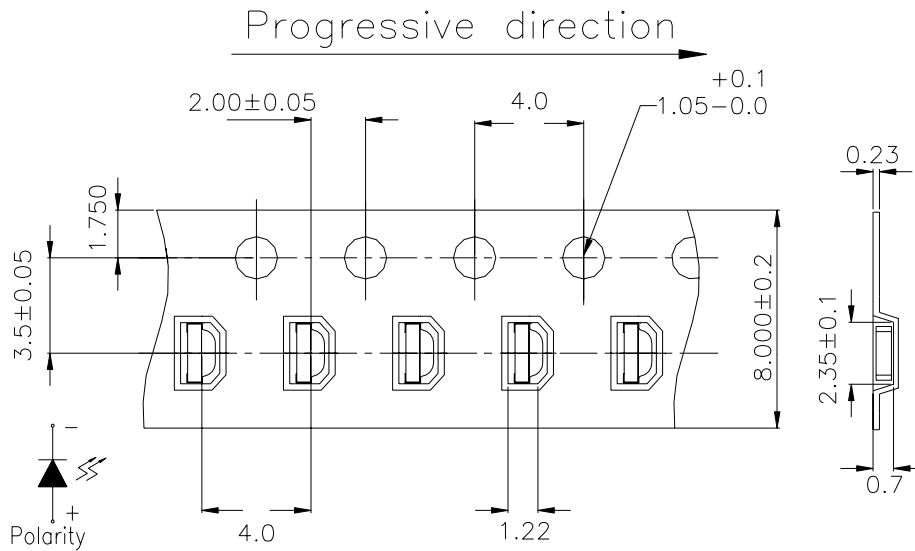

**Note:** The tolerances unless mentioned is  $\pm 0.1$ mm ,Unit = mm

**Moisture Resistant Packaging**

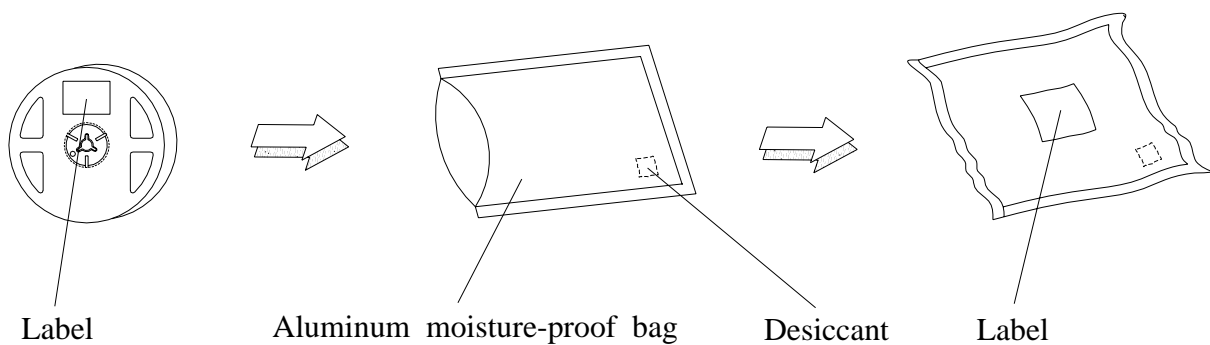

**Reliability Test Items And Conditions**

The reliability of products shall be satisfied with items listed below.

Confidence level : 90%

LTPD : 10%

No.	Items	Test Condition	Test Hours/Cycles	Sample Size	Ac/Re
1	Reflow Soldering	Temp. : 260°C ±5°C 5sec.	6 Min.	22 PCS.	0/1
2	Temperature Cycle	H : +100°C 15min ∫ 5 min L : -40°C 15min	300 Cycles	22 PCS.	0/1
3	Thermal Shock	H : +100°C 5min ∫ 10 sec L : -10°C 5min	300 Cycles	22 PCS.	0/1
4	High Temperature Storage	Temp. : 100°C	1000 Hrs.	22 PCS.	0/1
5	Low Temperature Storage	Temp. : -40°C	1000 Hrs.	22 PCS.	0/1
6	DC Operating Life	IF = 20 mA	1000 Hrs.	22 PCS.	0/1
7	High Temperature / High Humidity	85°C / 85%RH	1000 Hrs.	22 PCS.	0/1



**Precautions For Use**

1. Over-current-proof

Customer must apply resistors for protection , otherwise slight voltage shift will cause big current change ( Burn out will happen ).

2. Storage

2.1 Do not open moisture proof bag before the products are ready to use.

2.2 Before opening the package, the LEDs should be kept at 30°C or less and 90%RH or less.

2.3 The LEDs should be used within a year.

2.4 After opening the package, the LEDs should be kept at 30°C or less and 60%RH or less.

2.5 The LEDs should be used within 168 hours (7 days) after opening the package.

2.6 If the moisture absorbent material (silica gel) has faded away or the LEDs have exceeded the storage time, baking treatment should be performed using the following conditions.

Baking treatment : 60±5°C for 24 hours.

3. Soldering Condition

3.1 Pb-free solder temperature profile

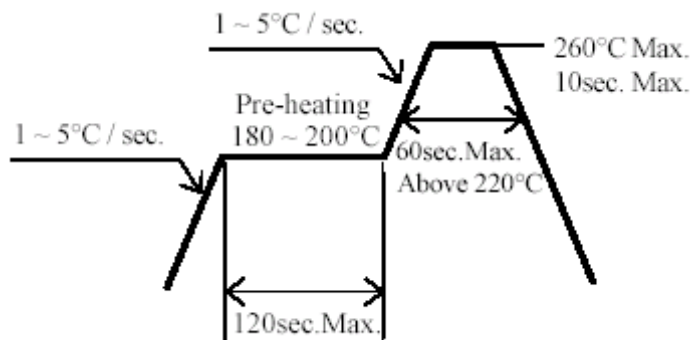

3.2 Reflow soldering should not be done more than two times.

3.3 When soldering, do not put stress on the LEDs during heating.

3.4 After soldering, do not warp the circuit board.

#### 4. Soldering Iron

Each terminal is to go to the tip of soldering iron temperature less than 350°C for 3 seconds within once in less than the soldering iron capacity 25W. Leave two seconds and more intervals, and do soldering of each terminal. Be careful because the damage of the product is often started at the time of the hand solder.

#### 5.Repairing

Repair should not be done after the LEDs have been soldered. When repairing is unavoidable, a double-head soldering iron should be used (as below figure). It should be confirmed beforehand whether the characteristics of the LEDs will or will not be damaged by repairing.

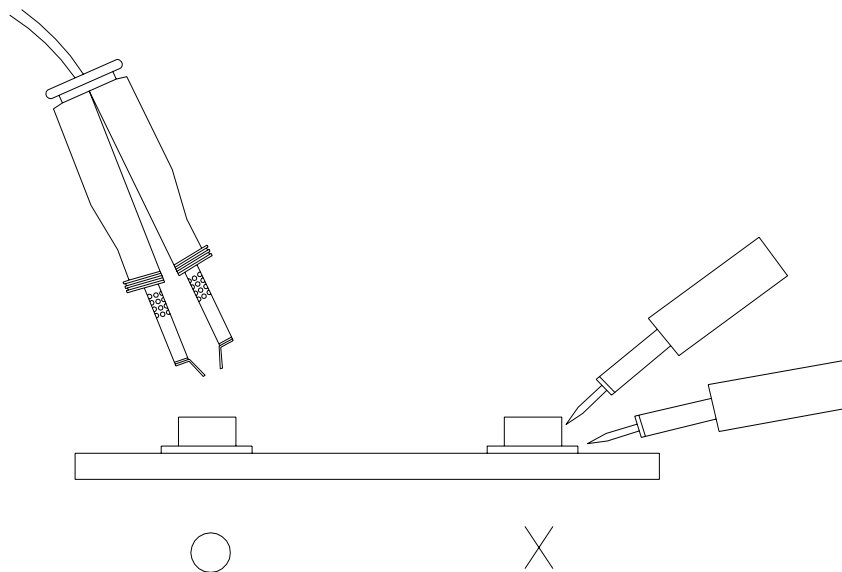

**EVERLIGHT ELECTRONICS CO., LTD.**

Office: No 25, Lane 76, Sec 3, Chung Yang Rd,  
Tucheng, Taipei 236, Taiwan, R.O.C

Tel: 886-2-2267-2000, 2267-9936

Fax: 886-2267-6244, 2267-6189, 2267-6306

<http://www.everlight.com>

## X-ON Electronics

Largest Supplier of Electrical and Electronic Components

*Click to view similar products for [Everlight manufacturer](#):*

Other Similar products are found below :

[12-215/GHC-YR1S2/3C](#) [H11L1STA](#) [QTLP600C4TR](#) [IRM-6638M3](#) [EL-17-21SURC/S530-A2/TR8](#) [QTLP651C4TR](#) [MAN6760](#) [ELSW-F41Y1-OLPNM-AA3A5](#) [HLMPM501](#) [ITR-20002](#) [PLR135/T8](#) [SIR67-21/TR8](#) [SIR91-21C/TR10](#) [61-238/LK2C-B50638F6GB2/ET](#) [ELSW-F71M1-0CPHS-C3000](#) [24-21/BHC-AP1Q2/2A](#) [HLMP1719](#) [MV64521](#) [EL816\(B\)\(ETN\)-F](#) [11-21/T3D-AQ1R1QY/2T](#) [PLR135/T9](#) [MV53123](#) [IRM-3638C/TR1-11](#) [204-10SUBC/S400-A4-L](#) [H11L1M](#) [EL817M\(B\)\(TH\)-F](#) [EL817M\(C\)-FG](#) [PT204-6B-27](#) [19-117/BHC-ZM1N2QY/3T](#) [11-21UYOC/S530-A3/TR8](#) [IR333-F/H0-A](#) [LKPT30102B-A01\(DY\)](#) [45-21S/KK2C-H3030L9N32733Z6/2T\(SW\)](#) [HLMP1440](#) [EL-PT15-21C](#) [ELSH-F41R1-OLPNM-AR5R6](#) [EL1017\(TA\)-VG](#) [MV60539MP7](#) [QTLP600C2TR](#) [12-22/S2G6C-C30/2C](#) [333-2SUBC/S400-A4](#) [IRM-3638MF56](#) [EL2601](#) [91-21SURC/S530-A3/TR10](#) [12-215SYGC/S530-E2/TR8](#) [19-213UYC/S530-A2/TR8](#) [6N137M](#) [27-21/GHC-YR1S2/3C](#) [15-215SYGC/S530-E1/TR8](#) [12-21CSUBP/S576/TR8](#)