



# Technical Data Sheet

## Right Angle Lens Chip LEDs with Bi-Color (Multi-Color)

### 12-22/S2ST3D-C30/2C

#### Features

- Package in 8mm tape on 7" diameter reel.
- Compatible with automatic placement equipment.
- Compatible with infrared and vapor phase reflow solder process.
- Multi-color type.
- Pb-free.
- The product itself will remain within RoHS compliant version.



#### Descriptions

- The 12-22 SMD LED is much smaller than lead frame type components, thus enable smaller board size, higher packing density, reduced storage space and finally smaller equipment to be obtained.
- Besides, lightweight makes them ideal for miniature applications. etc.

#### Applications

- Backlighting in dashboard and switch.
- Telecommunication: indicator and backlighting in telephone and fax.
- Flat backlight for LCD, switch and symbol.
- General use.

CONFIDENTIAL

#### Device Selection Guide

Chip		Emitted Color	Resin Color
Type	Material		
S2S	AlGaInP	Brilliant Orange	Yellow Diffused
T3	InGaN	Pure White	

**Package Outline Dimensions**

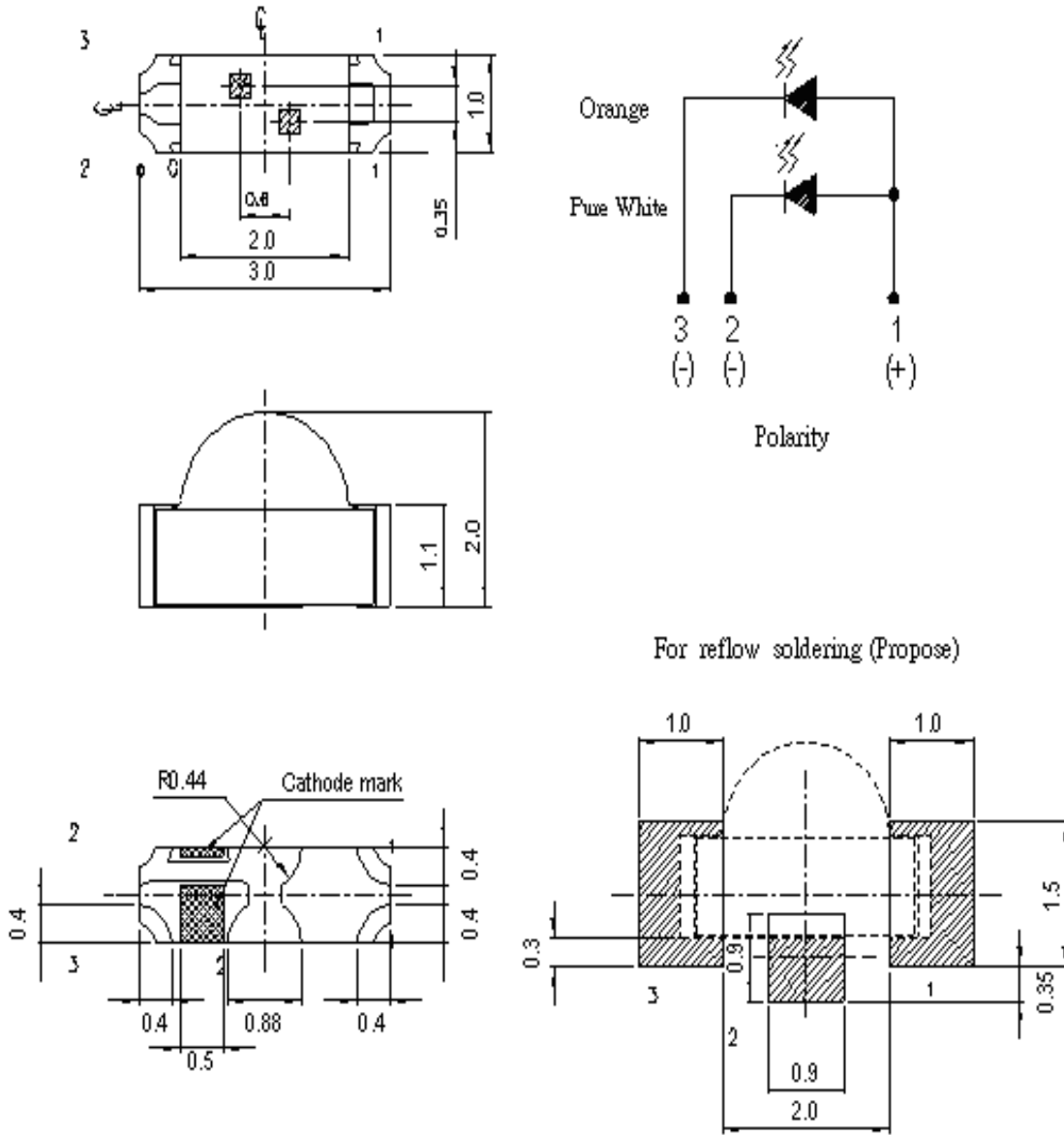

**Note:** The tolerances unless mentioned is  $\pm 0.1\text{mm}$  ,Unit = mm

**12-22/S2ST3D-C30/2C****Absolute Maximum Ratings (Ta=25 )**

Parameter	Symbol	Rating	Unit
Reverse Voltage	V <sub>R</sub>	5	V
Forward Current	I <sub>F</sub>	S2S:50 T3:25	mA
Peak Forward Current (Duty 1/10 @1KHz)	I <sub>FP</sub>	S2S:100 T3:100	mA
Power Dissipation	P <sub>d</sub>	S2S:120 T3:95	mW
Electrostatic Discharge (HBM)	ESD	S2S:2000 T3:150	V
Operating Temperature	Topr	-40 ~ +85	
Storage Temperature	Tstg	-40 ~ +90	
Soldering Temperature	Tsol	Reflow Soldering : 260 for 10 sec. Hand Soldering : 350 for 3 sec.	

CONFIDENTIAL

**Electro-Optical Characteristics (Ta=25 )**

Parameter	Symbol	Min.	Typ.	Max.	Unit	Condition
Luminous Intensity	I <sub>v</sub> S2S	18.0	----	45.0	mcd	I <sub>F</sub> =5mA
	T3	45.0	----	112		
Viewing Angle	2 1/2	-----	130	-----	deg	
Peak Wavelength	λ <sub>p</sub> S2S	-----	611	-----	nm	
	T3	-----	-----	-----		
Dominant Wavelength	λ <sub>d</sub> S2S	-----	605	-----	nm	
	T3	-----	-----	-----		
Spectrum Radiation Bandwidth	S2S	-----	17	-----	nm	
	T3	-----	35	-----		
Forward Voltage	V <sub>F</sub> S2S	1.7	2.0	2.4	V	
	T3	2.7	3.3	3.7		
Reverse Current	I <sub>R</sub> S2S	-----	-----	10	μ A	V <sub>R</sub> =5V
	T3	-----	-----	50		

**Notes:**
**1.Tolerance of Luminous Intensity ±11%**

CONFIDENTIAL



**S2S**

**Bin Range Of Luminous Intensity**

Bin	Min	Max	Unit	Condition
M	18.0	28.5	mcd	I <sub>F</sub> =5mA
N	28.5	45.0		

**T3**

**Bin Range Of Luminous Intensity**

Bin	Min	Max	Unit	Condition
P	45.0	72.0	mcd	I <sub>F</sub> =5mA
Q	72.0	112		

**Notes:**

- 1.Tolerance of Luminous Intensity  $\pm 11\%$

CONFIDENTIAL

**Chromaticity Coordinates Specifications for Bin Grading**

Group	Bin Code	CIE_x	CIE_y	Condition
C	1	0.274	0.226	I <sub>F</sub> =5mA
		0.274	0.258	
		0.294	0.286	
		0.294	0.254	
	2	0.274	0.258	
		0.274	0.291	
		0.294	0.319	
		0.294	0.286	
	3	0.294	0.254	
		0.294	0.286	
		0.314	0.315	
		0.314	0.282	
	4	0.294	0.286	
		0.294	0.319	
		0.314	0.347	
		0.314	0.315	

## Notes:

- 1.The C.I.E. 1931 chromaticity diagram ( Tolerance  $\pm 0.01$ ).
- 2.The products are sensitive to static electricity and care must be fully taken when handling products.

**CIE Chromaticity Diagram**

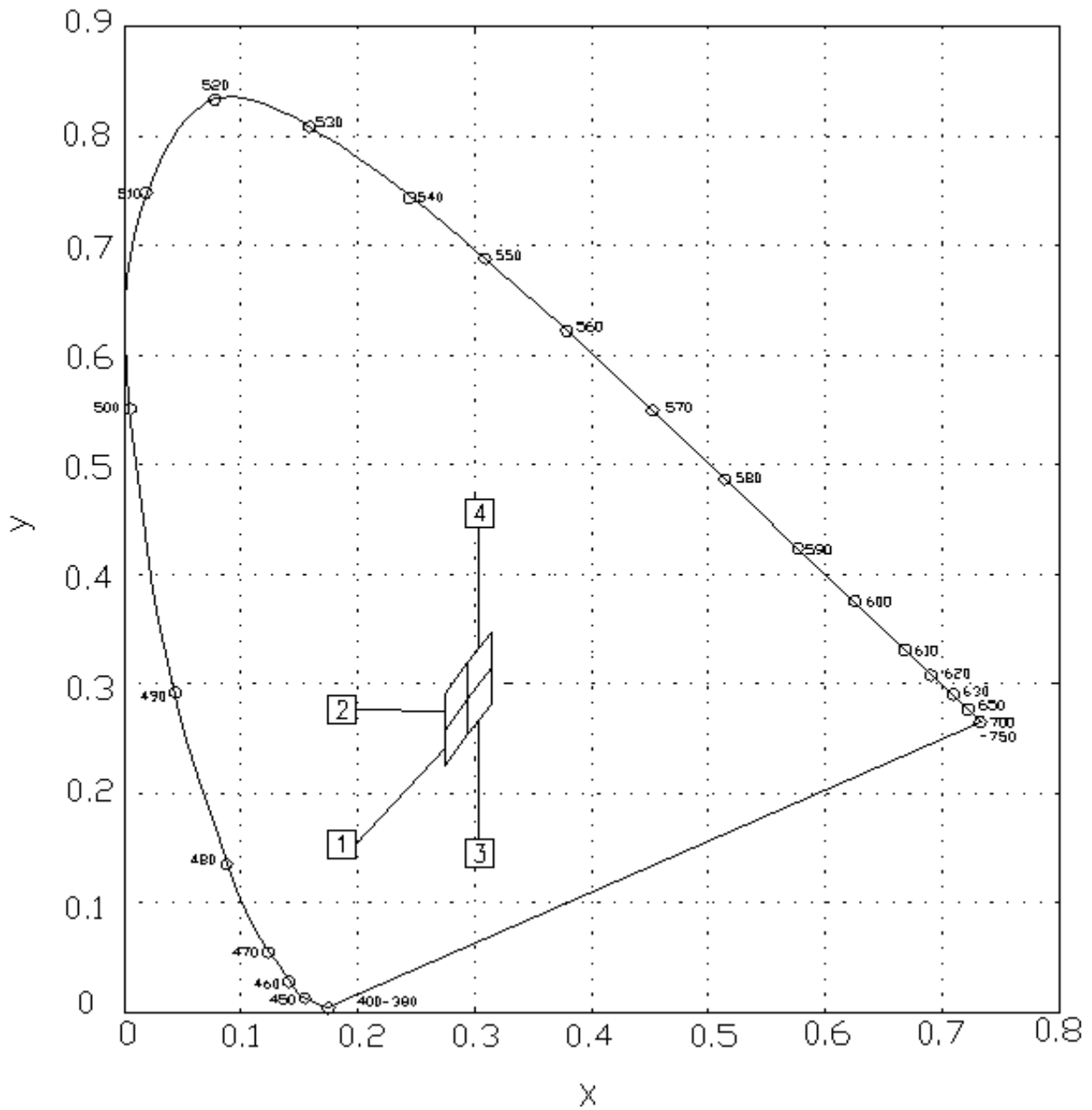

Typical Electro-Optical Characteristics Curves  
S2S

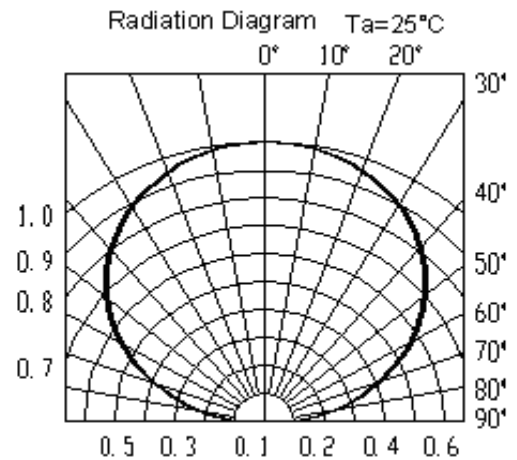
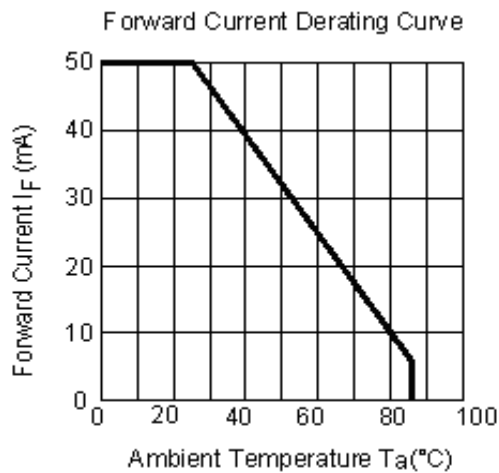
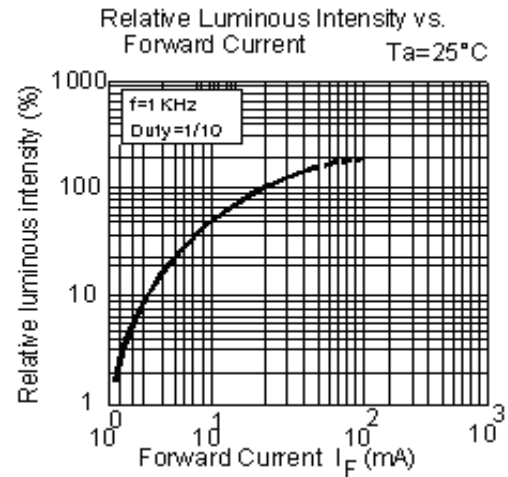
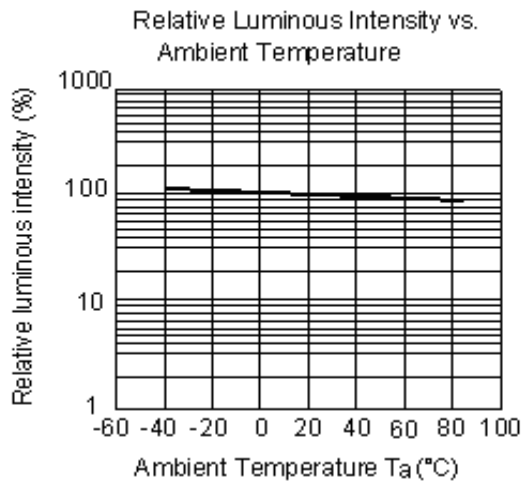
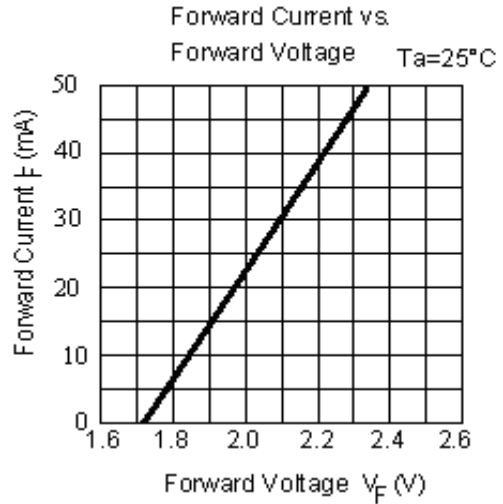
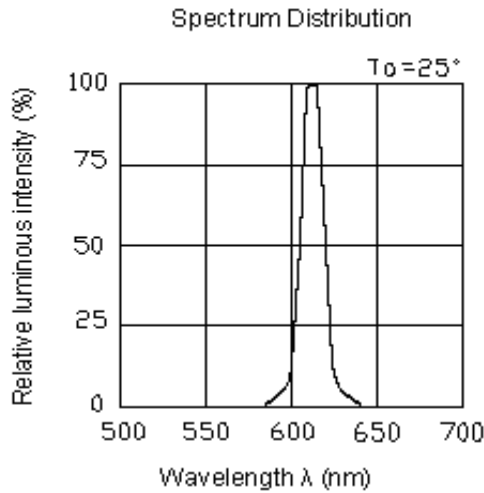



Typical Electro-Optical Characteristics Curves

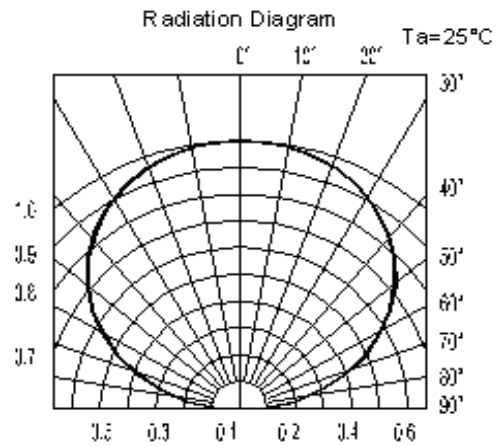
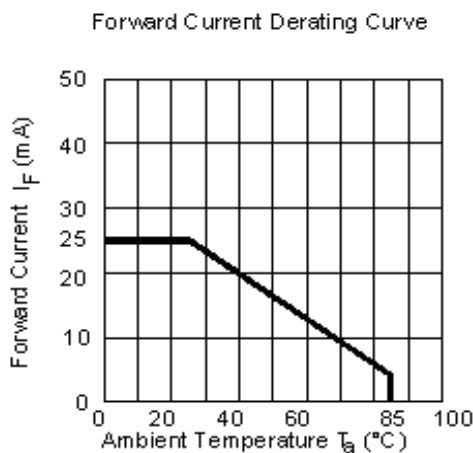
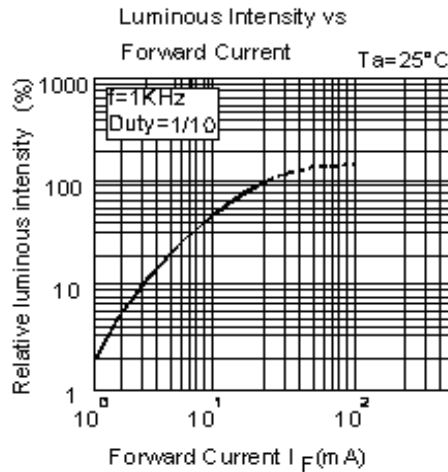
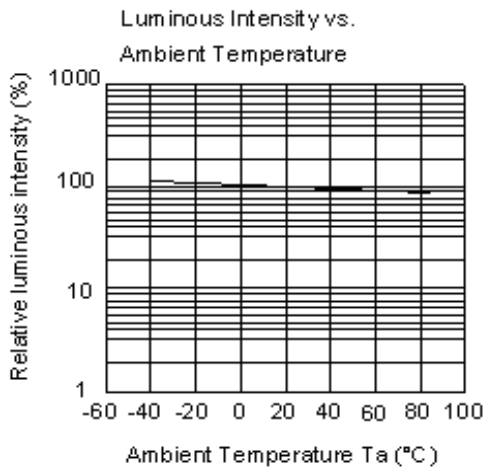
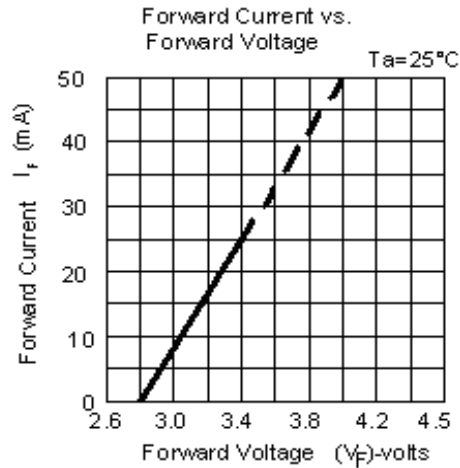
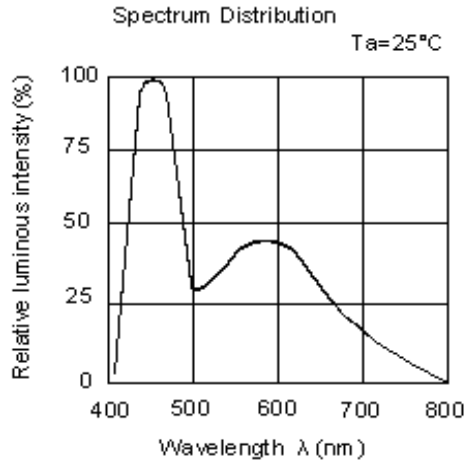

T3



**Label explanation**

**CAT: Luminous Intensity Rank    HUE: Chromaticity Coordinates    REF: Forward Voltage Rank**

EVERLIGHT

CPN :  
P/N: XXXXXXXXXXXX  
  
XX-XXXXXXXX  
QTY: XXXX  
  
LOT NO: XXXXXXXXXXXX  

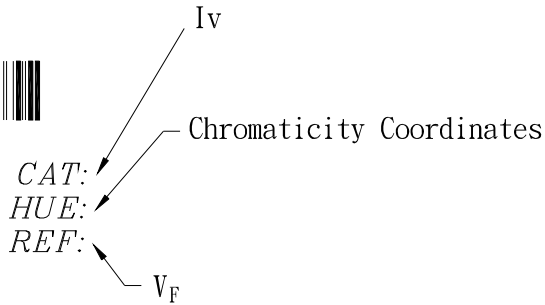

MADE IN TAIWAN

**Reel Dimensions**

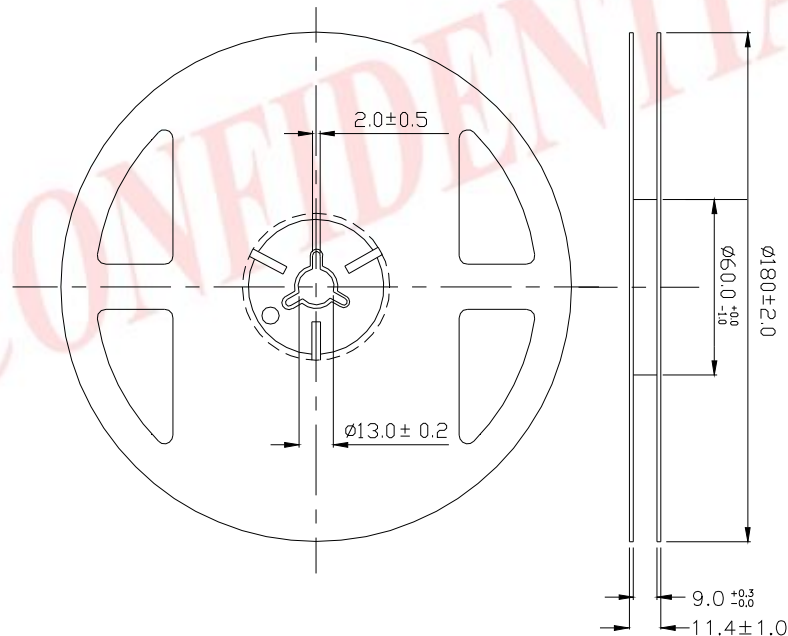

**Note:** The tolerances unless mentioned is  $\pm 0.1\text{mm}$  ,Unit = mm

**Carrier Tape Dimensions: Loaded quantity 2000 PCS per reel**

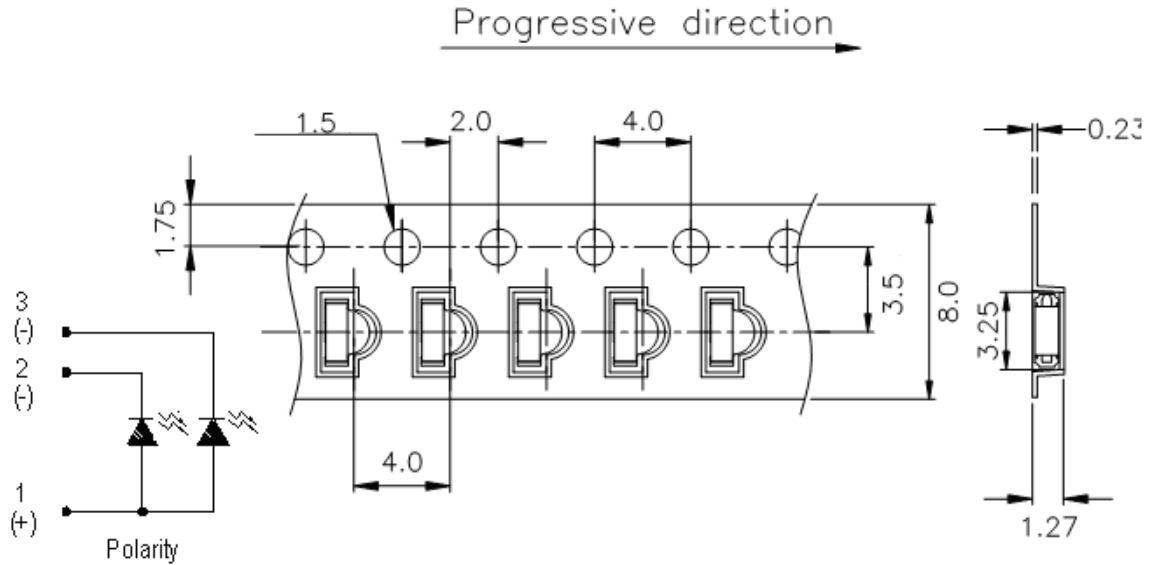

**Note:** The tolerances unless mentioned is  $\pm 0.1\text{mm}$  ,Unit = mm

**Moisture Resistant Packaging**

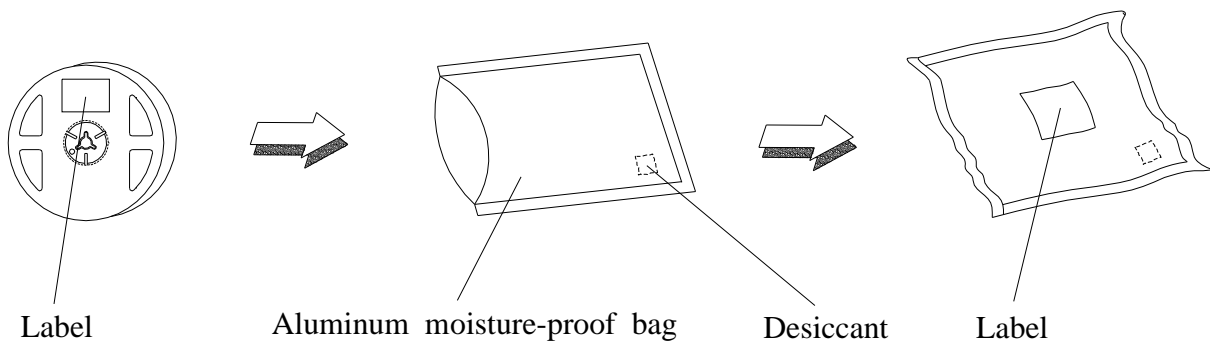

**Reliability Test Items And Conditions**

The reliability of products shall be satisfied with items listed below.

Confidence level : 90%

LTPD : 10%

No.	Items	Test Condition	Test Hours/Cycles	Sample Size	Ac/Re
1	Reflow Soldering	Temp. : 260 ±5 Min. 5sec.	6 Min.	22 PCS.	0/1
2	Temperature Cycle	H : +100 15min 5 min L : -40 15min	300 Cycles	22 PCS.	0/1
3	Thermal Shock	H : +100 5min 10 sec L : -10 5min	300 Cycles	22 PCS.	0/1
4	High Temperature Storage	Temp. : 100	1000 Hrs.	22 PCS.	0/1
5	Low Temperature Storage	Temp. : -40	1000 Hrs.	22 PCS.	0/1
6	DC Operating Life	I <sub>F</sub> = 20 mA	1000 Hrs.	22 PCS.	0/1
7	High Temperature / High Humidity	85 / 85%RH	1000 Hrs.	22 PCS.	0/1

**Precautions For Use**

1. Over-current-proof

Customer must apply resistors for protection, otherwise slight voltage shift will cause big current change ( Burn out will happen ).

2. Storage

2.1 Do not open moisture proof bag before the products are ready to use.

2.2 Before opening the package: The LEDs should be kept at 30 or less and 90%RH or less.

2.3 After opening the package: The LED's floor life is 1 year under 30 or less and 60% RH or less.

If unused LEDs remain, it should be stored in moisture proof packages.

2.4 If the moisture absorbent material (silica gel) has faded away or the LEDs have exceeded the storage time, baking treatment should be performed using the following conditions.

Baking treatment : 60±5 for 24 hours.

3. Soldering Condition

3.1 Pb-free solder temperature profile

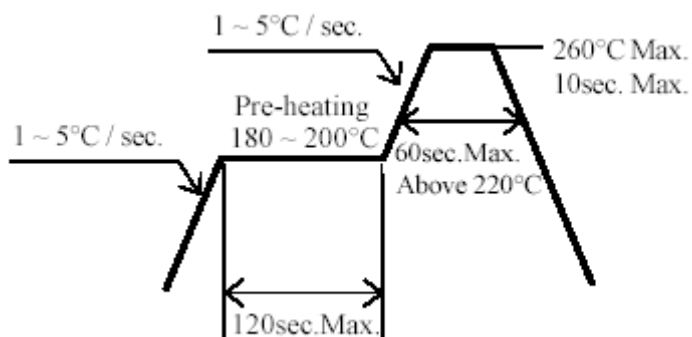

CONFIDENTIAL

3.2 Reflow soldering should not be done more than two times.

3.3 When soldering, do not put stress on the LEDs during heating.

3.4 After soldering, do not warp the circuit board.

#### 4.Soldering Iron

Each terminal is to go to the tip of soldering iron temperature less than 350 for 3 seconds within once in less than the soldering iron capacity 25W. Leave two seconds and more intervals, and do soldering of each terminal. Be careful because the damage of the product is often started at the time of the hand solder.

#### 5.Repairing

Repair should not be done after the LEDs have been soldered. When repairing is unavoidable, a double-head soldering iron should be used (as below figure). It should be confirmed beforehand whether the characteristics of the LEDs will or will not be damaged by repairing.

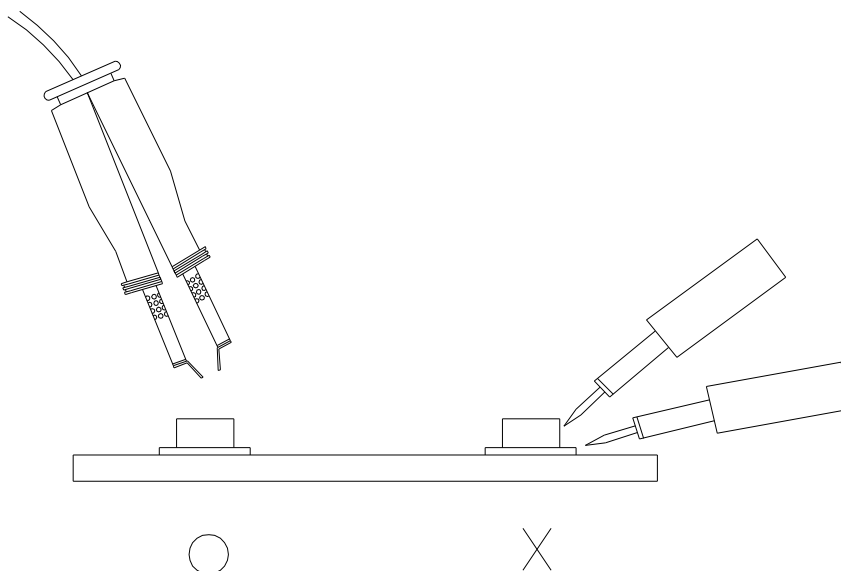

**EVERLIGHT ELECTRONICS CO., LTD.**  
Office: No 25, Lane 76, Sec 3, Chung Yang Rd,  
Tucheng, Taipei 236, Taiwan, R.O.C

Tel: 886-2-2267-2000, 2267-9936  
Fax: 886-2267-6244, 2267-6189, 2267-6306  
<http://www.everlight.com>

## X-ON Electronics

Largest Supplier of Electrical and Electronic Components

*Click to view similar products for [Standard LEDs - SMD category](#):*

*Click to view products by [Everlight manufacturer](#):*

Other Similar products are found below :

[LTST-C190KYKT](#) [LTST-C19GD2WT](#) [LTST-N683GBEW](#) [LTW-170ZDC](#) [LTW-M140SZS40](#) [598-8110-100F](#) [598-8170-100F](#) [598-8610-202F](#) [AAAF5060QBFSEEZGS](#) [HLMA-QG00-S0021](#) [ALMD-LB36-SV002](#) [APT1608QGW](#) [EAST2012YA0](#) [EASV1803BA0](#) [LG M67K-H1J2-24-0-2-R18-Z](#) [SML-512VWT86A](#) [SML-LX0606SISUGC/A](#) [SML-LXL1307SRC-TR](#) [SML-LXR851SIUPGUBC](#) [LT1ED53A](#) [AM27ZGC03](#) [APB3025SGNC](#) [APFA3010SURKCGKQBDC](#) [APHK1608VGCA](#) [CLX6D-FKB-CN1R1H1BB7D3D3](#) [LTST-008BGEW](#) [LTST-C250KGKT](#) [LTW-010DCG](#) [LTW-020ZDCG](#) [LTW-21TS5](#) [LTW-220DS5](#) [598-8330-117F](#) [SML-LX0402IC-TR](#) [CMDA20AYAA7D1S](#) [CMDA16AYDR7A1X](#) [91-21SYGD/S530-E2/TR7](#) [HSMQ-C177](#) [598-8040-100F](#) [598-8070-100F](#) [598-8140-100F](#) [598-8610-200F](#) [EAST2012GA0](#) [EAPL3527GA5](#) [SML-LXL1209SYC/ATR](#) [EAST2012RA0](#) [EAST1608RGBAA0](#) [CMD91-21VRC/TR7](#) [SML-LXR851SGSIC-TR](#) [SML-512PWT86A](#) [SMF-2432GYC-TR](#)