



# Technical Data Sheet

## 3.0mm Multi-Color Round Type LED Lamps

### 1259-7UYSYGW/S530-A3

#### ■ Features :

- Two chips are matched for uniform light output, wide viewing angle
- Long life-solid state reliability
- I.C. compatible/Low power consumption
- Pb free
- The product itself will remain within RoHS compliant version

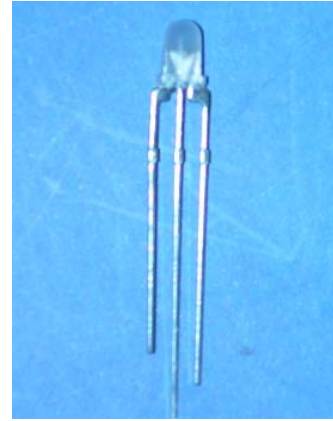

#### ■ Descriptions :

- The 1259-7LED lamps contain two integral chips and is available as both bicolor and bipolar types.
- Super Yellow and Super Yellow Green light is emitted by diodes of AlGaInP and AlGaInP
- Type of bicolor lamps are both white diffused and color diffused while the bicolor are water clear.

#### ■ Applications :

- TV set
- Monitor
- Telephone
- Computer

PART NO.	Chip		Lens Color
	Material	Emitted Color	
1259-7UYSYGW/S530-A3	AlGaInP	Super Yellow	White Diffused
	AlGaInP	Super Yellow Green	



Technical Data Sheet  
3.0mm Multi-Color Round Type LED Lamps

1259-7UYSYGW/S530-A3

Package Dimensions

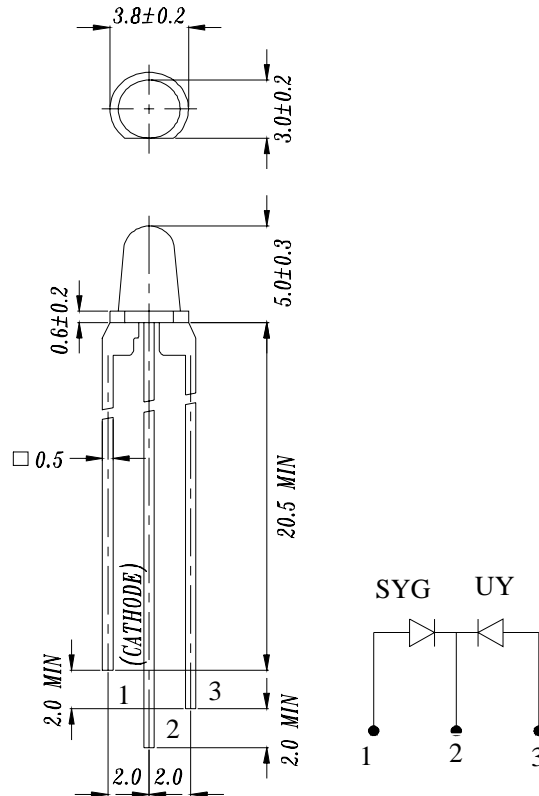

- Notes: 1. All dimensions are in millimetres  
2. An epoxy meniscus may extend about 1.5mm(0.059") down to the lead.  
3. Tolerances unless Dimension  $\pm 0.25$ mm.

■ Absolute Maximum Ratings at  $T_a = 25^\circ\text{C}$

Parameter	Symbol	Rating		Unit
		UY/S530	SYG/S530	
Forward Current	I <sub>F</sub>	25	25	mA
Operating Temperature	T <sub>opr</sub>	-40 to +85		°C
Storage Temperature	T <sub>stg</sub>	-40 to +100		°C
Soldering Temperature	T <sub>sol</sub>	260 ± 5		°C
Electrostatic Discharge	ESD	2000	2000	V
Power Dissipation	P <sub>d</sub>	60	60	mW
Reverse Voltage	V <sub>R</sub>	5		V

Note: \*1: Soldering time  $\leq 5$  seconds.



Technical Data Sheet  
3.0mm Multi-Color Round Type LED Lamps

1259-7UYSYGW/S530-A3

Electro-Optical Characteristics (Ta=25°C)

Parameter	Symbol		Condition	Min.	Typ.	Max.	Unit
Forward Voltage	UY/S530	V <sub>F</sub>	I <sub>F</sub> = 20 mA	/	2.0	2.4	V
	SYG/S530			/	2.0	2.4	
Reverse Current	UY/S530	I <sub>R</sub>	V <sub>R</sub> = 5 V	/	/	10	μ A
	SYG/S530			/	/	10	
Luminous Intensity	UY/S530	I <sub>v</sub>	I <sub>F</sub> = 20 mA	63	125	/	mcd
	SYG/S530			40	80	/	
Viewing Angle		2θ 1/2	I <sub>F</sub> = 20 mA	/	40	/	deg
Peak Wavelength	UY/S530	λ <sub>p</sub>	I <sub>F</sub> = 20 mA	/	591	/	nm
	SYG/S530			/	575	/	
Dominant Wavelength	UY/S530	λ <sub>d</sub>	I <sub>F</sub> = 20 mA	/	589	/	nm
	SYG/S530			/	573	/	
Spectrum Radiation Bandwidth	UY/S530	Δλ	I <sub>F</sub> = 20 mA	/	15	/	nm
	SYG/S530			/	20	/	



# Technical Data Sheet

## 3.0mm Multi-Color Round Type LED Lamps

1259-7UYSYGW/S530-A3

### Typical Electro-Optical Characteristic Curves:

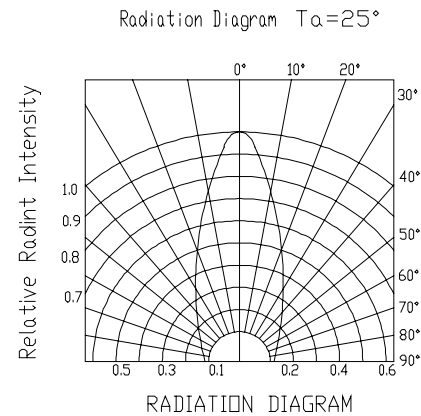
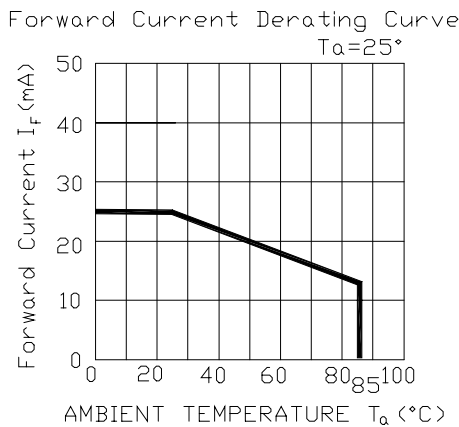
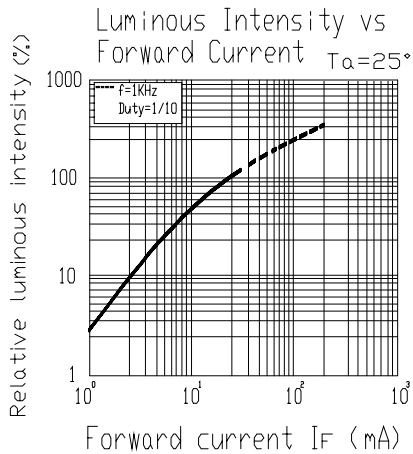
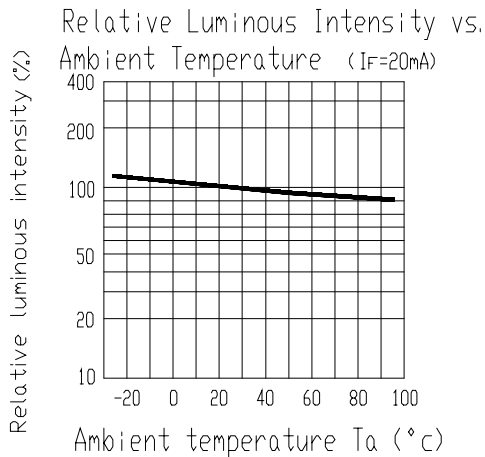
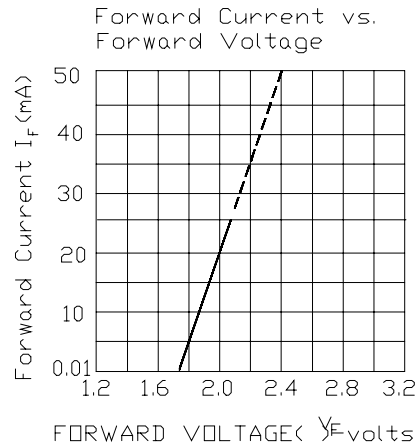
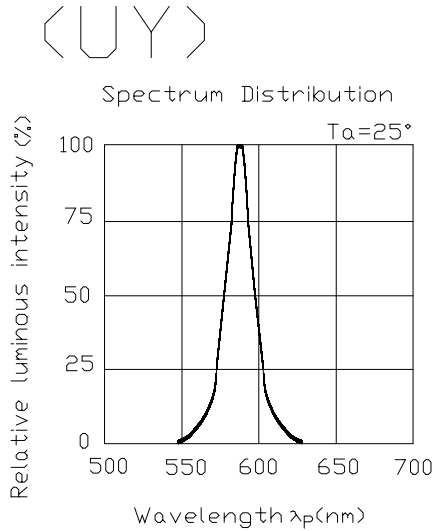



# Technical Data Sheet

## 3.0mm Multi-Color Round Type LED Lamps

1259-7UYSYGW/S530-A3

### Typical Electro-Optical Characteristic Curves:

(SYG)

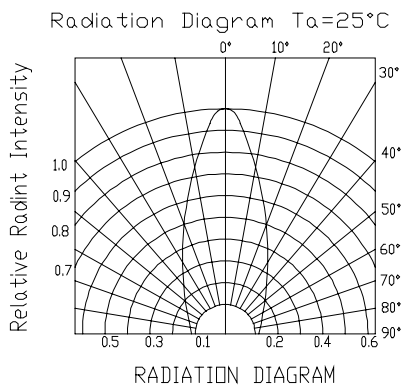
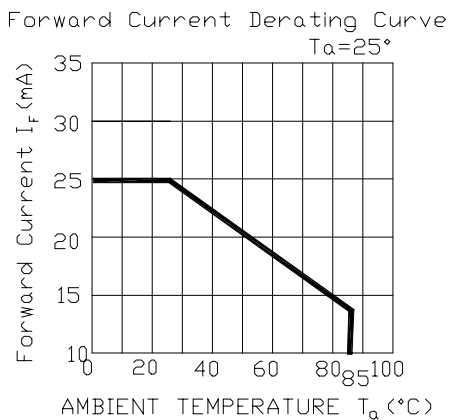
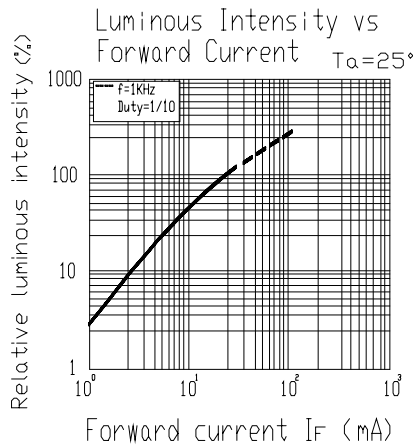
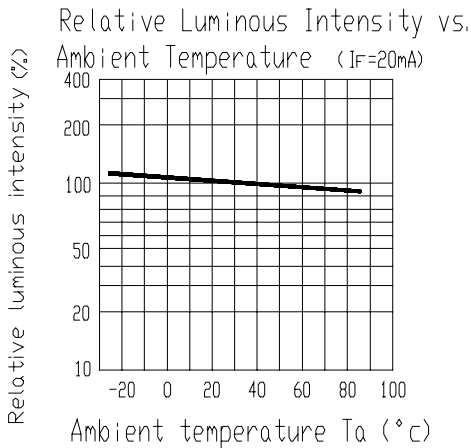
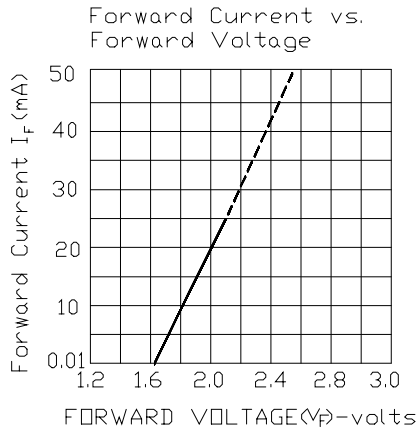
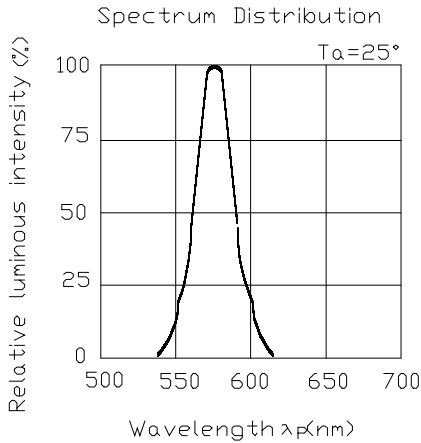



# Technical Data Sheet

## 3.0mm Multi-Color Round Type LED Lamps

1259-7UYSYGW/S530-A3

### ■ Reliability test items and conditions:

The reliability of products shall be satisfied with items listed below.

Confidence level : 97%

LTPD : 3%

NO	Item	Test Conditions	Test Hours/Cycle	Sample Size	Failure Judgment Criteria	Ac/Re
1	Solder Heat	TEMP : 260°C ± 5 °C	10 SEC	76 PCS	Iv ≤ Ivt*0.5 or Vf ≥ U or Vf ≤ L	0/1
2	Temperature Cycle	H : +100°C 15min ∫ 5 min L : -40°C 15min	300 CYCLES	76 PCS		0/1
3	Thermal Shock	H : +100°C 5min ∫ 10 sec L : -10°C 5min	300 CYCLES	76 PCS		0/1
4	High Temperature Storage	TEMP : 100°C	1000 HRS	76 PCS		0/1
5	Low Temperature Storage	TEMP : -40°C	1000 HRS	76 PCS		0/1
6	DC Operating Life	TEMP : 25°C I <sub>F</sub> = 20mA	1000 HRS	76 PCS		0/1
7	High Temperature / High Humidity	85°C / 85% RH	1000 HRS	76 PCS		0/1

Note : Ivt : To test Iv value of the chip before the reliability test  
Iv : The test value of the chip that has completed the reliability test  
U : Upper Specification Limit  
L : Lower Specification Limit



# Technical Data Sheet

## 3.0mm Multi-Color Round Type LED Lamps

1259-7UYSYGW/S530-A3

### Packing Quantity Specification

1.1000PCS/1Bag , 4Bags/1Box

2.10Boxes/1Carton

### Label Form Specification

EVERLIGHT

CPN:

P/N:



1259-7UYSYGW/S530-A3

QTY:



CAT:

HUE:

REF:

LOT NO: EL



CPN: Customer's Production Number

P/N : Production Number

QTY: Packing Quantity

CAT: Ranks

HUE: Dominant Wavelength

REF: Reference

LOT No: Lot Number

### Notes

1. Above specification may be changed without notice. EVERLIGHT will reserve authority on material change for above specification.
2. When using this product, please observe the absolute maximum ratings and the instructions for using outlined in these specification sheets. EVERLIGHT assumes no responsibility for any damage resulting from use of the product which does not comply with the absolute maximum ratings and the instructions included in these specification sheets.
3. These specification sheets include materials protected under copyright of EVERLIGHT corporation. Please don't reproduce or cause anyone to reproduce them without EVERLIGHT's consent.

EVERLIGHT ELECTRONICS CO., LTD.

Office: No 25, Lane 76, Sec 3, Chung Yang Rd,

Tucheno Tainpei 236 Taiwan R O C

Tel: 886-2-2267-2000, 2267-9936

Fax: 886-2267-6244, 2267-6189, 2267-6306

http://www.everlight.com

## X-ON Electronics

Largest Supplier of Electrical and Electronic Components

*Click to view similar products for [Standard LEDs - SMD category](#):*

*Click to view products by [Everlight manufacturer](#):*

Other Similar products are found below :

[LTST-C190KYKT](#) [LTST-C19GD2WT](#) [LTST-N683GBEW](#) [LTW-170ZDC](#) [LTW-M140SZS40](#) [LTW-M140ZVS](#) [598-8110-100F](#) [598-8170-100F](#) [598-8610-202F](#) [AAAF5060QBFSEEZGS](#) [ALMD-LB36-SV002](#) [APT1608QGW](#) [EAST2012YA0](#) [EASV1803BA0](#) [SML-512VWT86A](#) [SML-LX0606SISUGC/A](#) [SML-LXL1307SRC-TR](#) [SML-LXR851SIUPGUBC](#) [LT1ED53A](#) [AM27ZGC03](#) [APB3025SGNC](#) [APFA3010SURKCGKQBDC](#) [APHK1608VGCA](#) [APT2012QGW](#) [CLX6D-FKB-CN1R1H1BB7D3D3](#) [LTST-008BGEW](#) [LTW-010DCG](#) [LTW-020ZDCG](#) [LTW-21TS5](#) [LTW-220DS5](#) [598-8330-117F](#) [SML-LX0402IC-TR](#) [CMDA20AYAA7D1S](#) [CMDA16AYDR7A1X](#) [598-8040-100F](#) [598-8070-100F](#) [598-8140-100F](#) [598-8610-200F](#) [EAST2012GA0](#) [EAPL3527GA5](#) [EAST2012RA0](#) [CMD91-21VRC/TR7](#) [SML-512PWT86A](#) [SMF-2432GYC-TR](#) [EASV3015RGYA0](#) [LTST-C194TBKT-5A](#) [CLX6E-FKC-CH1M1D1BB7C3D3](#) [SML-LXL0805USBC-TR](#) [SML-LX2835SYSUGCTR](#) [CLMUC-FKA-CL81C1L51BB7C3C3](#)