

SMD ■

18-038T/ BDGAR6S1-S06/10T(LT)

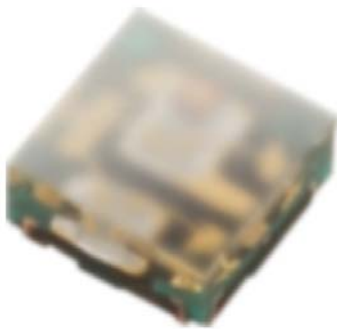

Features

- Package in 8mm tape on 7" diameter reel
- Compatible with automatic placement equipment
- Compatible with infrared and vapor phase reflow
- Solder process
- Full-color type
- Pb-free
- Component solderable surface finish is Gold
- Component weight is 1.0 mg
- RoHS compliant

Description

- The 18-038T SMD LED is much smaller than lead frame type components, thus enable smaller board size, higher packing density, reduced storage space and finally smaller equipment to be obtained.
- Moreover, with its black PCB, the 18-038T possess an ideal solution for high-contrast and high-resolution indoor signage display.

Applications

- Indoor signage display applications
- Indoor decorating and entertainment design
- Flat backlight for LCD, switch and symbol
- Indicator and backlighting for all consumer electronics

Device Selection Guide

| Chip Materials | Emitted Color | Resin Color |
|----------------|-----------------|------------------|
| AlGaInP | Brilliant Red | Surface Diffused |
| InGaN | Brilliant Green | |
| InGaN | Brilliant Blue | |

Absolute Maximum Ratings (Ta=25°C)

| Parameter | Symbol | Rating | Unit |
|-------------------------------------------|--------------------|-----------------------------------------------------------------------------|------|
| Reverse Voltage | V _R | 5 | V |
| Forward Current | I _F | R6:10 GA:10 BD:10 | mA |
| Peak Forward Current (Duty 1/10 @1KHz) | I _{FP} | R6:20 GA:20 BD:20 | mA |
| Power Dissipation | P _d | R6:24 GA:35 BD:35 | mW |
| Junction Temperature | T _j | 100 | °C |
| Operating Temperature | T _{opr} | -40 ~ +85 | °C |
| Storage Temperature | T _{stg} | -40 ~ +90 | °C |
| ESD (Classification acc. AEC Q101) | ESD _{HBM} | R:2000 G:1000 B:1000 | V |
| Soldering Temperature | T _{sol} | Reflow Soldering : 260 °C for 10 sec. Hand Soldering : 350 °C for 3 sec. | |

Electro-Optical Characteristics (Ta=25°C)

| Parameter | Symbol | | Min. | Typ. | Max. | Unit | Condition |
|------------------------------|-------------------|----|-------|-------|-------|------|----------------------|
| Luminous Intensity | Iv | R6 | 37.0 | ----- | 94.0 | mcd | I _F =10mA |
| | | GA | 120.0 | ----- | 300.0 | | |
| | | BD | 20.0 | ----- | 60.0 | | |
| Viewing Angle | 2θ _{1/2} | | ----- | 120 | ----- | deg | I _F =10mA |
| Peak Wavelength | λ _p | R6 | | 632 | | nm | I _F =10mA |
| | | GA | | 518 | | | |
| | | BD | | 468 | | | |
| Dominant Wavelength | λ _d | R6 | 618.0 | | 630.0 | nm | I _F =10mA |
| | | GA | 513.0 | ----- | 531.0 | | |
| | | BD | 461.0 | | 476.0 | | |
| Spectrum Radiation Bandwidth | Δλ | R6 | | 20 | | nm | I _F =10mA |
| | | GA | | 25 | ----- | | |
| | | BD | | 25 | | | |
| Forward Voltage | V _F | R6 | 1.7 | 2.0 | 2.35 | V | I _F =10mA |
| | | GA | 2.5 | 3.3 | 3.7 | | |
| | | BD | 2.5 | 3.3 | 3.7 | | |
| Reverse Current | I _R | | ----- | ----- | 10 | μA | V _R =5V |

Note:

1. Tolerance of Luminous Intensity: ±10%
2. Tolerance of Dominant Wavelength: ±1nm
3. Tolerance of Forward Voltage: ±0.1V

**Floating Bin(R6)
Bin Range of Luminous Intensity**

| Bin Code | Min. | Max. | Unit | Condition |
|----------|------|------|------|---------------------|
| RA | 37 | 45 | mcd | $I_F = 10\text{mA}$ |
| RB | 45 | 54 | | |
| RC | 54 | 65 | | |
| RD | 65 | 78 | | |
| RE | 78 | 94 | | |

Bin Range of Dominant Wavelength

| Bin Code | Min. | Max. | Unit | Condition |
|----------|-------|-------|------|---------------------|
| R1 | 618.0 | 621.0 | nm | $I_F = 10\text{mA}$ |
| R2 | 621.0 | 624.0 | | |
| R3 | 624.0 | 627.0 | | |
| R4 | 627.0 | 630.0 | | |

Bin Range of Dominant Voltage

| Bin Code | Min. | Max. | Unit | Condition |
|----------|------|------|------|---------------------|
| R1 | 1.7 | 2.35 | v | $I_F = 10\text{mA}$ |

Note:

1. Tolerance of Luminous Intensity: $\pm 10\%$
2. Tolerance of Dominant Wavelength: $\pm 1\text{nm}$
3. Tolerance of Forward Voltage: $\pm 0.1\text{V}$

**Floating Bin(GA)
Bin Range of Luminous Intensity**

| Bin Code | Min. | Max. | Unit | Condition |
|----------|------|------|------|---------------------|
| GA | 120 | 144 | mcd | $I_F = 10\text{mA}$ |
| GB | 144 | 173 | | |
| GC | 173 | 208 | | |
| GD | 208 | 250 | | |
| GE | 250 | 300 | | |

Bin Range of Dominant Wavelength

| Bin Code | Min. | Max. | Unit | Condition |
|----------|-------|-------|------|---------------------|
| G1 | 513.0 | 516.0 | nm | $I_F = 10\text{mA}$ |
| G2 | 516.0 | 519.0 | | |
| G3 | 519.0 | 522.0 | | |
| G4 | 522.0 | 525.0 | | |
| G5 | 525.0 | 528.0 | | |
| G6 | 528.0 | 531.0 | | |

Bin Range of Dominant Voltage

| Bin Code | Min. | Max. | Unit | Condition |
|----------|------|------|------|---------------------|
| G1 | 2.5 | 3.7 | v | $I_F = 10\text{mA}$ |

Note:

1. Tolerance of Luminous Intensity: $\pm 10\%$
2. Tolerance of Dominant Wavelength: $\pm 1\text{nm}$
3. Tolerance of Forward Voltage: $\pm 0.1\text{V}$

Floating Bin(BD)
Bin Range of Luminous Intensity

| Bin Code | Min. | Max. | Unit | Condition |
|----------|------|------|------|---------------------|
| BA | 20 | 24 | mcd | $I_F = 10\text{mA}$ |
| BB | 24 | 29 | | |
| BC | 29 | 35 | | |
| BD | 35 | 42 | | |
| BE | 42 | 50 | | |
| BF | 50 | 60 | | |

Bin Range of Dominant Wavelength

| Bin Code | Min. | Max. | Unit | Condition |
|----------|-------|-------|------|---------------------|
| B1 | 461.0 | 464.0 | nm | $I_F = 10\text{mA}$ |
| B2 | 464.0 | 467.0 | | |
| B3 | 467.0 | 470.0 | | |
| B4 | 470.0 | 473.0 | | |
| B5 | 473.0 | 476.0 | | |

Bin Range of Dominant Voltage

| Bin Code | Min. | Max. | Unit | Condition |
|----------|------|------|------|---------------------|
| B1 | 2.5 | 3.7 | v | $I_F = 10\text{mA}$ |

Note:

1. Tolerance of Luminous Intensity: $\pm 10\%$
2. Tolerance of Dominant Wavelength: $\pm 1\text{nm}$
3. Tolerance of Forward Voltage: $\pm 0.1\text{V}$

Typical Electro-Optical Characteristics Curves

Spectrum Distribution

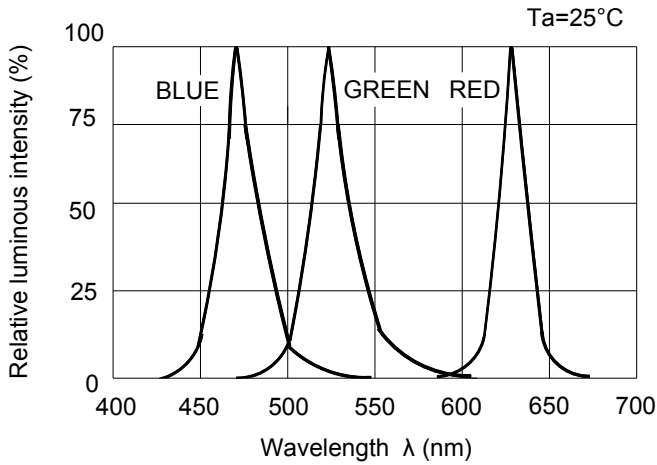

Radiation Diagram $T_a=25^\circ\text{C}$

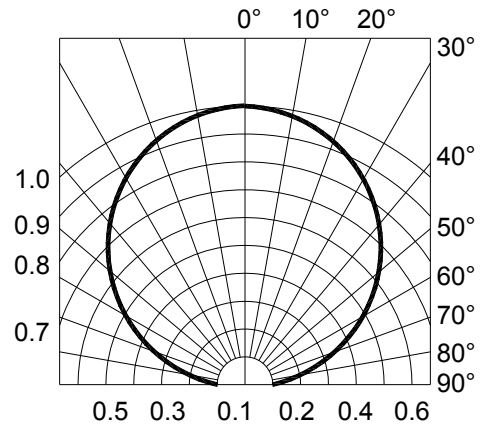

Forward Current vs. Forward Voltage

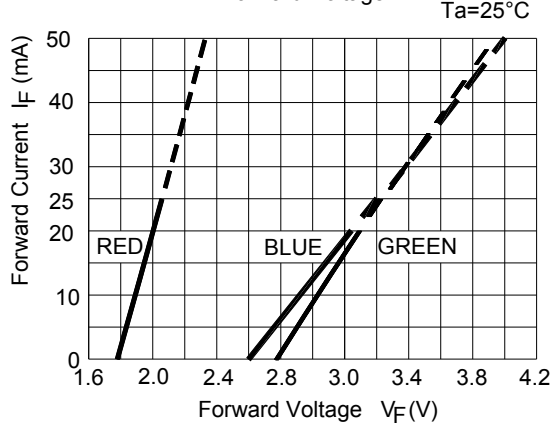

Forward Current Derating Curve

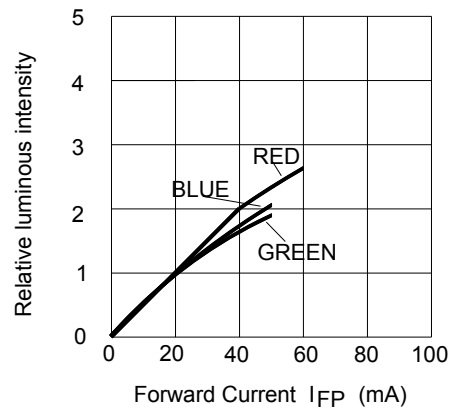

Ambient Temperature vs. Power Dissipation

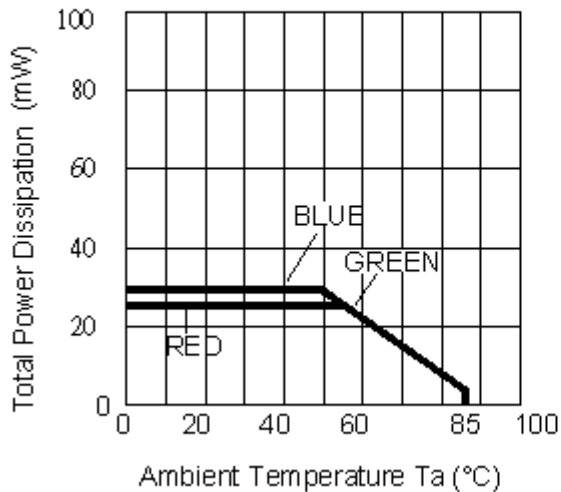

Ambient Temperature vs. Total Power Dissipation

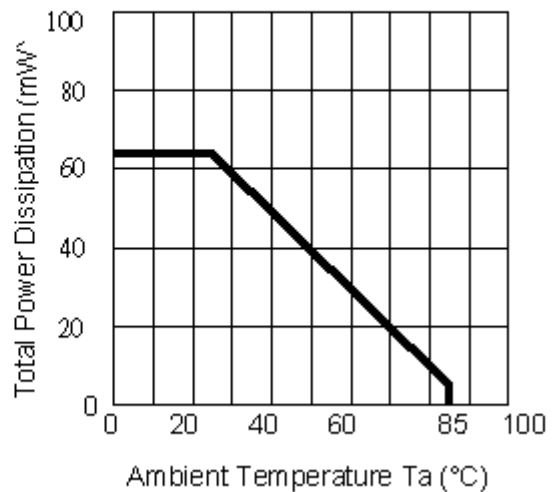

Package Dimension

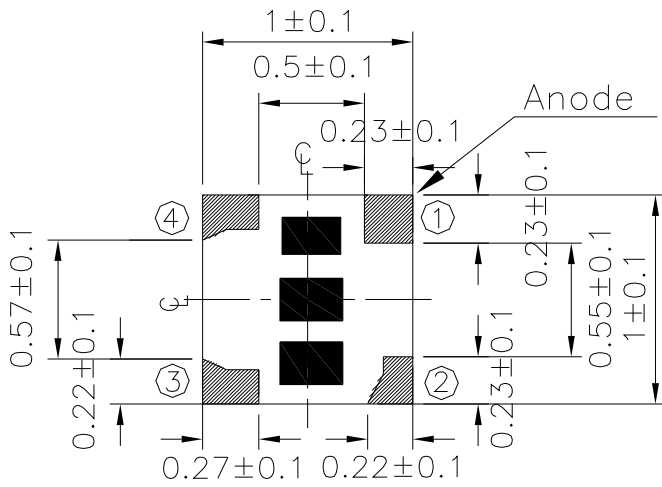

Top

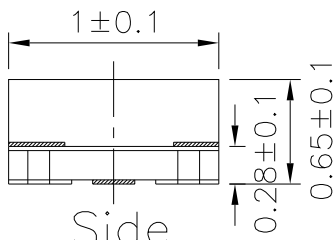

Side

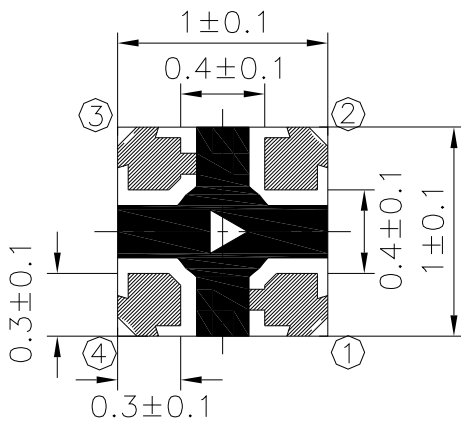

Bottom

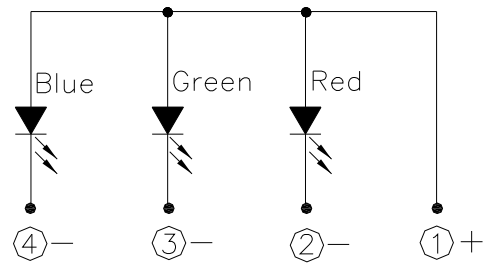

Polarity

Recommend soldering pad

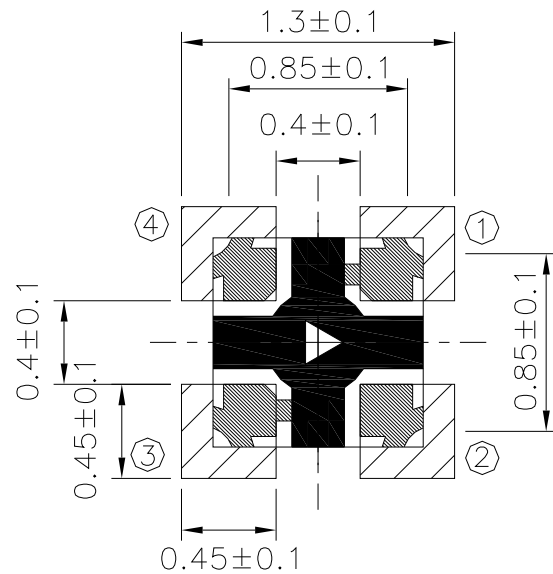

Suggested pad dimension is just for reference only.
Please modify the pad dimension based on individual need.

Note: Tolerances unless mentioned ± 0.1 mm. Unit = mm

Moisture Resistant Packing Materials

Label Explanation

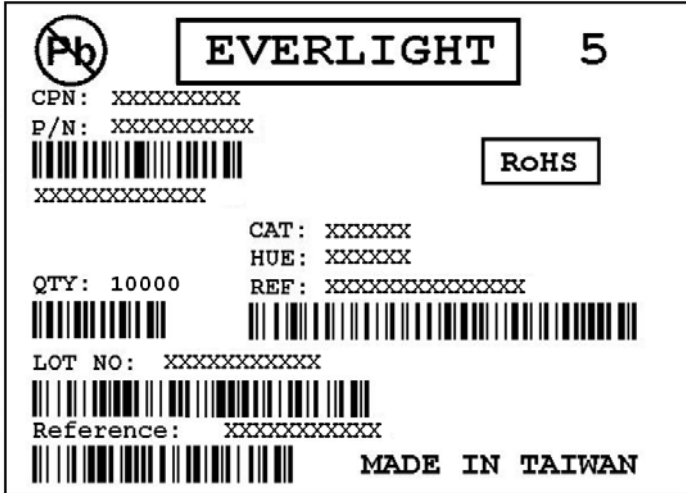

- CPN: Customer's Product Number
- P/N: Product Number
- QTY: Packing Quantity
- CAT: Luminous Intensity Rank
- HUE: Dom. Wavelength Rank
- REF: Forward Voltage Rank
- LOT No: Lot Number

Reel Dimensions

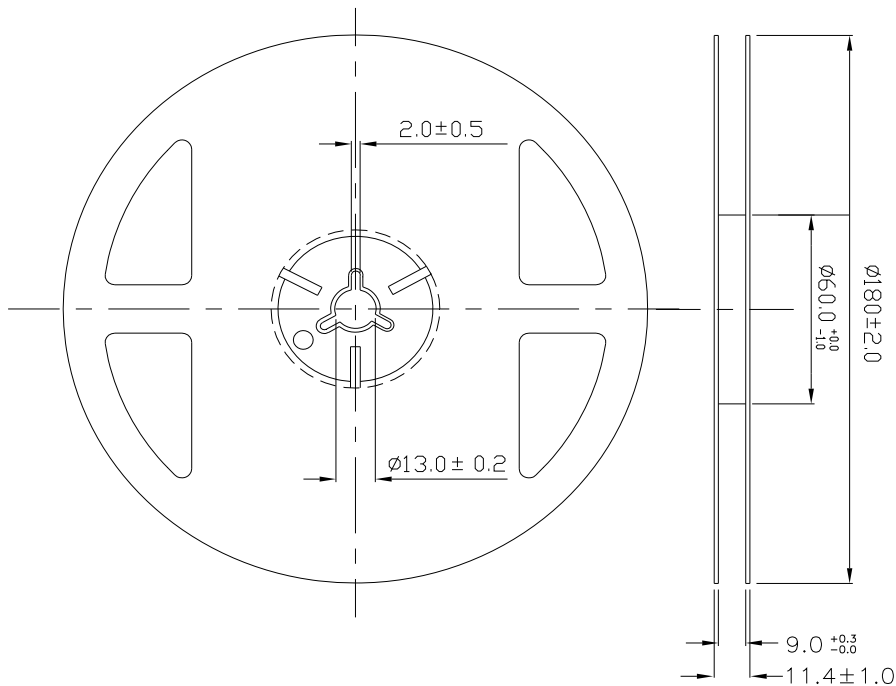

Carrier Tape Dimensions:

The minimum quantity of packing is 10000 pcs per reel. The rest quantity which could not reach 10000 pcs per reel will go to 4000 pcs per reel.

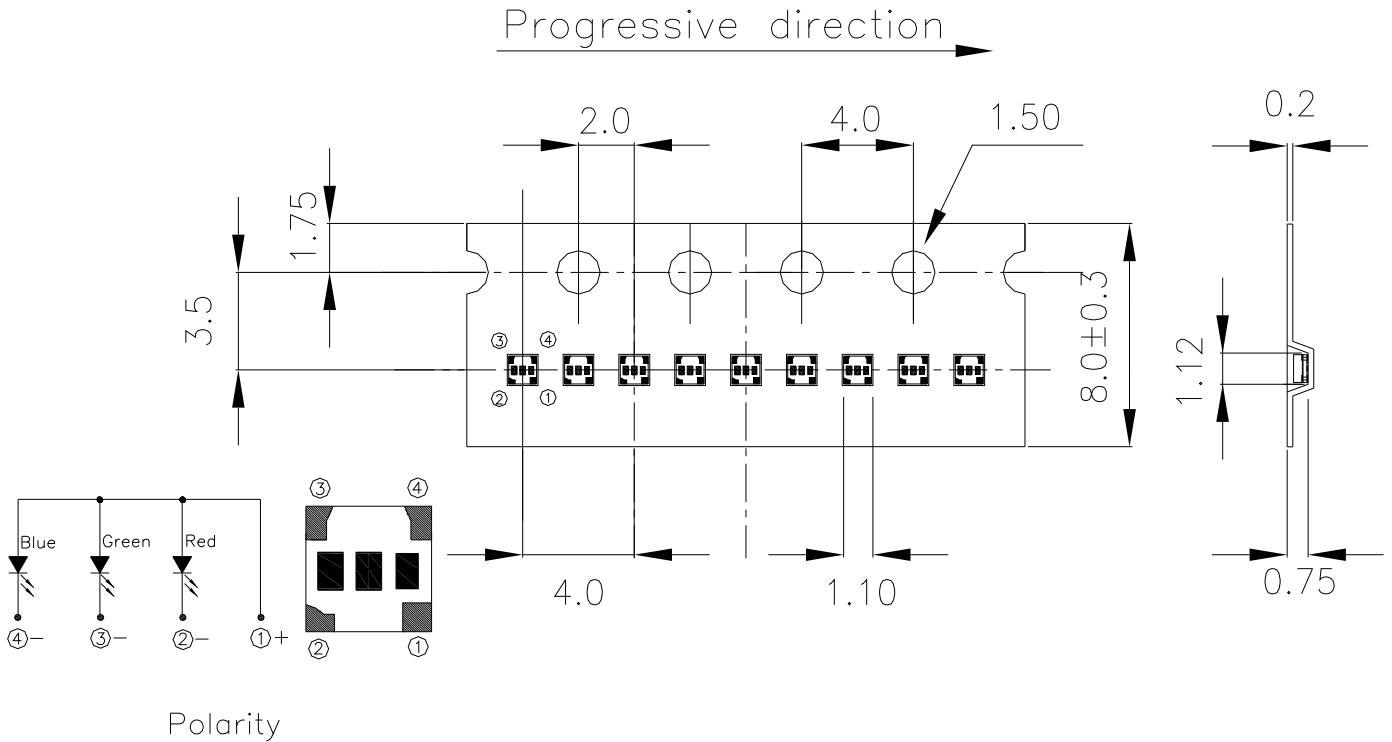

Note: Tolerances unless mentioned ± 0.1 mm. Unit = mm

Moisture Resistant Packing Process

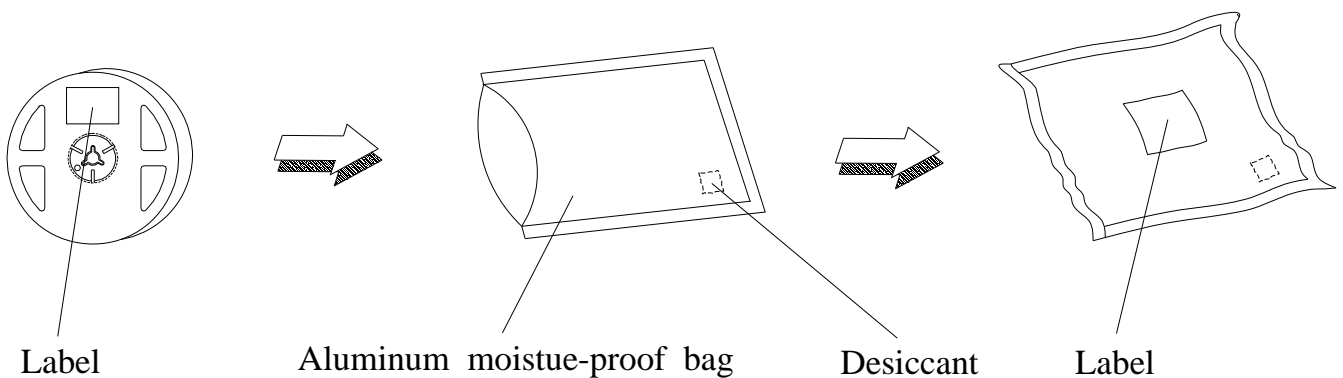

Note: Tolerances unless mentioned ± 0.1 mm. Unit = mm

Precautions for Use

1. Over-current-proof

Customer must apply resistors for protection, otherwise slight voltage shift will cause big current change (Burn out will happen).

2. Storage

2.1 Do not open moisture proof bag before the products are ready to use.

2.2 Before opening the package: The LEDs should be kept at 30°C or less and 90%RH or less.

2.3 After opening the package: The LED's floor life is 168Hrs under 30°C or less and 60% RH or less. If unused LEDs remain, it should be stored in moisture proof packages.

2.4 If the moisture absorbent material (silica gel) has faded away or the LEDs have exceeded the storage time, baking treatment should be performed using the following conditions.

Baking treatment : 60±5°C for 24 hours.

2.5 Before using LEDs, baking treatment should be implemented based on the following conditions: pre-curing at 60±5°C for 24 hours or 125±5°C for 3 hours.

3. Soldering Condition

3.1 Pb-free solder temperature profile

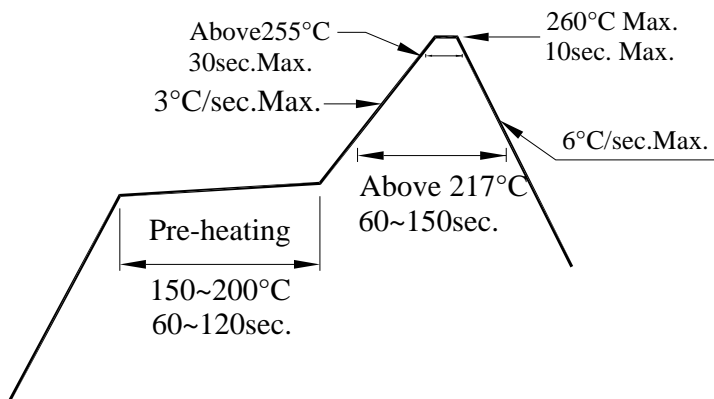

3.2 Reflow soldering should not be done more than two times.

3.3 When soldering, do not put stress on the LEDs during heating.

3.4 After soldering, do not warp the circuit board.

4. Soldering Iron

Each terminal is to go to the tip of soldering iron temperature less than 350°C for 3 seconds within once in less than the soldering iron capacity 25W. Leave two seconds and more intervals, and do soldering of each terminal. Be careful because the damage of the product is often started at the time of the hand solder.

5.Repairing

Repair should not be done after the LEDs have been soldered. When repairing is unavoidable, a double-head soldering iron should be used (as below figure). It should be confirmed beforehand whether the characteristics of the LEDs will or will not be damaged by repairing.

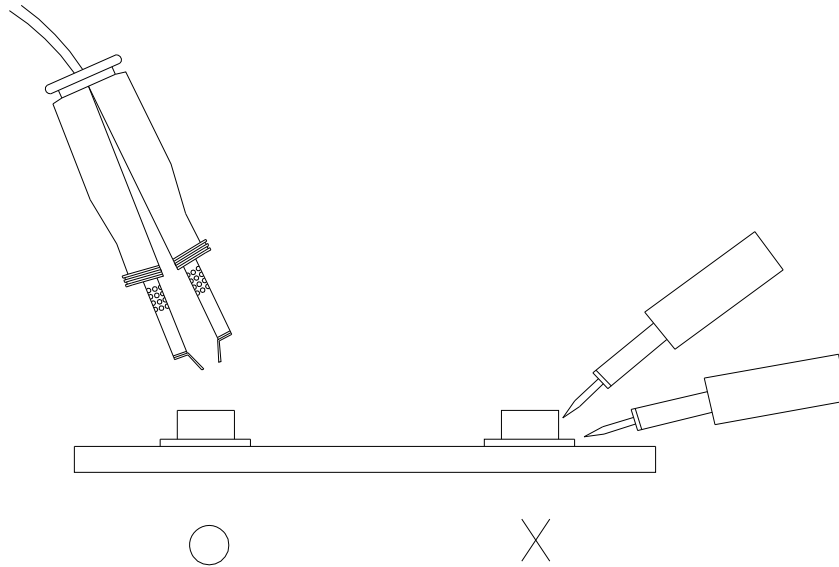

6.Directions for use

The LEDs should be operated with forward bias. The driving circuit must be designed so that the LEDs are not subjected to forward or reverse voltage while it is off. If reverse voltage is continuously applied to the LEDs, It may cause migration resulting in LED damage.

EVERLIGHT ELECTRONICS CO., LTD.
Office: No 6-8, Zhonghua Rd., Shulin Dist.,
New Taipei City 23860, Taiwan, R.O.C

Tel: 886-2-2685-6688
Fax: 886-2-2685-6699
<http://www.everlight.com>

X-ON Electronics

Largest Supplier of Electrical and Electronic Components

Click to view similar products for [Standard LEDs - SMD category](#):

Click to view products by [Everlight manufacturer](#):

Other Similar products are found below :

[LTST-C190KYKT](#) [LTST-C19GD2WT](#) [LTST-N683GBEW](#) [LTW-170ZDC](#) [LTW-M140SZS40](#) [LTW-M140ZVS](#) [598-8110-100F](#) [598-8170-100F](#) [598-8610-202F](#) [AAAF5060QBFSEEZGS](#) [ALMD-LB36-SV002](#) [APT1608QGW](#) [EAST2012YA0](#) [EASV1803BA0](#) [SML-512VWT86A](#) [SML-LX0606SISUGC/A](#) [SML-LXL1307SRC-TR](#) [SML-LXR851SIUPGUBC](#) [LT1ED53A](#) [AM27ZGC03](#) [APB3025SGNC](#) [APFA3010SURKCGKQBDC](#) [APHK1608VGCA](#) [APT2012QGW](#) [CLX6D-FKB-CN1R1H1BB7D3D3](#) [LTST-008BGEW](#) [LTW-020ZDCG](#) [LTW-21TS5](#) [LTW-220DS5](#) [598-8330-117F](#) [SML-LX0402IC-TR](#) [CMDA20AYAA7D1S](#) [CMDA16AYDR7A1X](#) [91-21SYGD/S530-E2/TR7](#) [598-8040-100F](#) [598-8070-100F](#) [598-8140-100F](#) [598-8610-200F](#) [EAST2012GA0](#) [EAPL3527GA5](#) [SML-LXL1209SYC/ATR](#) [EAST2012RA0](#) [CMD91-21VRC/TR7](#) [SML-LXR851SGSIC-TR](#) [SML-512PWT86A](#) [SMF-2432GYC-TR](#) [LTST-C194TBKT-5A](#) [CLX6E-FKC-CH1M1D1BB7C3D3](#) [SML-LXL0805USBC-TR](#) [SML-LX2835SYSUGCTR](#)