

Hyper Mini Top View LEDs 45-11-BNSB-39404501E-2T8-AM



Features

- RoHS compliant.
- P-LCC-2 package.
- Wide viewing angle 120°.
- Inner reflector and white package.
- Qualification according to AEC-Q101.
- Precondition: Based on JEDEC J-STD 020 Level 3.
- Useable in severe lead free processes with automotive reflow profile (IR reflow or wave soldering)

Applications

- Automotive backlighting or indicator: Dashboard, switch, audio and video equipments...etc.
- Backlight: LCD, switches, symbol, mobile phone and illuminated advertising.
- Display for indoor and outdoor application.
- Ideal for coupling into light guides.
- Substitution of traditional light.
- Optical indicator.
- General applications.

Device Selection Guide

Chip Materials	Emitted Color	Resin Color
InGaN	White	Yellowish

Coding:

45-11-BXXB-XXXXXXXXXX-2T8-AM

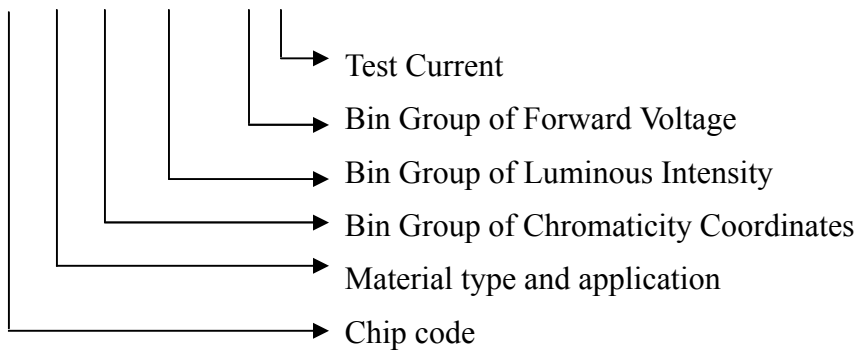

EVERLIGHT

Absolute Maximum Ratings (Ta=25)

Parameter	Symbol	Rating	Unit
Forward Current	I_F	30	mA
Peak Forward Current (Duty 1/10 @1KHz)	I_{FP}	100	mA
Power Dissipation	P_d	110	mW
Junction Temperature	T_j	125	
Operating Temperature	T_{opr}	-40 ~ +100	
Storage Temperature	T_{stg}	-40 ~ +110	
Thermal Resistance	$R_{th\ J-A}$	500	K/W
	$R_{th\ J-S}$	300	K/W
ESD (Classification acc. AEC Q101)	ESD_{HBM}	2000	V
	ESD_{MM}	200	V
Soldering Temperature	T_{sol}	Reflow Soldering : 260 Hand Soldering : 350	for 30 sec. for 3 sec.

Electro-Optical Characteristics (Ta=25)

Parameter	Symbol	Min.	Typ.	Max.	Unit	Condition
Viewing Angle	2 1/2	---	120	---	deg	I _F =20mA
Reverse Current	I _R	---	---	50	μA	V _R =5V
Temperature coefficient of λ _p	TC _{λ_p}	---	0.03	---	nm/K	I _F =20mA
Temperature coefficient of λ _d	TC _{λ_d}	---	0.02	---	nm/K	I _F =20mA
Temperature coefficient of V _F	TC _V	---	-2.8	---	mV/K	I _F =20mA

EVERLIGHT

Bin Code of Chromaticity Coordinates

Bin Code	CIE_x	CIE_y	Bin Code	CIE_x	CIE_y
A0+1	0.2569	0.2528	A0+2	0.2640	0.2670
	0.2498	0.2385		0.2569	0.2528
	0.2584	0.2283		0.2652	0.2429
	0.2652	0.2429		0.2720	0.2575
A0+3	0.2652	0.2429	A0+4	0.2720	0.2575
	0.2584	0.2283		0.2652	0.2429
	0.2666	0.2185		0.2733	0.2333
	0.2733	0.2333		0.2800	0.2480
A0-1	0.2720	0.2575	A0-2	0.2818	0.2715
	0.2640	0.2670		0.2755	0.2810
	0.2755	0.2810		0.2870	0.2950
	0.2818	0.2715		0.2915	0.2855
A0-3	0.2800	0.2480	A0-4	0.2879	0.2619
	0.2720	0.2575		0.2818	0.2715
	0.2818	0.2715		0.2915	0.2855
	0.2879	0.2619		0.2960	0.2760

Note:
Tolerance of Chromaticity Coordinates: ± 0.01

Bin Code of Chromaticity Coordinates

Bin Code	CIE_x	CIE_y	Bin Code	CIE_x	CIE_y
B5-1	0.2915	0.2855	B5-2	0.3003	0.2950
	0.2870	0.2950		0.2970	0.3050
	0.2970	0.3050		0.3070	0.3150
	0.3003	0.2950		0.3090	0.3045
B5-3	0.2960	0.2760	B5-4	0.3035	0.2850
	0.2915	0.2855		0.3003	0.2950
	0.3003	0.2950		0.3090	0.3045
	0.3035	0.2850		0.3110	0.2940
B6-1	0.3090	0.3045	B6-2	0.3195	0.3165
	0.3070	0.3150		0.3185	0.3270
	0.3185	0.3270		0.3300	0.3390
	0.3195	0.3165		0.3300	0.3285
B6-3	0.3110	0.2940	B6-4	0.3205	0.3060
	0.3090	0.3045		0.3195	0.3165
	0.3195	0.3165		0.3300	0.3285
	0.3205	0.3060		0.3300	0.3180

Note:
Tolerance of Chromaticity Coordinates: ± 0.01

The C.I.E. 1931 Chromaticity Diagram

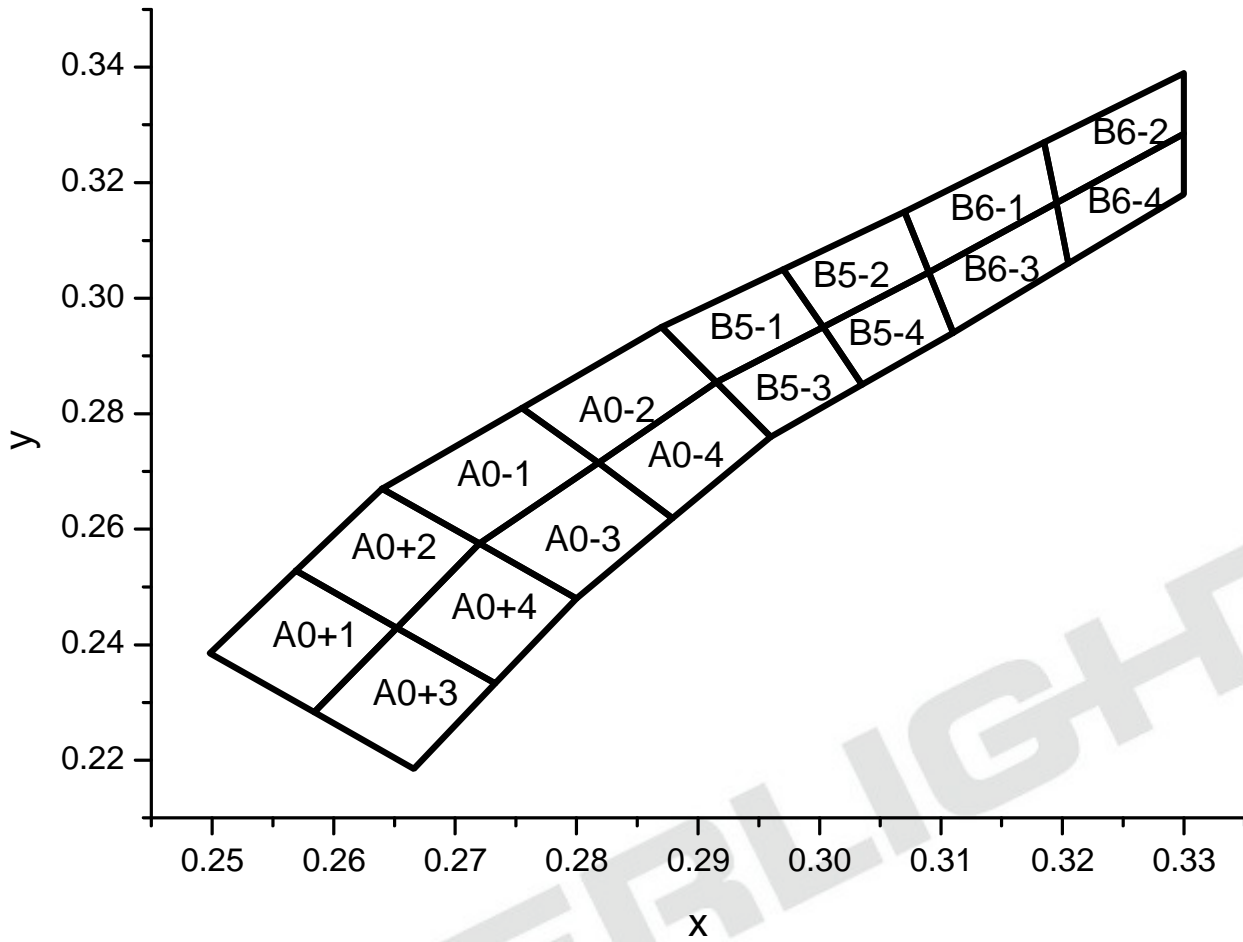

Bin Range of Chromaticity Coordinates Block

Group	Range	Group	Range
01	B5-1,B5-2,B5-3,B5-4	27	A0-2, A0-1, A0-3
02	B5-1~B5-4,A0-2,A0-4	28	A0-2, A0-4, A0-3
07	B5-1,B5-3,A0-4	29	A0-2, B5-1, B5-3
08	A0-2,A0-3,A0-4	30	A0-2, A0-4, B5-3
09	A0-1,A0-3,A0+4	31	B5-1, A0-2, A0-4
10	A0+1, A0+2, A0-1	32	B5-1, B5-3, A0-4
11	A0+2, A0-1, A0-2	33	B5-1, B5-2, B5-4
12	A0-1, A0-2, B5-1	34	B5-1, B5-3, B5-4
13	A0-2, B5-1, B5-2	35	B5-2, B5-1, B5-3
14	A0+3, A0+4, A0-3	36	B5-2, B5-4, B5-3
15	A0+4, A0-3, A0-4	37	B5-1, B5-2
16	A0-3, A0-4, B5-3	38	A0-1, A0-3
17	A0-4, B5-3, B5-4	39	A0-2,A0-4,B5-1,B5-3
18	A0+1, A0+2, A0+4	40	A0-3,A0-4
19	A0+1, A0+3, A0+4	41	A0-4,B5-1,B5-3,B5-4
20	A0+2, A0+1, A0+3	42	A0-4, B5-3
21	A0+2, A0-1, A0-3	43	B5-2,B5-4
22	A0+2, A0+4, A0-3	44	A0-1,A0-2,A-4,B5-3
23	A0-1, A0+2, A0+4	45	B5-1, B5-3
24	A0-1, A0-3, A0+4	46	A0+1, A0+2
25	A0-1, A0-2, A0-4	47	B6-1, B6-2, B6-3, B6-4
26	A0-1, A0-3, A0-4	48	B6-2,B6-4

Group	Range	Group	Range
49	B5-3, B5-4		
50	A0-1, A0-2, A0-3, A0-4		
51	A0+1, A0+2, A0+3, A0+4		
52	A0+3, A0+4		
53	B6-1, B6-2, B6-3		
54	B6-1, B6-3		
55	B5-2, B5-4, B6-1, B6-3		
56	B5-2, B6-1		
57	A0-2, B5-1		
58	A0-1, A0-2		
59	A0-1, A0-2, A0-3, A0-4, B5-1		
60	A0+2, A0+4, A0-1, A0-3		
61	A0+4, A-3, A0-4		
62	A0-2, B5-1, B5-3, B5-4		
63	A0-1~A0-4, B5-1, B5-3		
64	A0-2, A0-4		
65	A0-1~A0-4, B5-1~B5-4		
66	A0-1, A0-3, A0-4, A0+2		
67	A0-1~A0-4, B5-1~B5-4, B6-1, B6-3		

Bin Range of Luminous Intensity

Bin Code	Min.	Max.	Unit	Condition
24	1300	1350	mcd	I _F =20mA
25	1350	1400		
26	1400	1450		
27	1450	1500		
28	1500	1550		
29	1550	1600		
30	1600	1650		
31	1650	1700		
32	1700	1750		
33	1750	1800		
34	1800	1850		
35	1850	1900		
36	1900	1950		
37	1950	2000		
38	2000	2050		
39	2050	2100		
40	2100	2150		
41	2150	2200		
42	2200	2250		
43	2250	2300		
44	2300	2350		
45	2350	2400		

Note:
Tolerance of Luminous Intensity: ±11%

Bin Range of Forward Voltage

Group	Bin Code	Min.	Max.	Unit	Condition
01	5-1	2.75	2.85	V	I _F =20mA
	5-2	2.85	2.95		
	6-1	2.95	3.05		
	6-2	3.05	3.15		
	7-1	3.15	3.25		
	7-2	3.25	3.35		

Group	Bin Code	Min.	Max.	Unit	Condition
02	6-11	3.00	3.05	V	I _F =20mA
	6-2	3.05	3.15		
	7-1	3.15	3.25		
	7-2	3.25	3.35		
	8-1	3.35	3.45		

Group	Bin Code	Min.	Max.	Unit	Condition
03	6-1-3	3.00	3.10	V	I _F =20mA
	6-2-3	3.10	3.20		
	7-1-3	3.20	3.30		
	7-2-3	3.30	3.40		
	8-1-3	3.40	3.50		

Note:
Tolerance of Forward Voltage: ±0.05V

Typical Electro-Optical Characteristics Curves

Typical Curve of Spectral Distribution

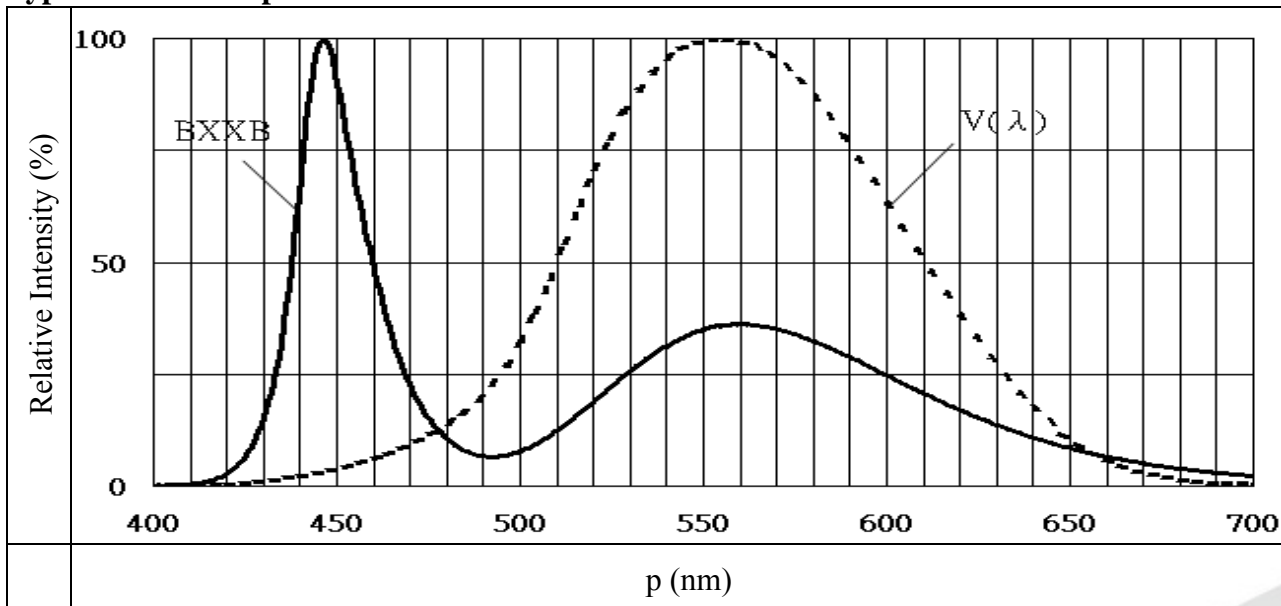

Note: $V(\lambda)$ =Standard eye response curve; $I_F = 20\text{mA}$

Diagram Characteristics of Radiation

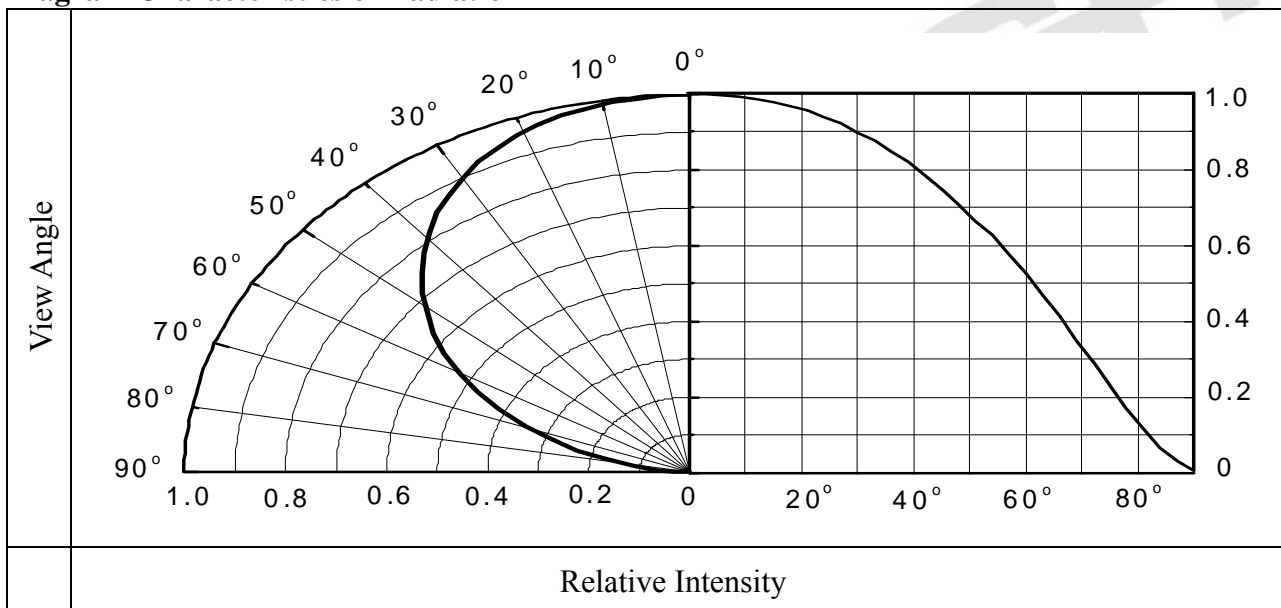

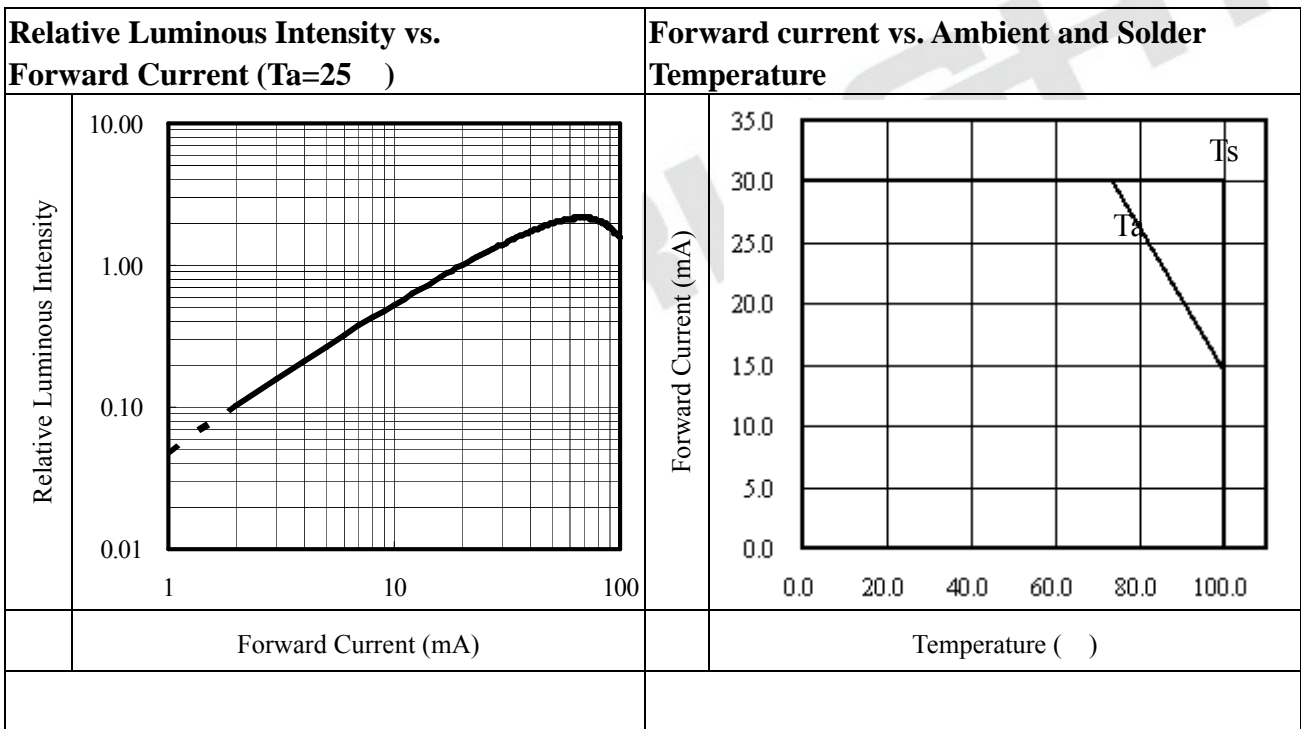
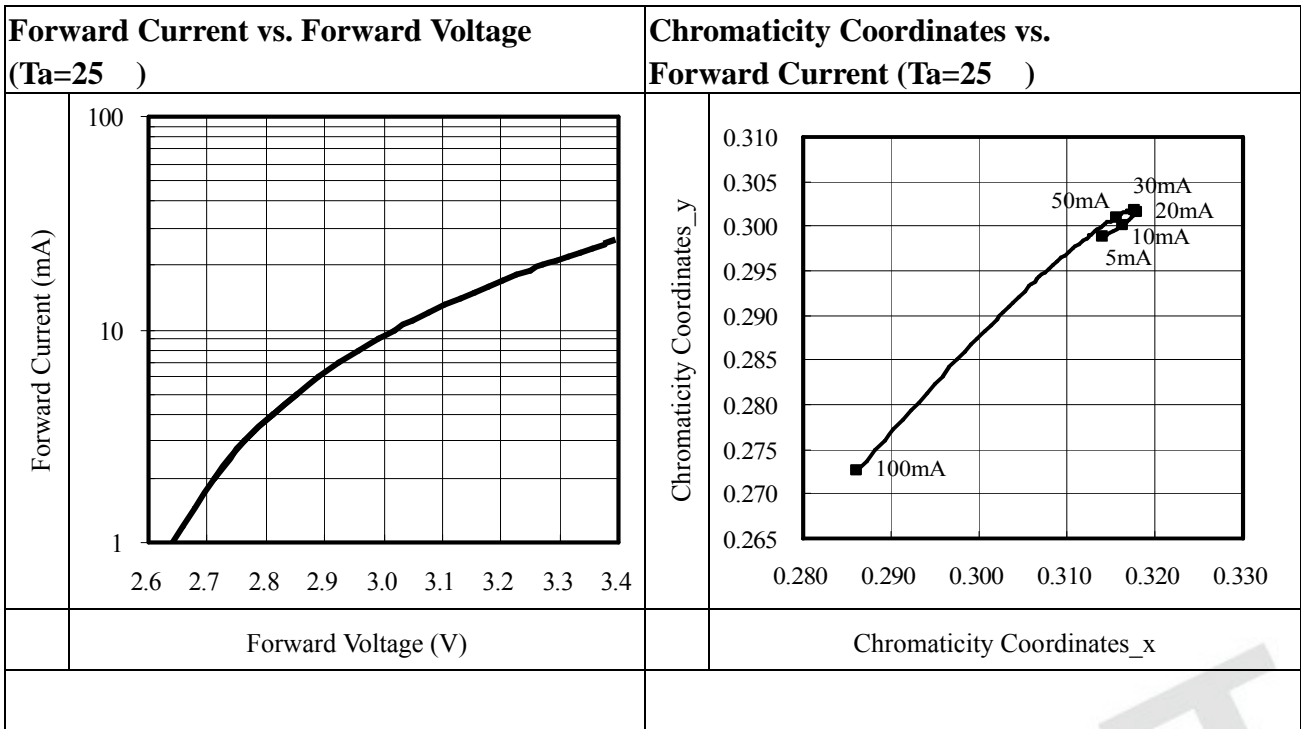

Relative Luminous Intensity vs. Junction Temperature		Relative Forward Voltage vs. Junction Temperature	
Relative Luminous Intensity		Relative Forward Voltage	
	Junction Temperature ()		Junction Temperature ()
Note: $f(T_j) = I_v / I_v(25)$; $I_F = 20\text{mA}$		Note: $V_F = V_F - V_F(25) = f(T_j)$; $I_F = 20\text{mA}$	

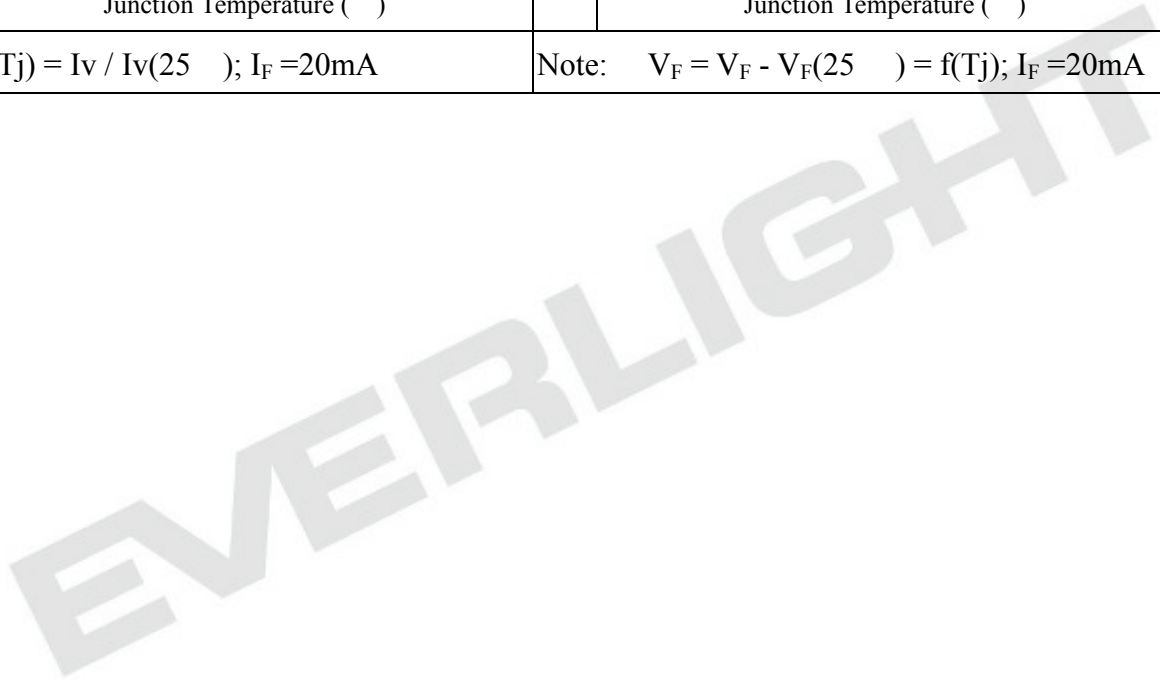

Package Outline Dimensions

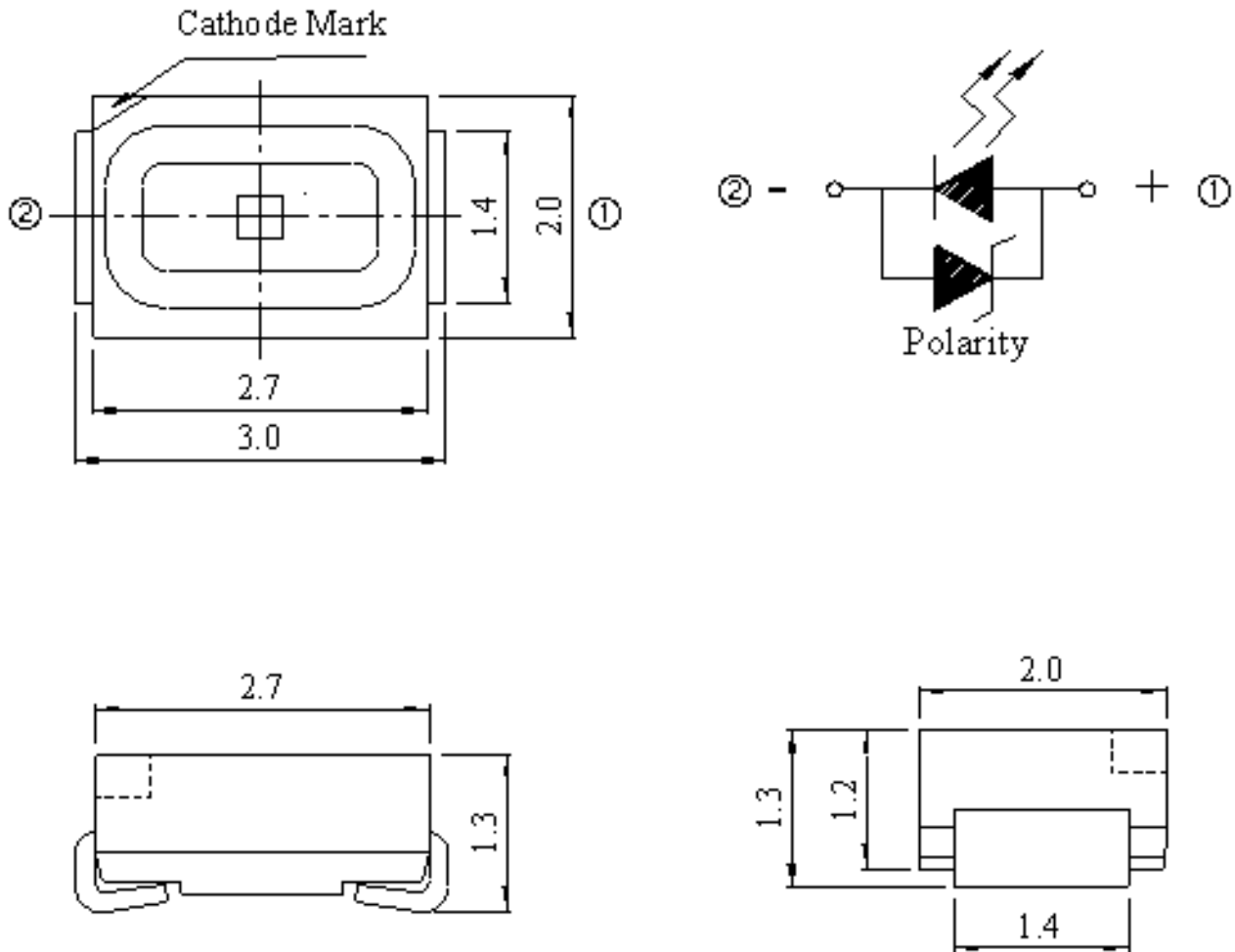

Note: Tolerances unless mentioned ± 0.1 mm. Unit = mm

Moisture Resistant Packing Materials

Label Explanation

- CPN: Customer's Product Number
- P/N: Product Number
- QTY: Packing Quantity
- CAT: Luminous Intensity Rank
- HUE: Dom. Wavelength Rank
- REF: Forward Voltage Rank
- LOT No: Lot Number

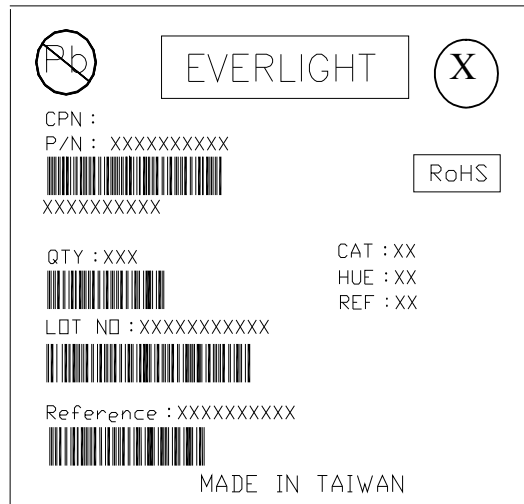

Reel Dimensions

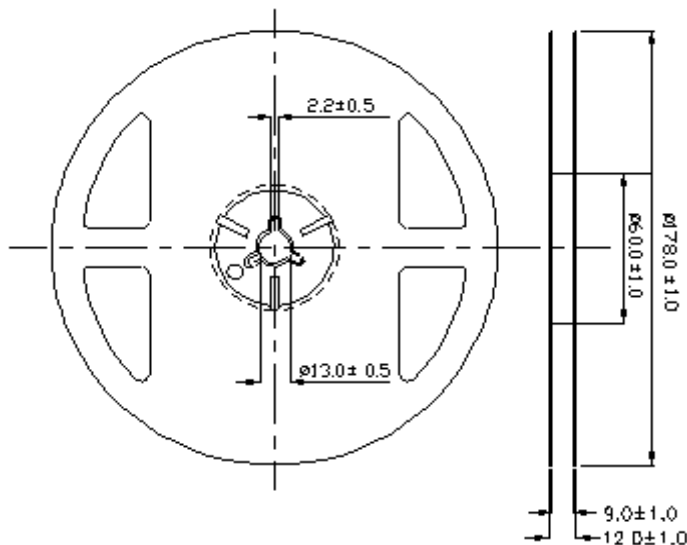

Note: Unit = mm

Carrier Tape Dimensions: Loaded Quantity 2000 pcs Per Reel

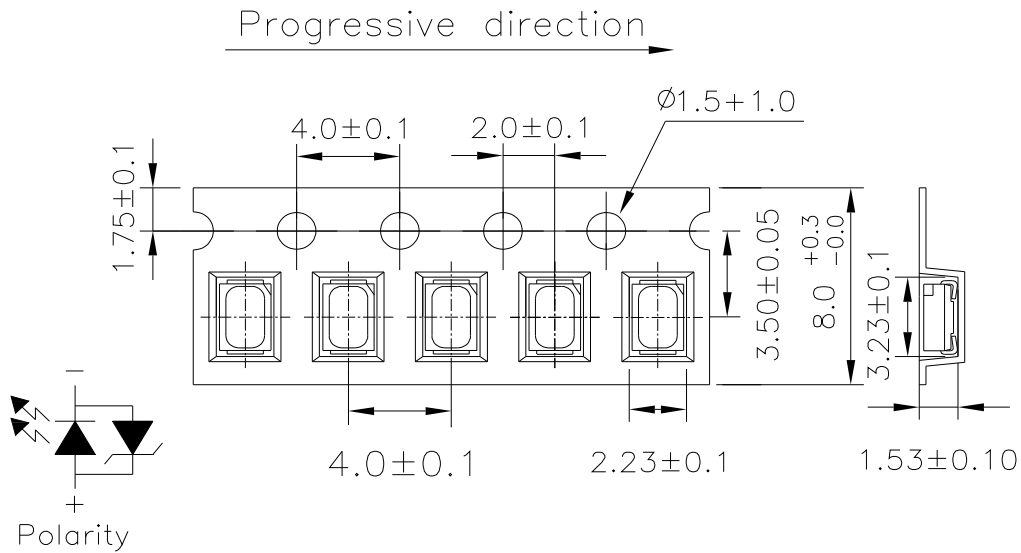

Note: Tolerances unless mentioned ± 0.1 mm. Unit = mm

Moisture Resistant Packing Process

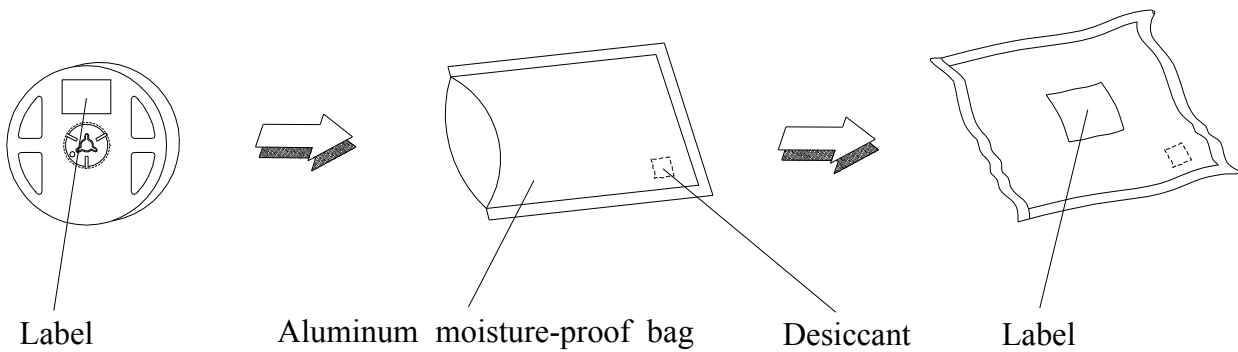

Precautions for Use

1. Soldering Condition

1.1 (A) Maximum Body Case Temperature Profile for evaluation of Reflow Profile

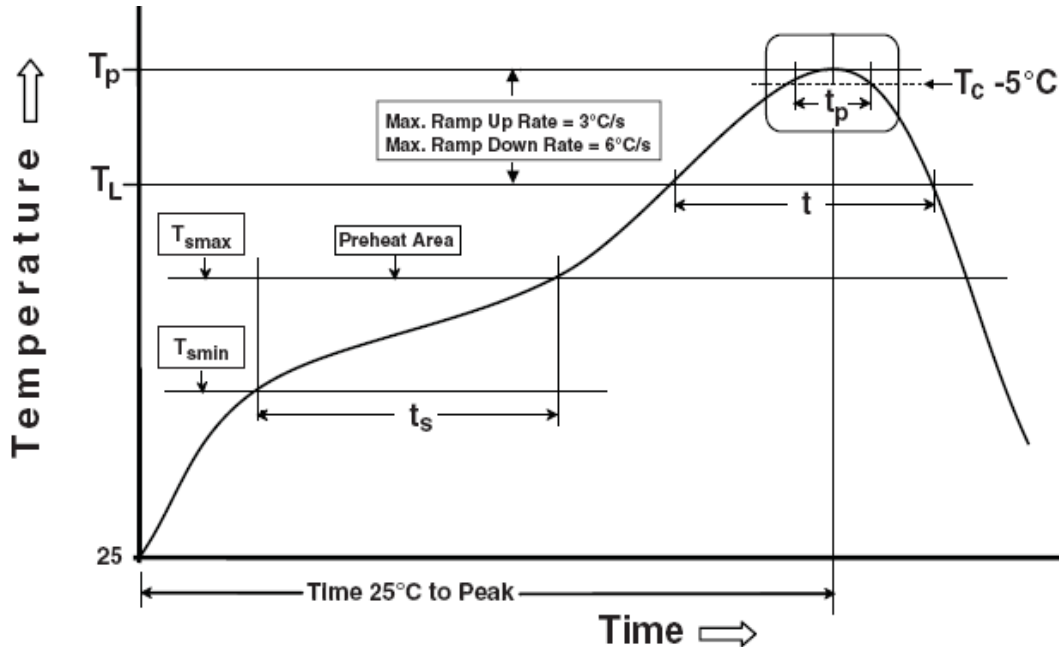

Note:

Reference: IPC/JEDEC J-STD-020D

Preheat

Temperature min (T_{smin})	150 °C
Temperature max (T_{smax})	200°C
Time (T_{smin} to T_{smax}) (t_s)	60-120 seconds
Average ramp-up rate (T_{smax} to T_p)	3 °C/second max

Other

Liquidus Temperature (T_L)	217 °C
Time above Liquidus Temperature (t_L)	60-150 sec
Peak Temperature (T_p)	260°C
Time within 5 °C of Actual Peak Temperature: $T_p - 5^\circ\text{C}$	30 s
Ramp- Down Rate from Peak Temperature	6°C /second max.
Time 25°C to peak temperature	8 minutes max.
Reflow times	3 times

All parameters are maximum body case temperature values and cannot be considered as a soldering profile. The body case temperature was measured by soldering a thermal couple to the soldering point of LEDs.

(B) Recommend soldering pad

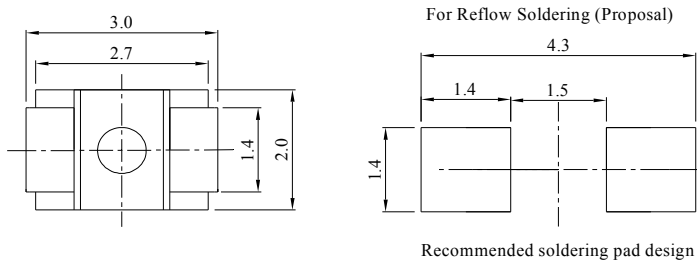

Note: Tolerances unless mentioned ± 0.1 mm. Unit = mm

2. Current limiting

A resistor should be used to limit current spikes that can be caused by voltage fluctuations. Otherwise damage could occur.

3. Storage

- 3.1 Moisture proof bag should only be opened immediately prior to usage.
- 3.2 Environment should be less than 30 °C and 60% RH when moisture proof bag is opened.
- 3.3 After opening the package MSL Conditions stated on page 1 of this spec should not be exceeded.
- 3.4 If the moisture sensitivity card indicates higher than acceptable moisture, the component should be baked at min. 60deg +/-5deg for 24 hours.

4. Iron Soldering

Hand soldering is not recommended for regular production. These guidelines are for rework only. Soldering iron tip should contact each terminal no more than 3 sec at 350 °C, using soldering iron with nominal power less than 25W. Allow min. 2 sec. between soldering intervals.

5. Usage

Do not exceed the values given in this specification.

Application Restrictions

High reliability applications such as military/aerospace, automotive safety/security systems, and medical equipment may require different product. If you have any concerns, please contact Everlight before using this product in your application. This specification guarantees the quality and performance of the product as an individual component. Do not use this product beyond the specification described in this document.

X-ON Electronics

Largest Supplier of Electrical and Electronic Components

Click to view similar products for [everlight manufacturer](#):

Other Similar products are found below :

[11-21/R8C-AP1Q2B/2T](#) [HLMP4719](#) [ELSH-F71G1-0LPNM-CG2G3](#) [MAN6760](#) [EL3063S1\(TA\)](#) [EL452\(TA\)-VG](#) [EL-17-21SURC/S530-A2/TR8](#) [4N35S\(TA\)](#) [A694B/2SUR/S530-A3](#) [22-23C/R6GHBHW-C01/2C](#) [MV64521](#) [11-21SURC-S530-A3-TR8](#) [12-22SDRSYGC/S530-A3/E3/TR8](#) [IR383C](#) [MV53123](#) [HLMP2785](#) [ELSH-Q61F1-0LPNM-JF3F8](#) [MAN6940](#) [ELSW-J11C1-0CPGS-C5700](#) [MV5464MP4B](#) [204-10SUGC/S400-A4-L](#) [12-21/BHC-AP1Q2M/2C](#) [ELSH-F81M1-0CPGS-C3000](#) [PD15-21C/TR8](#) [45-21SCUM2C/L1720NE6/TR8-T](#) [EADCT056RA1](#) [61-238/LK2C-B50638F6GB2/ET](#) [HLMP-2550](#) [IR67-21C/L261/S65/TR8](#) [4N25M](#) [19-213SYGC/S530-E2/TR8](#) [IR333C-F-A](#) [264-7ID](#) [45-11-BFSB-49373902E-2T8-AM](#) [MSQC4411C](#) [PD95-21B/TR10](#) [IRM-H920J5/TR2](#) [EL814](#) [1254-10SURT/S530-A3](#) [ITR9702-F](#) [67-21/T2C-ZV1W2E/2T](#) [EL827](#) [MV8411](#) [67-31EP6-UYD8395DAFAZ5-ET0D-AM](#) [EL3083](#) [45-21UYC/S530-A3/TR8](#) [IR908-7C\(E4\)](#) [ITR9707](#) [ELSH-F41R1-0LPNM-AR5R6](#) [99-616LM2C/L7580S76/TR8-T/ES](#)