

SMD ■ MID Power LED

67-23ST/KKE-NXXXXX96Z10/SZM/2T

**Features**

- PLCC-2 package
- Top view white LED
- High luminous intensity output
- Wide viewing angle
- Pb-free
- ANSI Binning
- The product itself will remain within RoHS compliant version.
- Compliance with EU REACH.
- Compliance Halogen Free .(Br<900ppm,Cl<900ppm,Br+Cl<1500ppm)

Description

The Everlight 67-23ST package has high efficacy, high CRI, low power consumption, wide viewing angle and a compact form factor. These features make this package an ideal LED for all lighting applications.

Applications

- General lighting
- Decorative and Entertainment Lighting
- Indicators
- Illumination
- Switch lights

Product Number Explanation

67-23ST/ K KE - N XX XX XX Z10 / 2 T

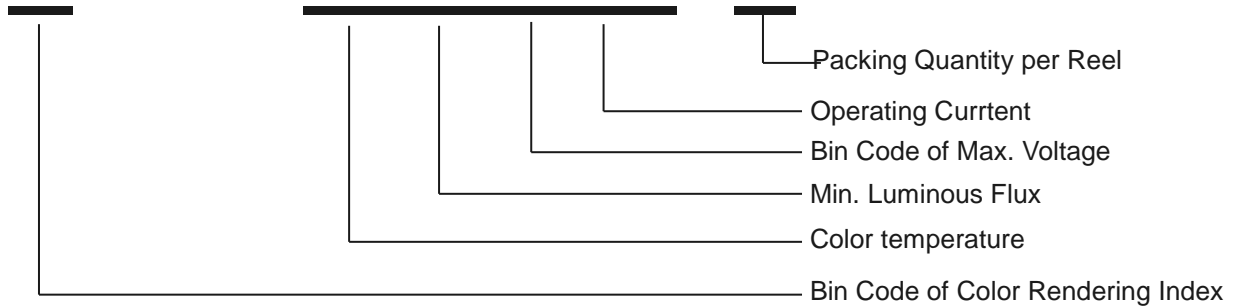

Table of Color Rendering Index

Symbol	Description
M	CRI(Min.) : 60
N	CRI(Min.) : 65
L	CRI(Min.) : 70
Q	CRI(Min.) : 75
K	CRI(Min.) : 80
P	CRI(Min.) : 85
H	CRI(Min.) : 90
R	CRI(Min.) : 90 R9>50

Note:
 Tolerance of Color Rendering Index: ±2

Table of Forward Current Index

Symbol	Description
Z10	I _F :100mA

Table of Forward Voltage Index

Symbol	Description
96	9.6V max

Example:
 67-23ST/KKE-N2712096Z10/SZM/2T

CRI	80(Min.)
CCT	2700K
Flux	120lm min
V _F	9.6V max
I _F	100mA

Mass Production List

Series For 2700K 110Lm

Product	CRI Min. ⁽¹⁾	CCT(K)	Φ(lm) Min. ⁽²⁾
67-23ST/KKE-N2210596Z10/SZM/2T	80	2200K	105
67-23ST/KKE-N2711096Z10/SZM/2T	80	2700K	110
67-23ST/KKE-N3011796Z10/SZM/2T	80	3000K	117
67-23ST/KKE-N4012396Z10/SZM/2T	80	4000K	123
67-23ST/KKE-N5012396Z10/SZM/2T	80	5000K	123
67-23ST/KKE-N5712396Z10/SZM/2T	80	5700K	123
67-23ST/KKE-N6512396Z10/SZM/2T	80	6500K	123

Series For 2700K 115Lm

Product	CRI Min. ⁽¹⁾	CCT(K)	Φ(lm) Min. ⁽²⁾
67-23ST/KKE-N2711596Z10/SZM/2T	80	2700K	115
67-23ST/KKE-N3012296Z10/SZM/2T	80	3000K	122
67-23ST/KKE-N4012896Z10/SZM/2T	80	4000K	128
67-23ST/KKE-N5012896Z10/SZM/2T	80	5000K	128
67-23ST/KKE-N5712896Z10/SZM/2T	80	5700K	128
67-23ST/KKE-N6512896Z10/SZM/2T	80	6500K	128

Series For 2700K 120Lm

Product	CRI Min. ⁽¹⁾	CCT(K)	Φ(lm) Min. ⁽²⁾
67-23ST/KKE-N2712096Z10/SZM/2T	80	2700K	120
67-23ST/KKE-N3012796Z10/SZM/2T	80	3000K	127
67-23ST/KKE-N4013396Z10/SZM/2T	80	4000K	133
67-23ST/KKE-N5013396Z10/SZM/2T	80	5000K	133
67-23ST/KKE-N5713396Z10/SZM/2T	80	5700K	133
67-23ST/KKE-N6513396Z10/SZM/2T	80	6500K	133

Series For 2700K 125Lm

Product	CRI Min. ⁽¹⁾	CCT(K)	Φ(lm) Min. ⁽²⁾
67-23ST/KKE-N2712596Z10/SZM/2T	80	2700K	125
67-23ST/KKE-N3013296Z10/SZM/2T	80	3000K	132
67-23ST/KKE-N4013896Z10/SZM/2T	80	4000K	138
67-23ST/KKE-N5013896Z10/SZM/2T	80	5000K	138
67-23ST/KKE-N5713896Z10/SZM/2T	80	5700K	138
67-23ST/KKE-N6513896Z10/SZM/2T	80	6500K	138

Notes:

1. Tolerance of Color Rendering Index: ± 2
2. Tolerance of Luminous flux: $\pm 11\%$.

EVERLIGHT

Device Selection Guide

Chip Materials	Emitted Color	Resin Color
InGaN	Cool White Neutral White Warm White	Water Clear

Absolute Maximum Ratings (T_{Soldering}=25°C)

Parameter	Symbol	Rating	Unit
Forward Current	I _F	120	mA
Peak Forward Current (Duty 1/10 @10ms)	I _{FP}	240	mA
Power Dissipation	P _d	1152	mW
Operating Temperature	T _{opr}	-40 ~ +85	°C
Storage Temperature	T _{stg}	-40 ~ +100	°C
Thermal Resistance (Junction / Soldering point)	R _{th J-S}	17	°C/W
Junction Temperature	T _j	115	°C
Soldering Temperature	T _{sol}	Reflow Soldering : 260 °C for 10 sec. Hand Soldering : 350 °C for 3 sec.	

Note:
The products are sensitive to static electricity and must be carefully taken when handling products

Electro-Optical Characteristics (T_{Soldering}=25°C)

Parameter	Symbol	Min.	Typ.	Max.	Unit	Condition
Luminous Flux ₍₁₎	Φ	105	-----	-----	lm	I _F =100mA
Forward Voltage ₍₂₎	V _F	8.7	-----	9.6	V	I _F =100mA
Color Rendering Index ₍₃₎	R _a	80	-----	-----		I _F =100mA
	R ₉	0	-----	-----		I _F =100mA
Viewing Angle	2θ _{1/2}	-----	120	-----	deg	I _F =100mA

- Notes:
1. Tolerance of Luminous flux: ±11%.
2. Tolerance of Forward Voltage: ±0.1V.
3. Tolerance of Color Rendering Index: ±2

Bin Range of Luminous Flux

Series For 2700K 110Lm

■ **2200K**

Bin Code	Min.	Max.	Unit	Condition
S1A	105	110	lm	I _F =100mA
S2A	110	115		
S2B	115	120		

■ **2700K**

Bin Code	Min.	Max.	Unit	Condition
S2A	110	115	lm	I _F =100mA
S2B	115	120		
S3A	120	125		

■ **3000K**

Bin Code	Min.	Max.	Unit	Condition
S1720	117	120	lm	I _F =100mA
S3A	120	125		
S3B	125	130		

■ **4000K~6500K**

Bin Code	Min.	Max.	Unit	Condition
S2325	123	125	lm	I _F =100mA
S3B	125	130		
S4A	130	135		

Series For 2700K 115Lm

■ 2700K

Bin Code	Min.	Max.	Unit	Condition
S2B	115	120	lm	I _F =100mA
S3A	120	125		
S3B	125	130		

■ 3000K

Bin Code	Min.	Max.	Unit	Condition
S2225	122	125	lm	I _F =100mA
S3B	125	130		
S4A	130	135		

■ 4000K~6500K

Bin Code	Min.	Max.	Unit	Condition
S2830	128	130	lm	I _F =100mA
S4A	130	135		
S4B	135	140		

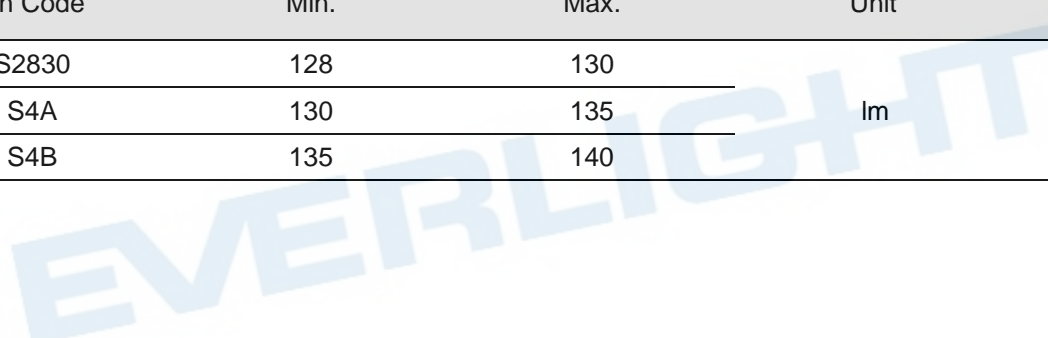

Series For 2700K 120Lm

■ 2700K

Bin Code	Min.	Max.	Unit	Condition
S3A	120	125	lm	I _F =100mA
S3B	125	130		
S4A	130	135		

■ 3000K

Bin Code	Min.	Max.	Unit	Condition
S2730	127	130	lm	I _F =100mA
S4A	130	135		
S4B	135	140		

■ 4000K~6500K

Bin Code	Min.	Max.	Unit	Condition
S3335	133	135	lm	I _F =100mA
S4B	135	140		
S5A	140	145		

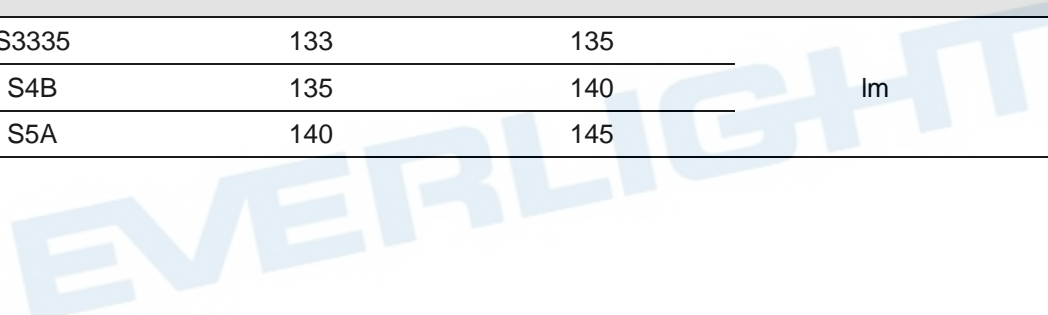

Series For 2700K 125Lm

■ 2700K

Bin Code	Min.	Max.	Unit	Condition
S3B	125	130	lm	I _F =100mA
S4A	130	135		
S4B	135	140		

■ 3000K

Bin Code	Min.	Max.	Unit	Condition
S3235	132	135	lm	I _F =100mA
S4B	135	140		
S5A	140	145		

■ 4000K~6500K

Bin Code	Min.	Max.	Unit	Condition
S3840	138	140	lm	I _F =100mA
S5A	140	145		
S5B	145	150		

Note:
 Tolerance of Luminous flux: ±11%.

Bin Range of Forward Voltage

Group	Bin Code	Min.	Max.	Unit	Condition
8796	87C	8.7	9.0	V	I _F =100mA
	90C	9.0	9.3		
	93C	9.3	9.6		

Note:
 Tolerance of Forward Voltage : ±0.1V.

The C.I.E. 1931 Chromaticity Diagram

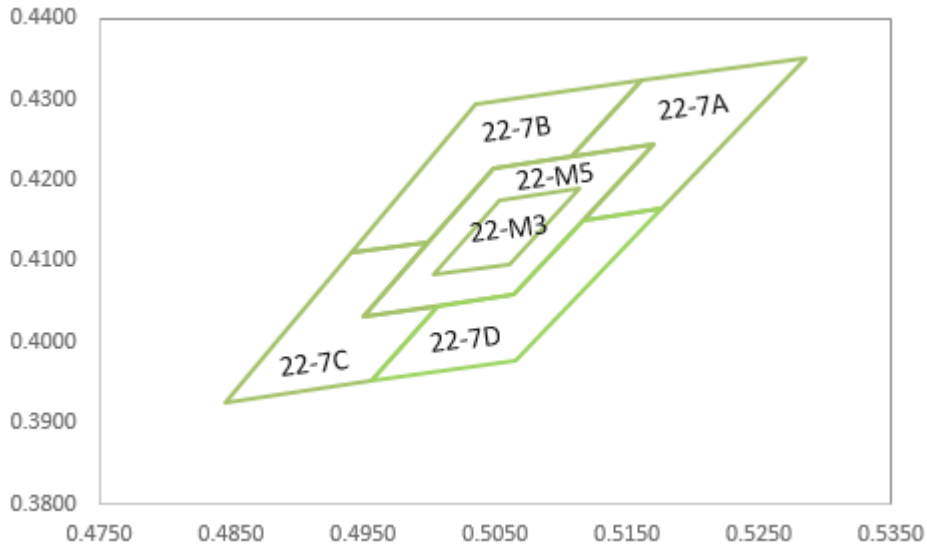

Bin Range of 3 STEP

CCT	Bin Code	CIE_x	CIE_y
2200K	22-M3	0.5053	0.4176
		0.5113	0.4190
		0.5061	0.4097
		0.5003	0.4084
Reference Range:2170K~2205K			

Bin Range of 5 STEP

CCT	Bin Code	CIE_x	CIE_y
2200K	22-M5	0.5169	0.4244
		0.5048	0.4216
		0.4949	0.4031
		0.5063	0.4058
Reference Range:2154K~2223K			

Bin Range of Chromaticity Coordinates

CCT	Bin Code	CIE_x	CIE_y	Bin Code	CIE_x	CIE_y	
2200K	22-7A	0.5160	0.4323	22-7D	0.5116	0.4151	
		0.5285	0.4352		0.5175	0.4165	
		0.5175	0.4165		0.5065	0.3977	
		0.5116	0.4151		0.4955	0.3952	
		0.5169	0.4244		0.5006	0.4044	
		0.5108	0.4230		0.5063	0.4058	
	Reference Range:2119K~2162K						
	22-7B	0.5034	0.4293	22-7C	0.4940	0.4110	
		0.5160	0.4323		0.4998	0.4123	
		0.5108	0.4230		0.4949	0.4031	
		0.5048	0.4216		0.5006	0.4044	
		0.4998	0.4123		0.4955	0.3952	
		0.4940	0.4110		0.4845	0.3926	
	Reference Range:2213K~2258K						

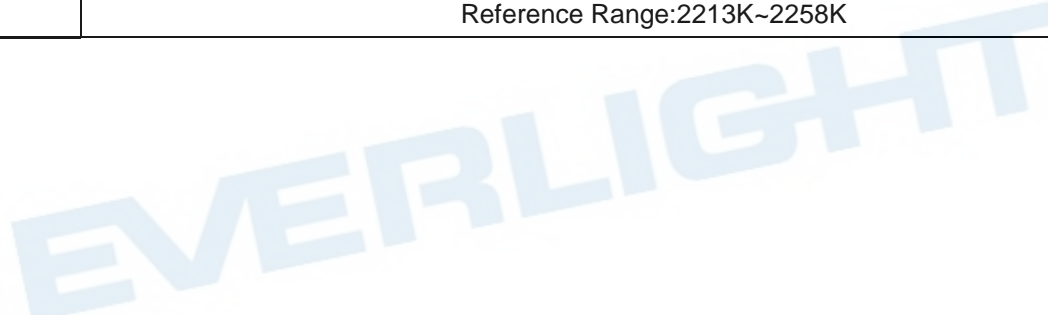

The C.I.E. 1931 Chromaticity Diagram

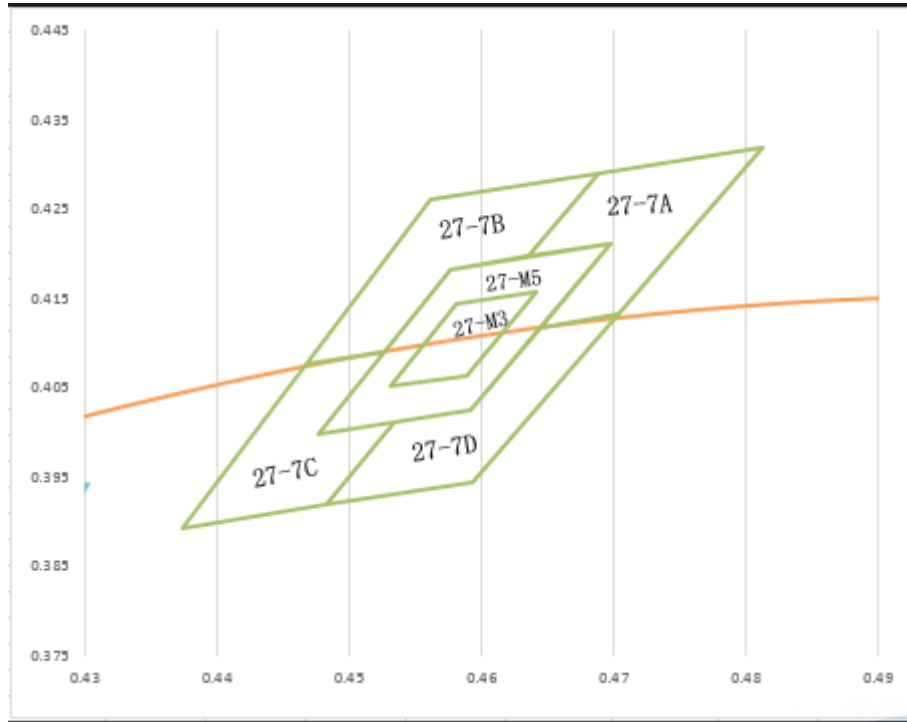

Bin Range of 3 STEP

CCT	Bin Code	CIE_x	CIE_y
2700K	27-M3	0.4581	0.4143
		0.4641	0.4157
		0.4589	0.4064
		0.4531	0.4051
Reference Range:2681K~2754K			

Bin Range of 5 STEP

CCT	Bin Code	CIE_x	CIE_y
2700K	27-M5	0.4697	0.4211
		0.4576	0.4183
		0.4477	0.3998
		0.4591	0.4025
Reference Range:2647K~2792K			

Bin Range of Chromaticity Coordinates

CCT	Bin Code	CIE_x	CIE_y	Bin Code	CIE_x	CIE_y	
2700K	27-7A	0.4688	0.429	27-7D	0.4644	0.4118	
		0.4813	0.4319		0.4703	0.4132	
		0.4703	0.4132		0.4593	0.3944	
		0.4644	0.4118		0.4483	0.3919	
		0.4697	0.4211		0.4534	0.4011	
		0.4636	0.4197		0.4591	0.4025	
	Reference Range:2580K~2718K						
	27-7B	0.4562	0.426	27-7C	0.4468	0.4077	
		0.4688	0.429		0.4526	0.409	
		0.4636	0.4197		0.4477	0.3998	
		0.4576	0.4183		0.4534	0.4011	
		0.4526	0.409		0.4483	0.3919	
0.4468		0.4077	0.4373		0.3893		
Reference Range:2718K~2868K							

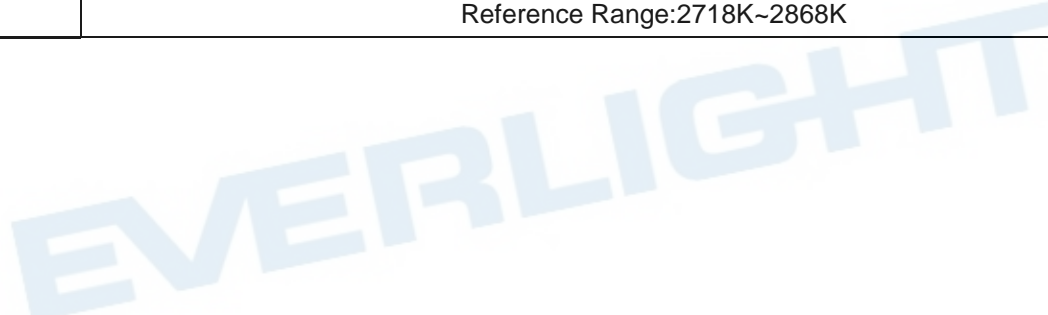

The C.I.E. 1931 Chromaticity Diagram

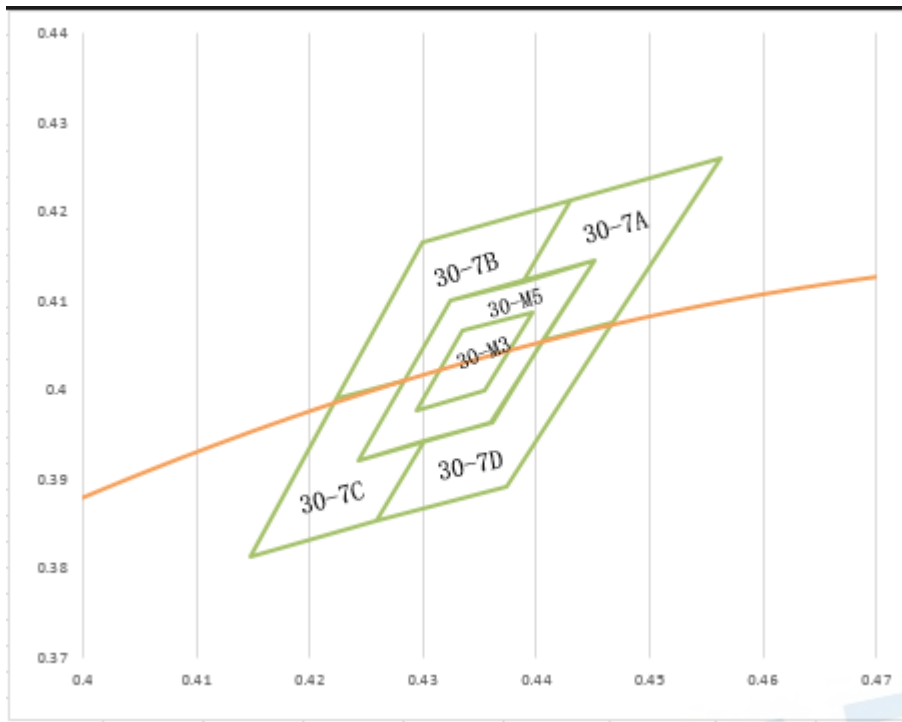

Bin Range of 3 STEP

CCT	Bin Code	CIE_x	CIE_y
3000K	30-M3	0.4335	0.4067
		0.4294	0.3978
		0.4354	0.3999
		0.4396	0.4088
Reference Range:2979K~3059K			

Bin Range of 5 STEP

CCT	Bin Code	CIE_x	CIE_y
3000K	30-M5	0.4451	0.4145
		0.4324	0.41
		0.4243	0.3922
		0.436	0.3964
Reference Range:2941K~3105K			

Bin Range of Chromaticity Coordinates

CCT	Bin Code	CIE_x	CIE_y	Bin Code	CIE_x	CIE_y	
3000K	30-7A	0.443	0.4212	30-7D	0.4406	0.4055	
		0.4387	0.4122		0.4468	0.4077	
		0.4451	0.4145		0.4373	0.3893	
		0.4406	0.4055		0.4259	0.3853	
		0.4468	0.4077		0.4302	0.3943	
		0.4562	0.426		0.4361	0.3964	
	Reference Range:2868K~3019K						
	30-7B	0.443	0.4212	30-7C	0.4284	0.4011	
		0.4299	0.4165		0.4223	0.399	
		0.4223	0.399		0.4147	0.3814	
		0.4284	0.4011		0.4259	0.3853	
		0.4324	0.41		0.4302	0.3943	
0.4387		0.4122	0.4243		0.3922		
Reference Range:3019K~3208K							

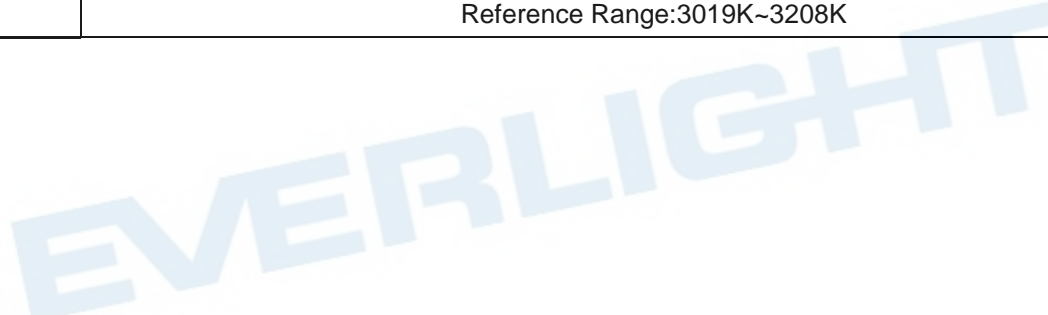

The C.I.E. 1931 Chromaticity Diagram

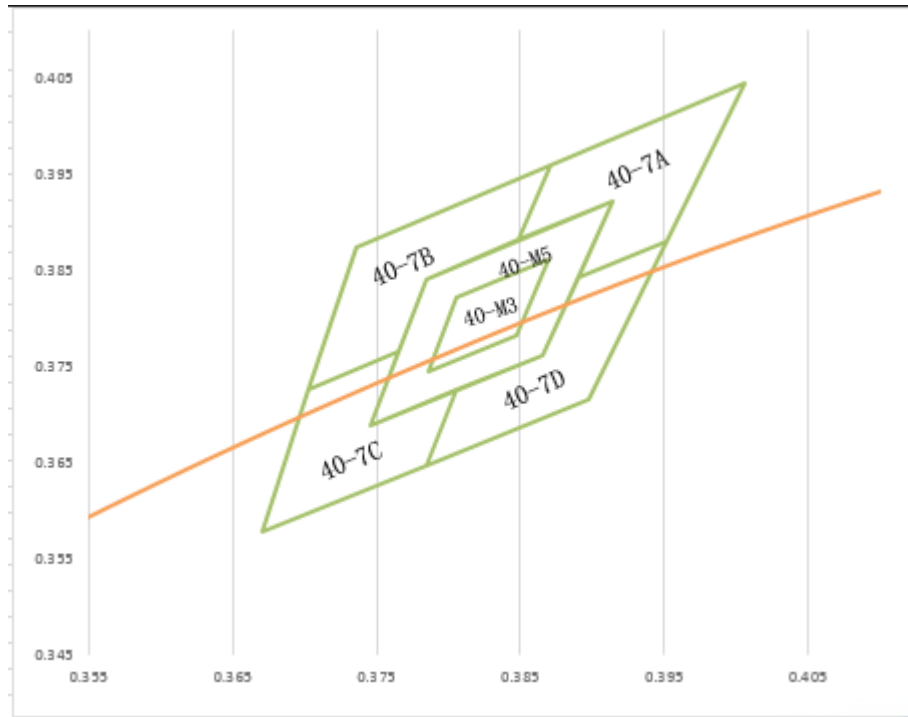

Bin Range of 3 STEP

CCT	Bin Code	CIE_x	CIE_y
4000K	40-M3	0.3806	0.3823
		0.3786	0.3746
		0.3847	0.3783
		0.387	0.3862
Reference Range:3897K~4036K			

CCT	Bin Code	CIE_x	CIE_y
4000K	40-M5	0.3914	0.3922
		0.3784	0.3841
		0.3746	0.3689
		0.3865	0.3762
Reference Range:3832K~4107K			

Bin Range of Chromaticity Coordinates

CCT	Bin Code	CIE_x	CIE_y	Bin Code	CIE_x	CIE_y	
4000K	40-7A	0.3871	0.3959	40-7D	0.389	0.3842	
		0.3849	0.3882		0.3952	0.3881	
		0.3914	0.3922		0.3897	0.3716	
		0.389	0.3842		0.3784	0.3647	
		0.3952	0.3881		0.3806	0.3726	
		0.4006	0.4044		0.3865	0.3762	
	Reference Range:3709K~3965K						
	40-7B	0.3871	0.3959	40-7C	0.3765	0.3765	
		0.3736	0.3874		0.3703	0.3727	
		0.3703	0.3727		0.367	0.3578	
		0.3765	0.3765		0.3784	0.3647	
		0.3784	0.3841		0.3806	0.3726	
0.3849		0.3882	0.3746		0.3689		
Reference Range:3965K~4259K							

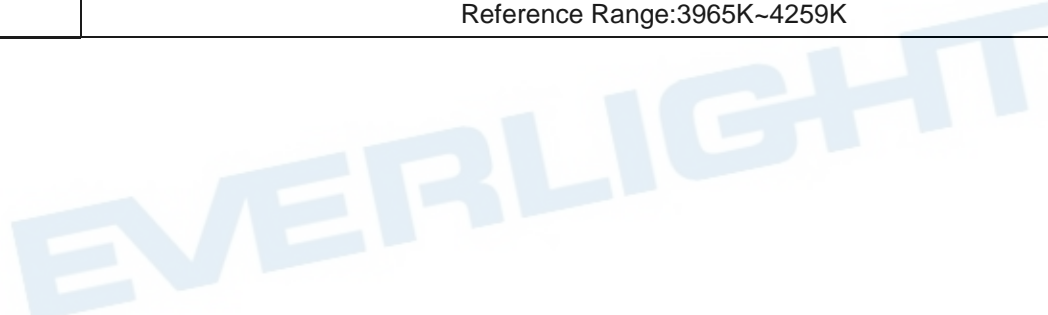

The C.I.E. 1931 Chromaticity Diagram

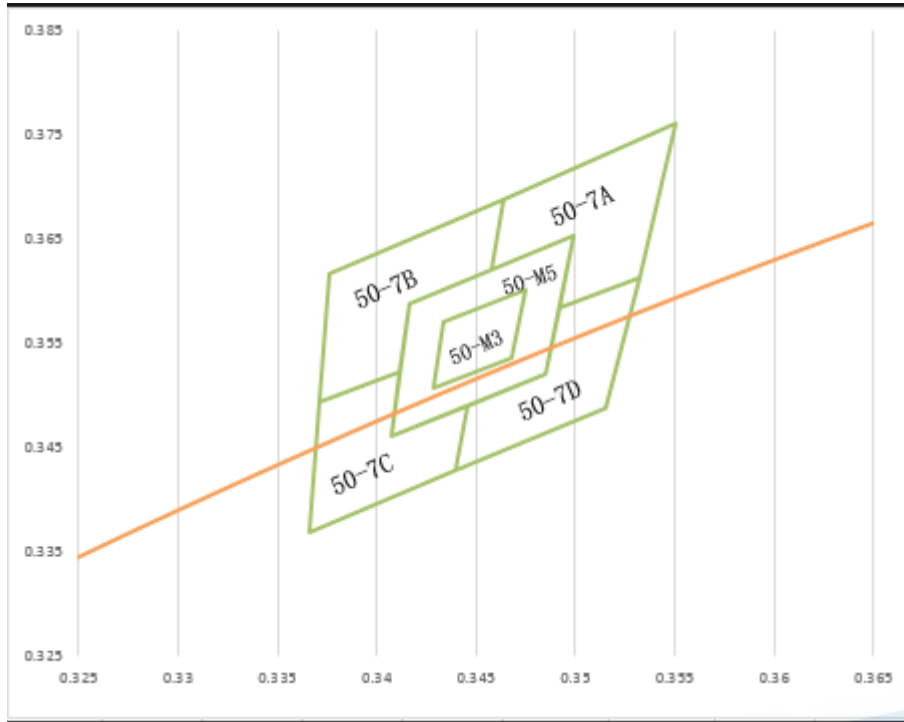

Bin Range of 3 STEP

CCT	Bin Code	CIE_x	CIE_y
5000K	50-M3	0.3434	0.3571
		0.3475	0.3602
		0.3468	0.3536
		0.3429	0.3507
Reference Range:4940K~5082K			

Bin Range of 5 STEP

CCT	Bin Code	CIE_x	CIE_y
5000K	50-M5	0.3499	0.3653
		0.3416	0.3587
		0.3407	0.3461
		0.3485	0.352
Reference Range:4872K~5156K			

Bin Range of Chromaticity Coordinates

CCT	Bin Code	CIE_x	CIE_y	Bin Code	CIE_x	CIE_y	
5000K	50-7A	0.3464	0.3688	50-7D	0.3492	0.3583	
		0.3551	0.376		0.3532	0.3613	
		0.3532	0.3613		0.3515	0.3487	
		0.3492	0.3583		0.344	0.3428	
		0.3499	0.3653		0.3446	0.349	
		0.3458	0.362		0.3485	0.352	
	Reference Range:4743K~5008K						
	50-7B	0.3376	0.3616	50-7C	0.3371	0.3493	
		0.3464	0.3688		0.3411	0.3523	
		0.3458	0.362		0.3407	0.3461	
		0.3416	0.3587		0.3446	0.349	
		0.3411	0.3523		0.344	0.3428	
0.3371		0.3493	0.3366		0.3369		
Reference Range:5008K~5309K							

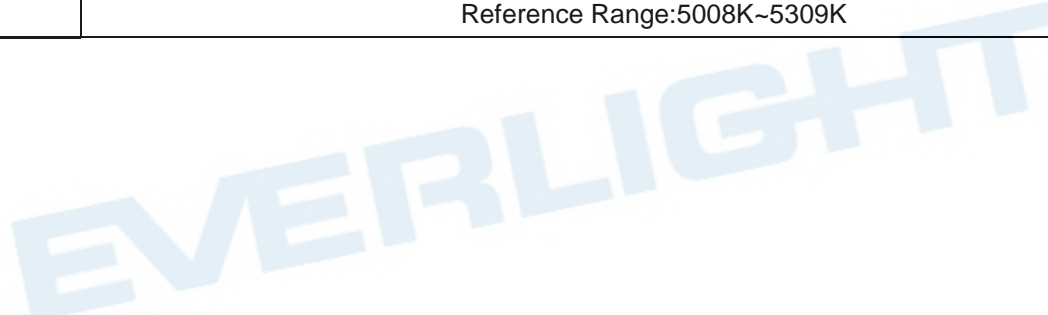

The C.I.E. 1931 Chromaticity Diagram

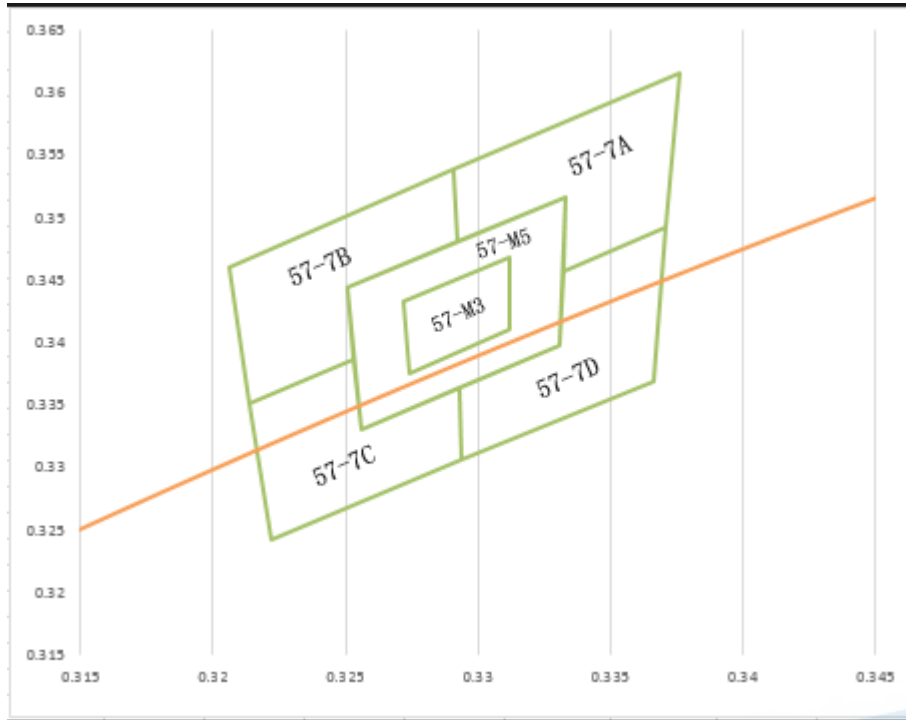

Bin Range of 3 STEP

CCT	Bin Code	CIE_x	CIE_y
5700K	57-M3	0.3272	0.3433
		0.3312	0.3469
		0.3312	0.341
		0.3274	0.3376
Reference Range:5553K~5731K			

Bin Range of 5 STEP

CCT	Bin Code	CIE_x	CIE_y
5700K	57-M5	0.3333	0.3517
		0.3251	0.3444
		0.3256	0.3331
		0.3331	0.3397
Reference Range:5466K~5823K			

Bin Range of Chromaticity Coordinates

CCT	Bin Code	CIE_x	CIE_y	Bin Code	CIE_x	CIE_y	
5700K	57-7A	0.3291	0.3539	57-7D	0.3332	0.3457	
		0.3376	0.3616		0.3371	0.3493	
		0.3371	0.3493		0.3366	0.3369	
		0.3332	0.3457		0.3294	0.3306	
		0.3333	0.3517		0.3293	0.3364	
		0.3292	0.3481		0.3331	0.3397	
	Reference Range:5308K~5639K						
	57-7B	0.3206	0.3461	57-7C	0.3214	0.3352	
		0.3291	0.3539		0.3253	0.3387	
		0.3292	0.3481		0.3256	0.3331	
		0.3251	0.3444		0.3293	0.3364	
		0.3253	0.3387		0.3294	0.3306	
0.3214		0.3352	0.3222		0.3243		
Reference Range:5639K~6022K							

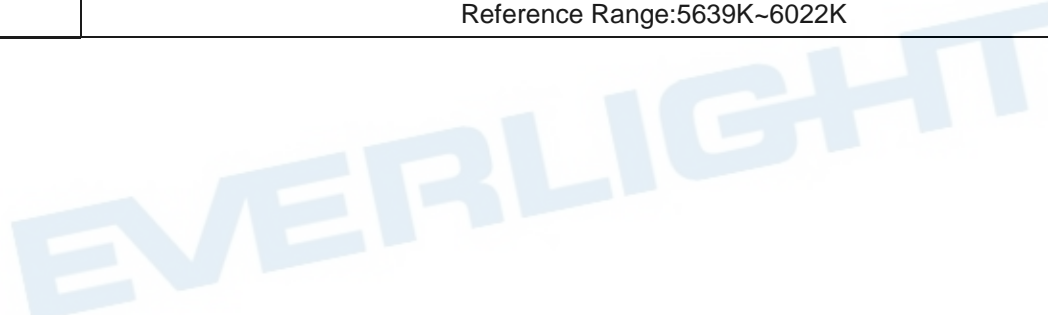

The C.I.E. 1931 Chromaticity Diagram

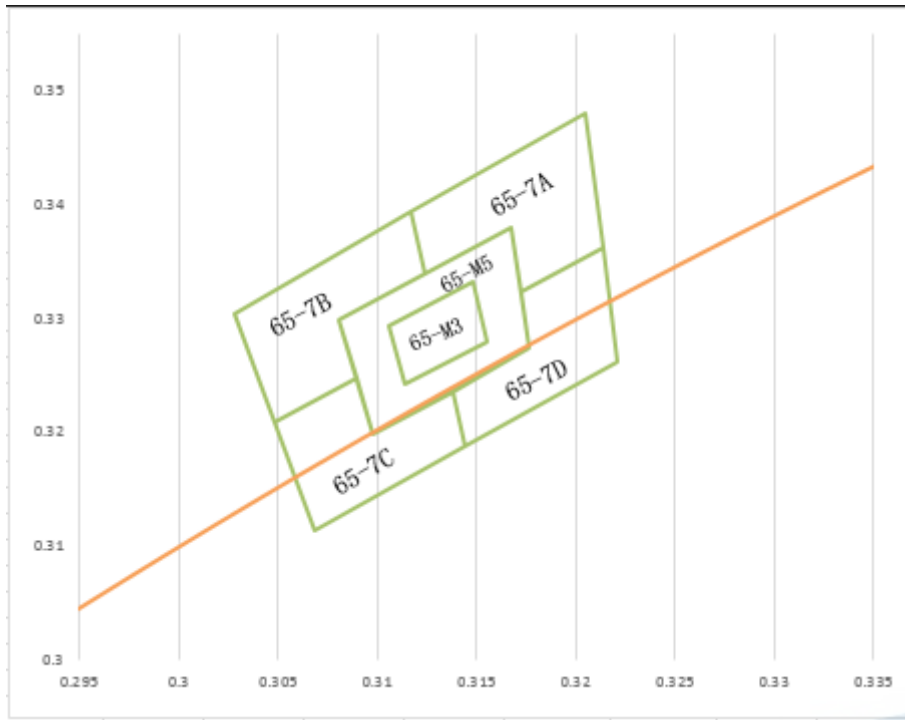

Bin Range of 3 STEP

CCT	Bin Code	CIE_x	CIE_y
6500K	65-M3	0.3106	0.3293
		0.3148	0.3332
		0.3155	0.328
		0.3114	0.3242
Reference Range:6359K~6617K			

Bin Range of 5 STEP

CCT	Bin Code	CIE_x	CIE_y
6500K	65-M5	0.3167	0.338
		0.3081	0.3298
		0.3098	0.3198
		0.3177	0.3274
Reference Range:6240K~6752K			

Bin Range of Chromaticity Coordinates

CCT	Bin Code	CIE_x	CIE_y	Bin Code	CIE_x	CIE_y	
6500K	65-7A	0.3117	0.3393	65-7D	0.3172	0.3324	
		0.3205	0.3481		0.3214	0.3362	
		0.3214	0.3362		0.3221	0.3261	
		0.3172	0.3324		0.3144	0.3187	
		0.3167	0.338		0.3138	0.3236	
		0.3124	0.3339		0.3177	0.3274	
	Reference Range:6017K~6484K						
	65-7B	0.3028	0.3304	65-7C	0.3048	0.3209	
		0.3117	0.3393		0.309	0.3247	
		0.3124	0.3339		0.3098	0.3198	
		0.3081	0.3298		0.3138	0.3236	
		0.309	0.3247		0.3144	0.3187	
		0.3048	0.3209		0.3068	0.3113	
	Reference Range:6482K~7042K						

Notes:

1. The value is based on driving current by 100mA.
2. Tolerance of Chromaticity Coordinates: ± 0.01 .
3. Bin Range of 3step & 5step can be shipped directly, 7A:7C and 7B:7D must be shipped in 1:1

Spectrum Distribution

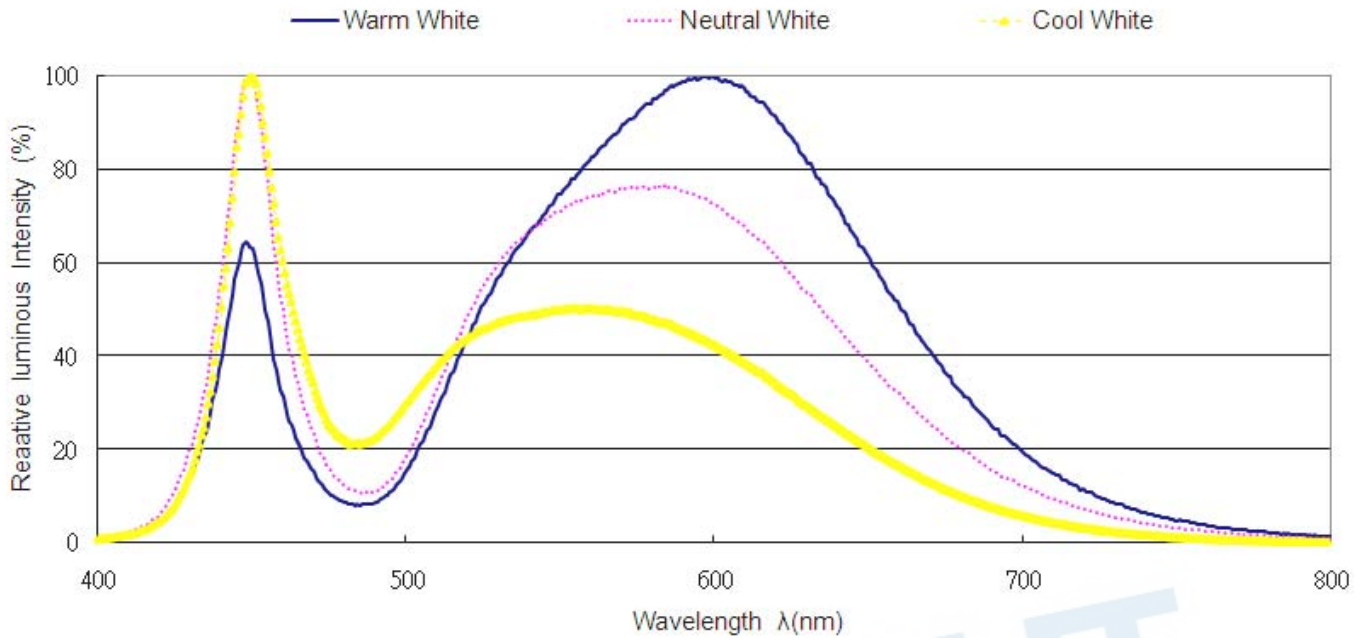

Typical Electro-Optical Characteristics Curves

Fig.1 – Forward Voltage Shift vs. Junction Temperature

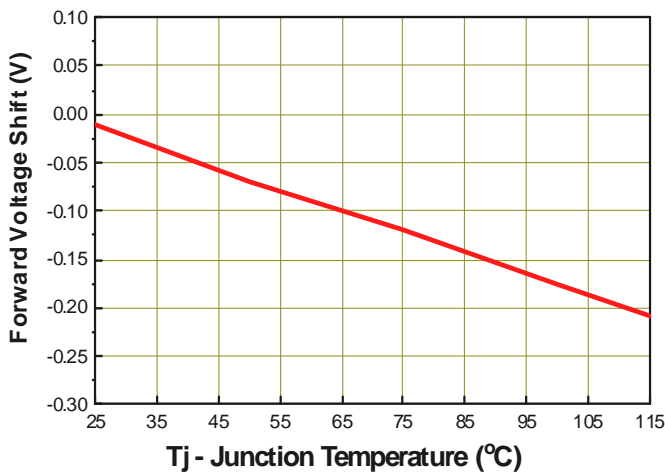
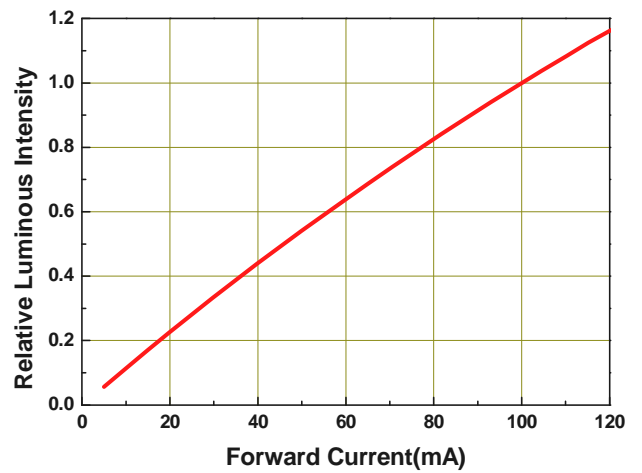

Fig.2 - Relative Luminous Intensity vs. Forward Current



Typical Electro-Optical Characteristics Curves

Fig.3 - Relative Luminous Intensity vs. Junction Temperature

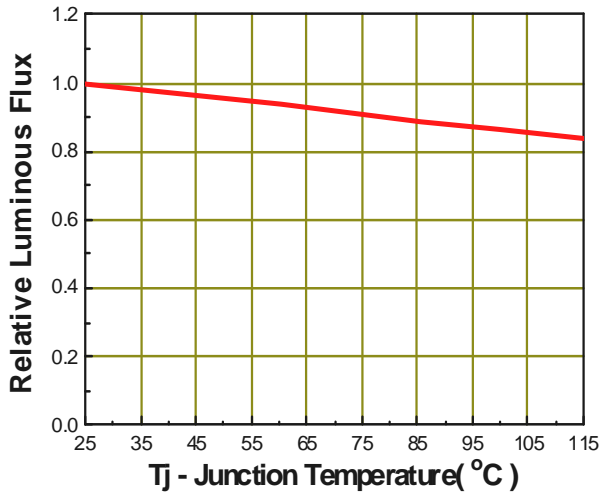

Fig.4 - Forward Current vs. Forward Voltage

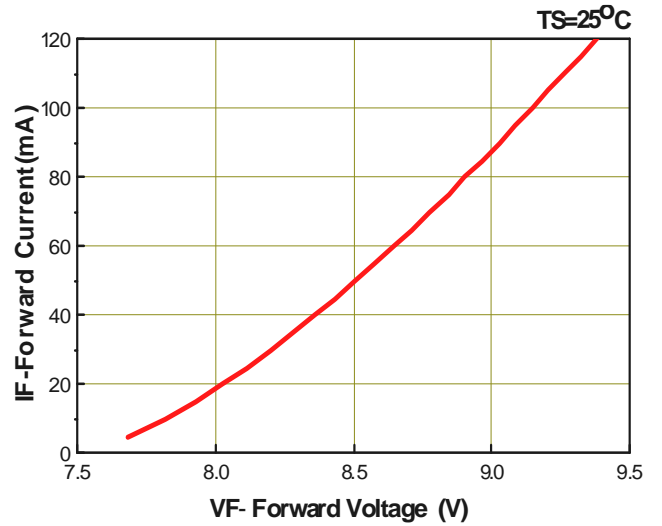

Fig.5 – Max. Driving Forward Current vs. Soldering Temperature

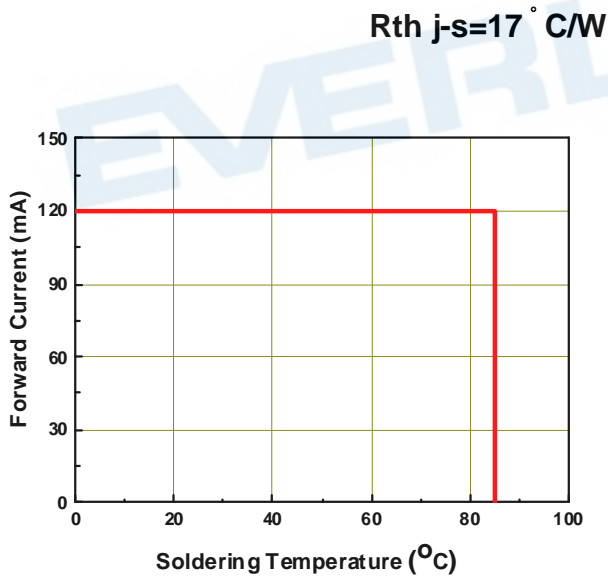
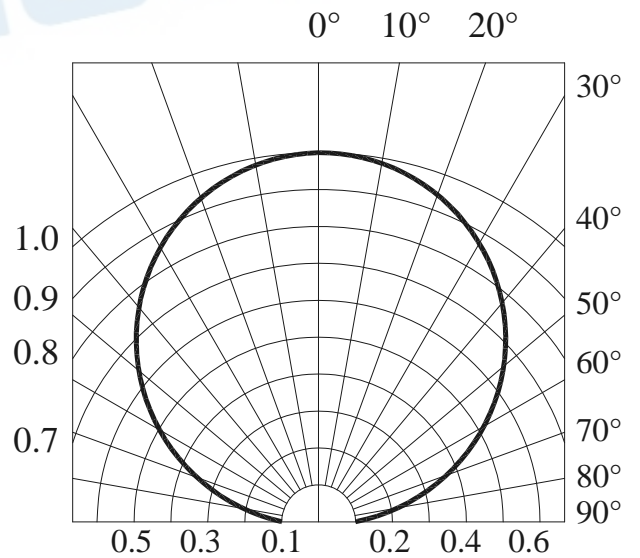
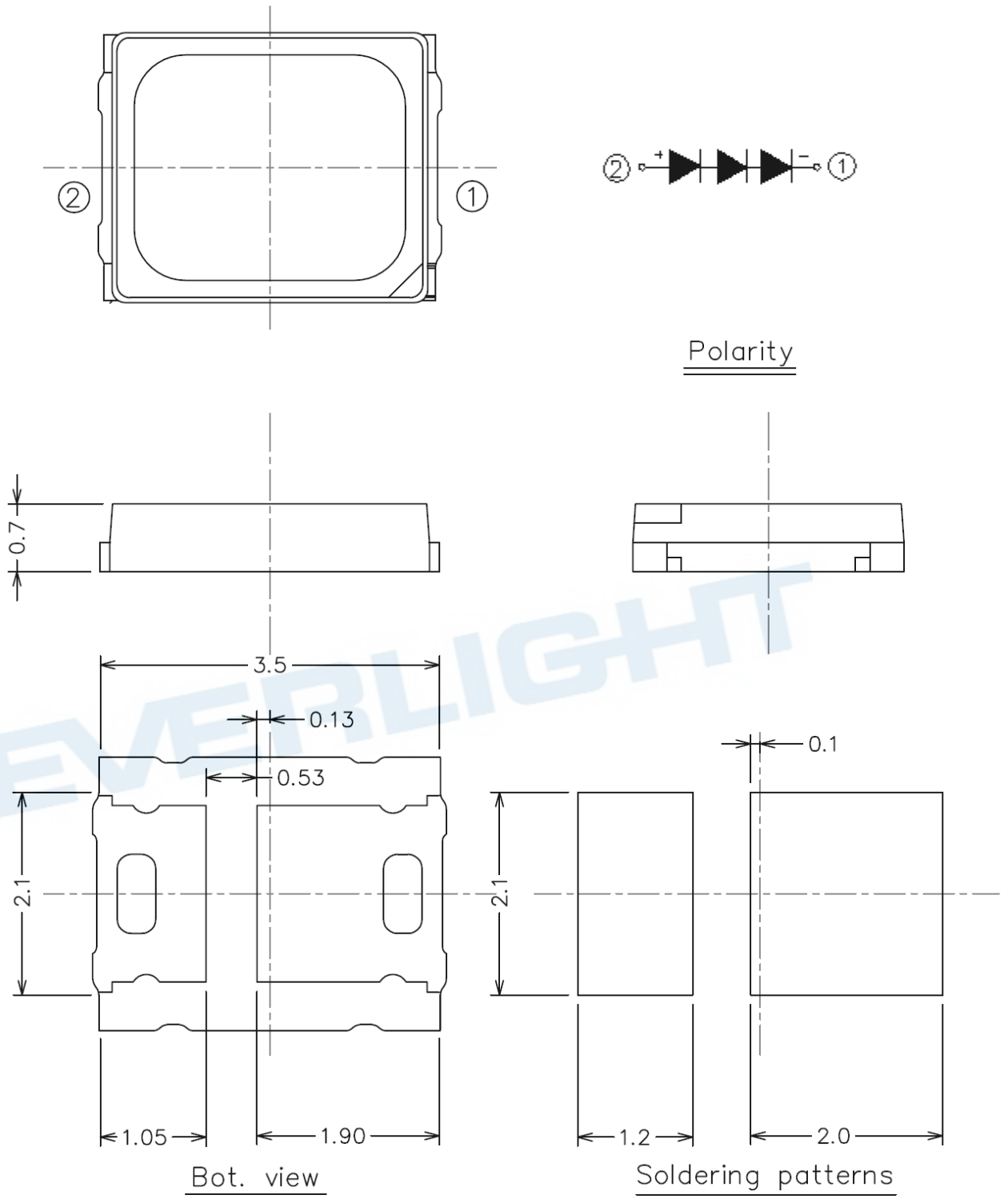

Fig.6 – Radiation Diagram



Package Dimension



Note:
Tolerance unless mentioned is ± 0.15 mm; Unit = mm

Moisture Resistant Packing Materials

Label Explanation

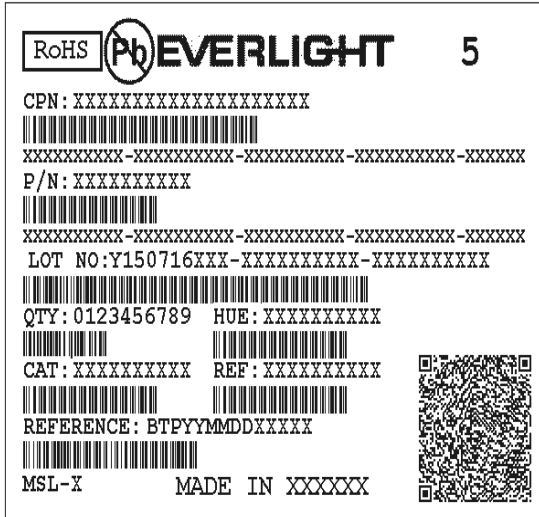

- CPN: Customer's Product Number
- P/N: Product Number
- QTY: Packing Quantity
- CAT: Luminous Intensity Rank
- HUE: Dom. Wavelength Rank
- REF: Forward Voltage Rank
- LOT No: Lot Number

Reel Dimensions

1. Carrier Tape Dimensions:

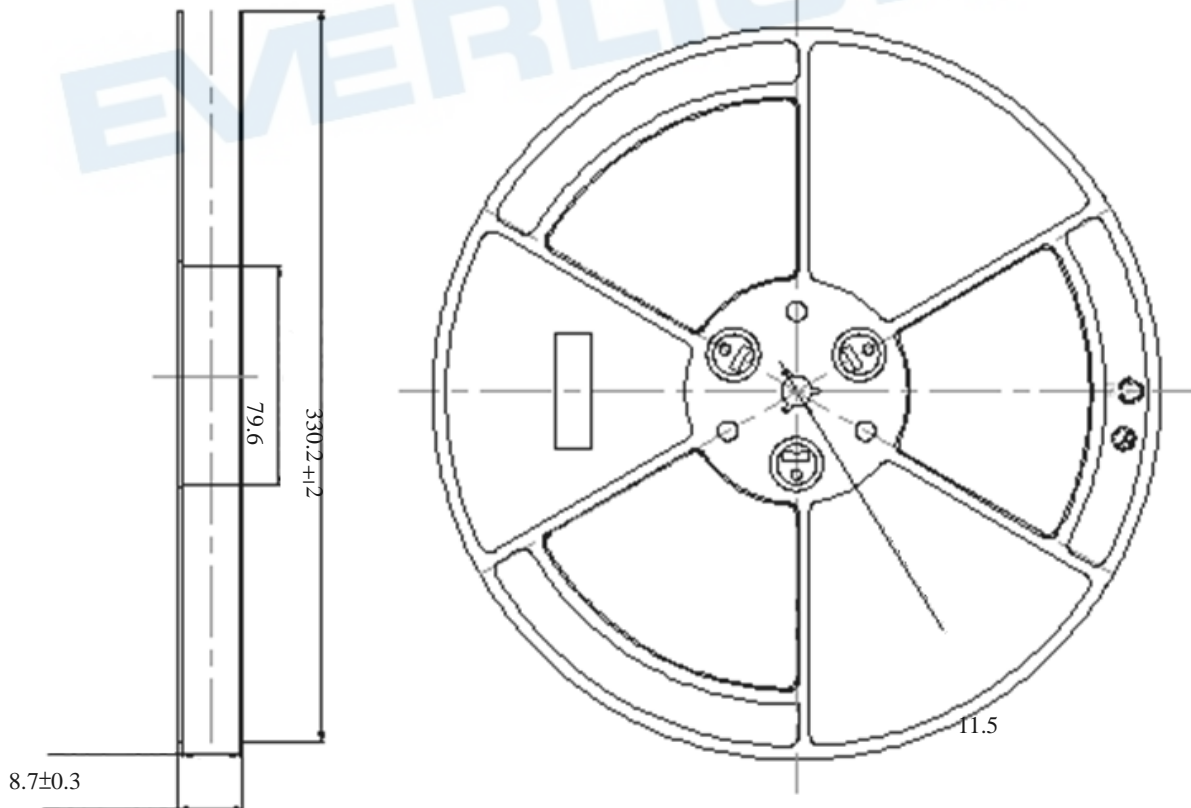

1-1. Loaded Quantity 16000 pcs Per Reel

2.Carrier Tape Dimensions:

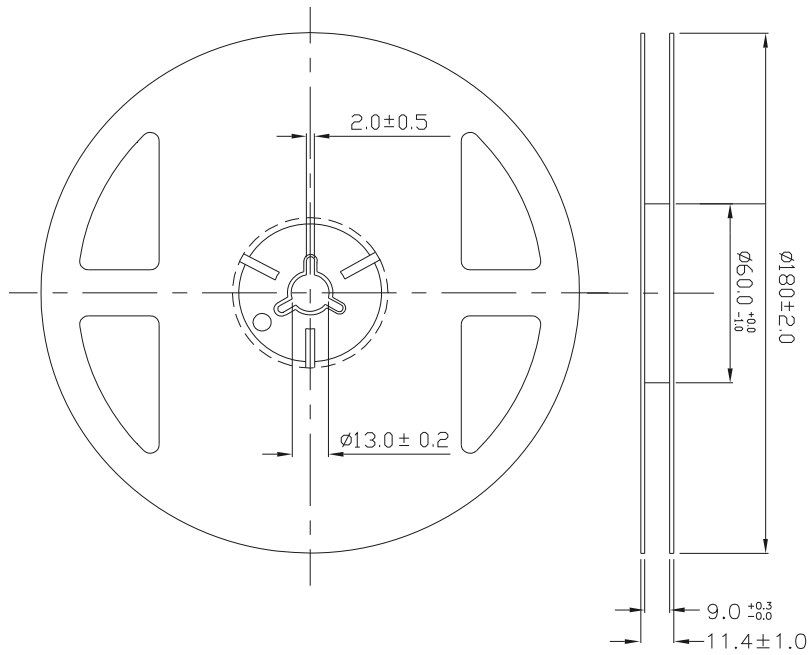

2-1.Loaded Quantity 2000/4000 pcs Per Reel

Note:

Tolerances unless mentioned ± 0.1 mm. Unit = mm

Reliability Test Items and Conditions

The reliability of products shall be satisfied with items listed below.
 Confidence level : 90%
 LTPD : 10%

No.	Items	Test Condition	Test Hours/Cycles	Sample Size	Ac/Re
1	Resistance to Solder Heat	Temp. : 260°C/10sec.	3 Times.	8 PCS.	0/1
2	Temperature Cycle	-40°C~100°C / Dwell time 30min	200 Cycles	8 PCS.	0/1
3	High Temperature/Humidity Life	Ta=85°C,85%RH, I _F = 120mA	1000 Hrs.	8 PCS.	0/1
4	Low Temperature Life	Ta=-40°C, I _F = 120 mA	1000 Hrs.	8 PCS.	0/1
5	High Temperature Life	Ta=60°C, I _F =120 mA	3000 Hrs.	8 PCS.	0/1
6	High Temperature Life	Ta=85°C, I _F =120 mA	3000 Hrs.	8 PCS.	0/1
7	Pulse	ON 30ms / OFF 2500ms	30000 CYCLES	8 PCS.	0/1
8	Thermal Shock	H : +100°C 20min ∩ 10 sec L : -40°C 20min	200 Cycles	8 PCS.	0/1
9	Power Temperature Cycle	H : +100°C 15min ∩ 5 min L : -40°C 15min I _F = 80 mA	200 Cycles	8 PCS.	0/1

Precautions for Use

1. Over-current-proof

Customer must apply resistors for protection; otherwise slight voltage shift will cause big current change (Burn out will happen).

2. Storage

2.1 Do not open moisture proof bag before the products are ready to use.

2.2 Before opening the package: The LEDs should be kept at 30°C or less and 90%RH or less.

2.3 After opening the package: The LED's floor life is 168 Hrs under 30°C or less and 60% RH or less. If unused LEDs remain, it should be stored in moisture proof packages.

2.4 If the moisture absorbent material (silica gel) has faded away or the LEDs have exceeded the storage time, baking treatment should be performed using the following conditions.

Baking treatment: 60±5°C for 24 hours.

3. Soldering Condition

3.1 Pb-free solder temperature profile

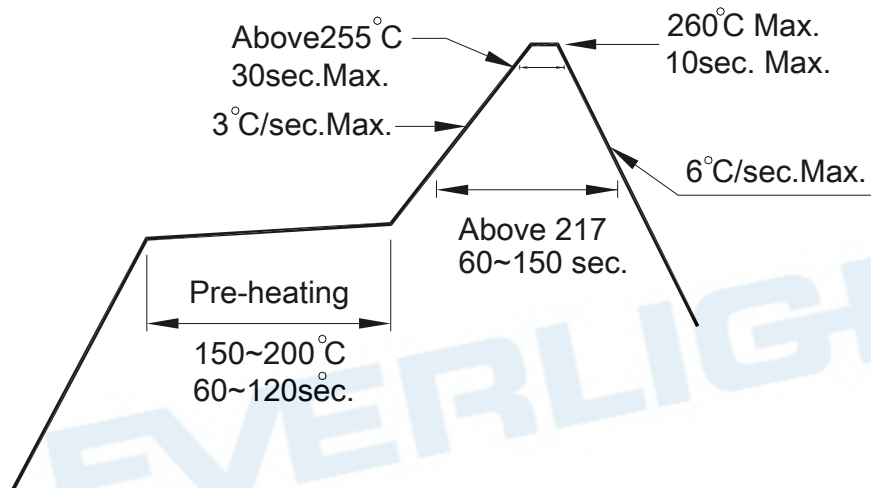

3.2 Reflow soldering should not be done more than two times.

3.3 When soldering, do not put stress on the LEDs during heating.

3.4 After soldering, do not warp the circuit board.

4. Soldering Iron

Each terminal is to go to the tip of soldering iron temperature less than 350°C for 3 seconds within once in less than the soldering iron capacity 25W. Leave two seconds and more intervals, and do soldering of each terminal. Be careful because the damage of the product is often started at the time of the hand solder.

5. Repairing

Repair should not be done after the LEDs have been soldered. When repairing is unavoidable, a double-head soldering iron should be used (as below figure). It should be confirmed beforehand whether the characteristics of the LEDs will or will not be damaged by repairing.

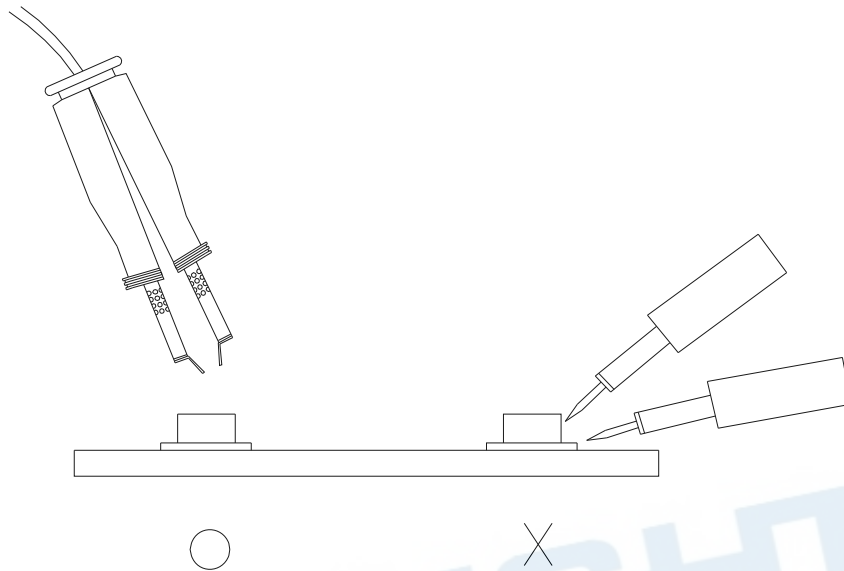

DISCLAIMER

1. EVERLIGHT reserves the right(s) on the adjustment of product material mix for the specification.
2. The product meets EVERLIGHT published specification for a period of twelve (12) months from date of shipment.
3. The graphs shown in this datasheet are representing typical data only and do not show guaranteed values.
4. When using this product, please observe the absolute maximum ratings and the instructions for using outlined in these specification sheets. EVERLIGHT assumes no responsibility for any damage resulting from the use of the product which does not comply with the absolute maximum ratings and the instructions included in these specification sheets.
5. These specification sheets include materials protected under copyright of EVERLIGHT. Reproduction in any form is prohibited without obtaining EVERLIGHT's prior consent.
6. This product is not intended to be used for military, aircraft, automotive, medical,

EVERLIGHT

X-ON Electronics

Largest Supplier of Electrical and Electronic Components

Click to view similar products for [everlight](#) manufacturer:

Other Similar products are found below :

[11-21/R8C-AP1Q2B/2T](#) [HLMP4719](#) [ELSH-F71G1-0LPNM-CG2G3](#) [MAN6760](#) [EL3063S1\(TA\)](#) [EL452\(TA\)-VG](#) [EL-17-21SURC/S530-A2/TR8](#) [4N35S\(TA\)](#) [A694B/2SUR/S530-A3](#) [22-23C/R6GHBHW-C01/2C](#) [MV64521](#) [11-21SURC-S530-A3-TR8](#) [12-22SDRSYGC/S530-A3/E3/TR8](#) [IR383C](#) [MV53123](#) [HLMP2785](#) [ELSH-Q61F1-0LPNM-JF3F8](#) [MAN6940](#) [ELSW-J11C1-0CPGS-C5700](#) [MV5464MP4B](#) [204-10SUGC/S400-A4-L](#) [12-21/BHC-AP1Q2M/2C](#) [ELSH-F81M1-0CPGS-C3000](#) [PD15-21C/TR8](#) [45-21SCUM2C/L1720NE6/TR8-T](#) [EADCT056RA1](#) [61-238/LK2C-B50638F6GB2/ET](#) [HLMP-2550](#) [IR67-21C/L261/S65/TR8](#) [4N25M](#) [19-213SYGC/S530-E2/TR8](#) [IR333C-F-A](#) [264-7ID](#) [45-11-BFSB-49373902E-2T8-AM](#) [MSQC4411C](#) [PD95-21B/TR10](#) [IRM-H920J5/TR2](#) [EL814](#) [1254-10SURT/S530-A3](#) [ITR9702-F](#) [67-21/T2C-ZV1W2E/2T](#) [EL827](#) [MV8411](#) [67-31EP6-UYD8395DAFAZ5-ET0D-AM](#) [EL3083](#) [45-21UYC/S530-A3/TR8](#) [IR908-7C\(E4\)](#) [ITR9707](#) [ELSH-F41R1-0LPNM-AR5R6](#) [99-616LM2C/L7580S76/TR8-T/ES](#)