

## Technical Data Sheet

---

### 7343/Y7C2-AQSB/P/MS

#### Features

- Popular T-1 3/4 round package.
- Choice of various viewing angles.
- Available on tape and reel.
- Reliable and robust.
- The product itself will remain within RoHS compliant version.
- UV resistant epoxy

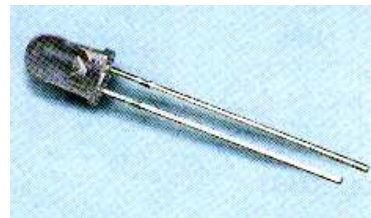

#### Descriptions

- The series is specially designed for applications requiring higher brightness.
- The LED lamps are available with different colors, intensities, epoxy colors, etc.

#### Applications

- Color Graphic Signs
- Message boards
- Variable message signs (VMS)
- Commercial outdoor advertising

#### Device Selection Guide

Chip		Lens Color	Stopper
Material	Emitted Color		
AlGaInP	Brilliant Yellow	Water Clear	Yes

# Technical Data Sheet

## 7343/Y7C2-AQSB/P/MS

### Package Dimensions

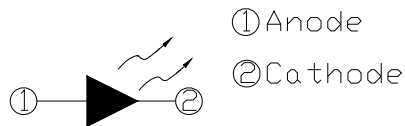
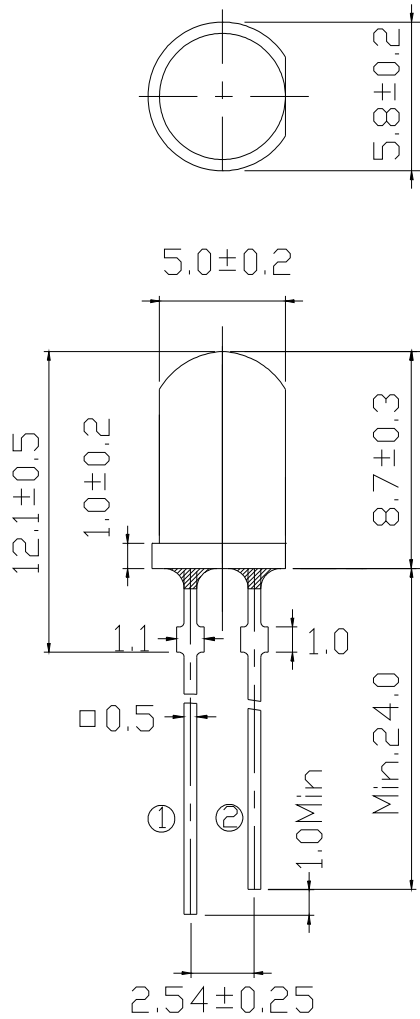

#### Notes:

- All dimensions are in millimeters, tolerance is 0.25mm except being specified.
- Protruded resin under flange is 1.5mm Max LED.



LIGHTING FOREVER

# Technical Data Sheet

## 7343/Y7C2-AQSB/P/MS

### Absolute Maximum Ratings (Ta=25°C)

Parameter	Symbol	Rating	Units
Forward Current	I <sub>F</sub>	50	mA
Pulse Forward Current <sup>*1</sup>	I <sub>FP</sub>	160	mA
Operating Temperature	T <sub>opr</sub>	-40 ~ +85	°C
Storage Temperature	T <sub>stg</sub>	-40 ~ +100	°C
Electrostatic Discharge	ESD	2K	V
Soldering Temperature <sup>*2</sup>	T <sub>sol</sub>	260	°C
Power Dissipation	P <sub>d</sub>	120	mW
Reverse Voltage	V <sub>R</sub>	5	V

**Notes:** \*1:I<sub>FP</sub> Conditions--Pulse Width ≤ 10msec and Duty ≤ 1/10.

\*2:Soldering time ≤ 5 seconds.

### Electro-Optical Characteristics (Ta=25°C)

Parameter	Symbol	Condition	Min.	Typ.	Max.	Units
Forward Voltage	V <sub>F</sub>	I <sub>F</sub> =20mA	1.8	2.0	2.6	V
Luminous Intensity	I <sub>v</sub>	I <sub>F</sub> =20mA	3600	4500	7150	mcd
Viewing Angle	2θ 1/2	I <sub>F</sub> =20mA	--	25	--	deg
Peak Wavelength	λ <sub>p</sub>	I <sub>F</sub> =20mA	--	591	--	nm
Dominant Wavelength	λ <sub>d</sub>	I <sub>F</sub> =20mA	586	589	594	nm
Spectrum Radiation Bandwidth	Δλ	I <sub>F</sub> =20mA	--	15	--	nm
Reverse Current	I <sub>R</sub>	V <sub>R</sub> =5V	--	--	10	μA



LIGHTING FOREVER

## Technical Data Sheet

---

### 7343/Y7C2-AQSB/P/MS

#### Rank Combination ( $I_F=20mA$ )

Rank	Q	R	S
Luminous Intensity	3600~4500	4500~5650	5650~7150

\*Measurement Uncertainty of Luminous Intensity:  $\pm 10\%$

Unit: :mcd

Rank	1	2	3	4
Forward Voltage	1.8~2.0	2.0~2.2	2.2~2.4	2.4~2.6

\*Measurement Uncertainty of Forward Voltage:  $\pm 0.1V$

Unit:V

Rank	1	2
Dominant Wavelength	586~590	590~594

\*Measurement Uncertainty of Dominant Wavelength  $\pm 1.0nm$

Unit:nm

\*The quantity ratio of the ranks is decided by EVERLIGHT.

# Technical Data Sheet

## 7343/Y7C2-AQSB/P/MS

### Typical Electro-Optical Characteristics Curves

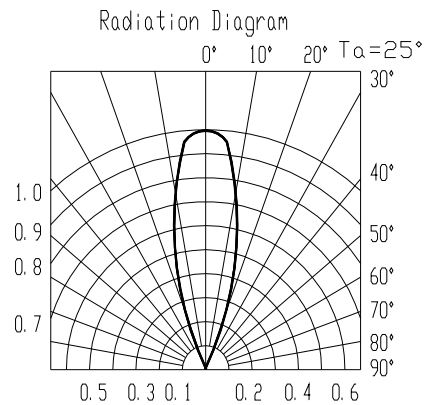
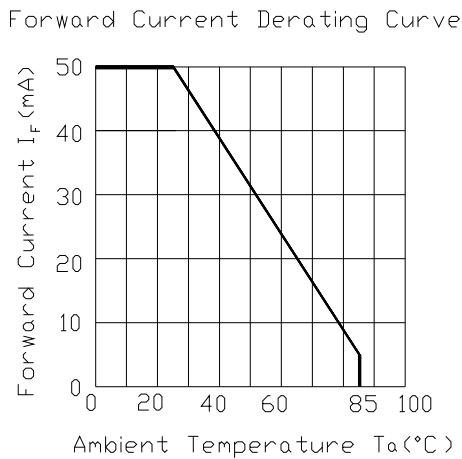
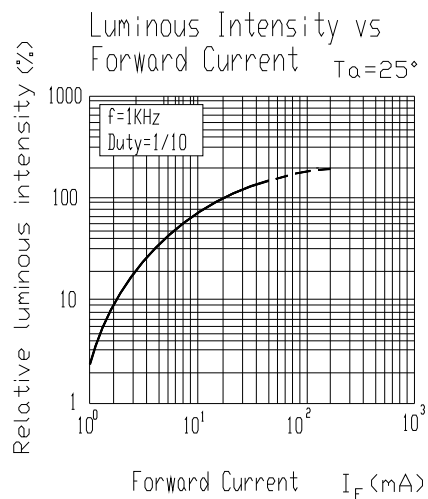
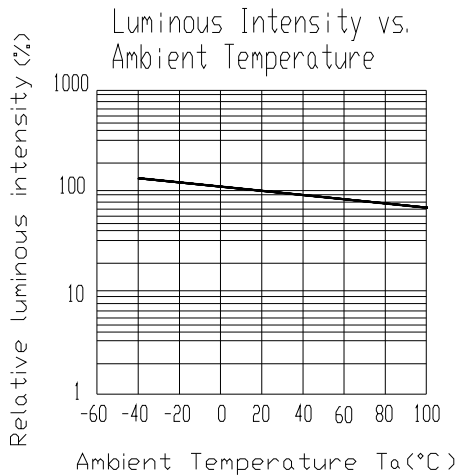
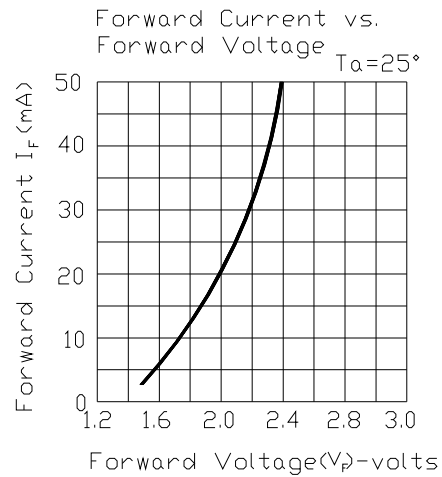
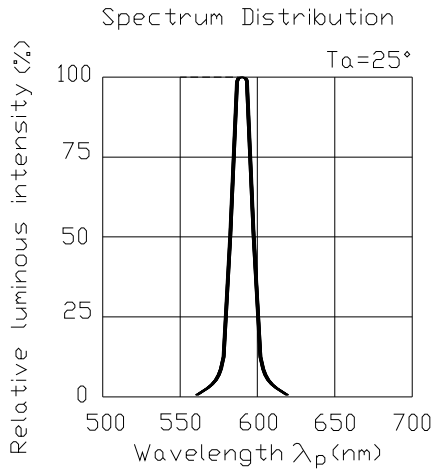

# Technical Data Sheet

## 7343/Y7C2-AQSB/P/MS

### Packing Specification

■ Anti-electrostatic bag

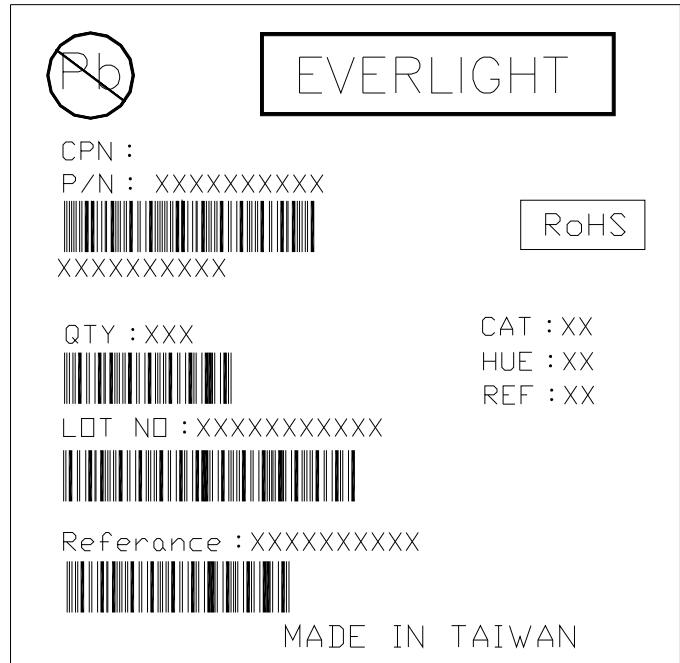
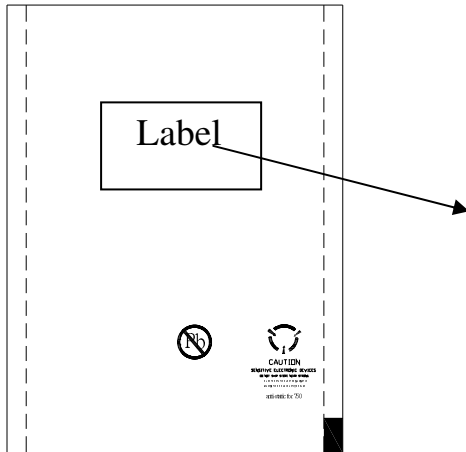

■ Inner Carton

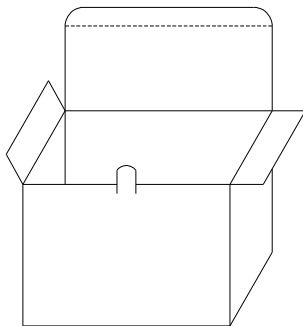

■ Outside Carton

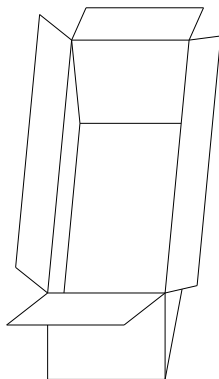

■ Label Form Specification

CPN: Customer's Production Number

P/N : Production Number

QTY: Packing Quantity

CAT: Ranks of Luminous Intensity and Forward Voltage

HUE: Rank of Dominant Wavelength

REF: Reference

LOT No: Lot Number

MADE IN TAIWAN: Production Place

■ Packing Quantity

1. 500 PCS/1 Bag, 5 Bags/1 Inner Carton

2. 10 Inner Cartons/1 Outside Carton

## Technical Data Sheet

---

### 7343/Y7C2-AQSB/P/MS

#### Notes

##### 1. Lead Forming

- During lead formation, the leads should be bent at a point at least 3mm from the base of the epoxy bulb.
- Lead forming should be done before soldering.
- Avoid stressing the LED package during leads forming. The stress to the base may damage the LED's characteristics or it may break the LEDs.
- Cut the LED leadframes at room temperature. Cutting the leadframes at high temperatures may cause failure of the LEDs.
- When mounting the LEDs onto a PCB, the PCB holes must be aligned exactly with the lead position of the LED. If the LEDs are mounted with stress at the leads, it causes deterioration of the epoxy resin and this will degrade the LEDs.

##### 2. Storage

- The LEDs should be stored at 30°C or less and 70%RH or less after being shipped from Everlight and the storage life limits are 3 months. If the LEDs are stored for 3 months or more, they can be stored for a year in a sealed container with a nitrogen atmosphere and moisture absorbent material.
- Please avoid rapid transitions in ambient temperature, especially, in high humidity environments where condensation can occur.

##### 3. Soldering

- Careful attention should be paid during soldering. When soldering, leave more than 3mm from solder joint to epoxy bulb, and soldering beyond the base of the tie bar is recommended.

# Technical Data Sheet

## 7343/Y7C2-AQSB/P/MS

■ Recommended soldering conditions:

Hand Soldering		DIP Soldering	
Temp. at tip of iron	300°C Max. (30W Max.)	Preheat temp.	100°C Max. (60 sec Max.)
Soldering time	3 sec Max.	Bath temp. & time	260 Max., 5 sec Max
Distance	3mm Min.(From solder joint to epoxy bulb)	Distance	3mm Min. (From solder joint to epoxy bulb)

■ Recommended soldering profile

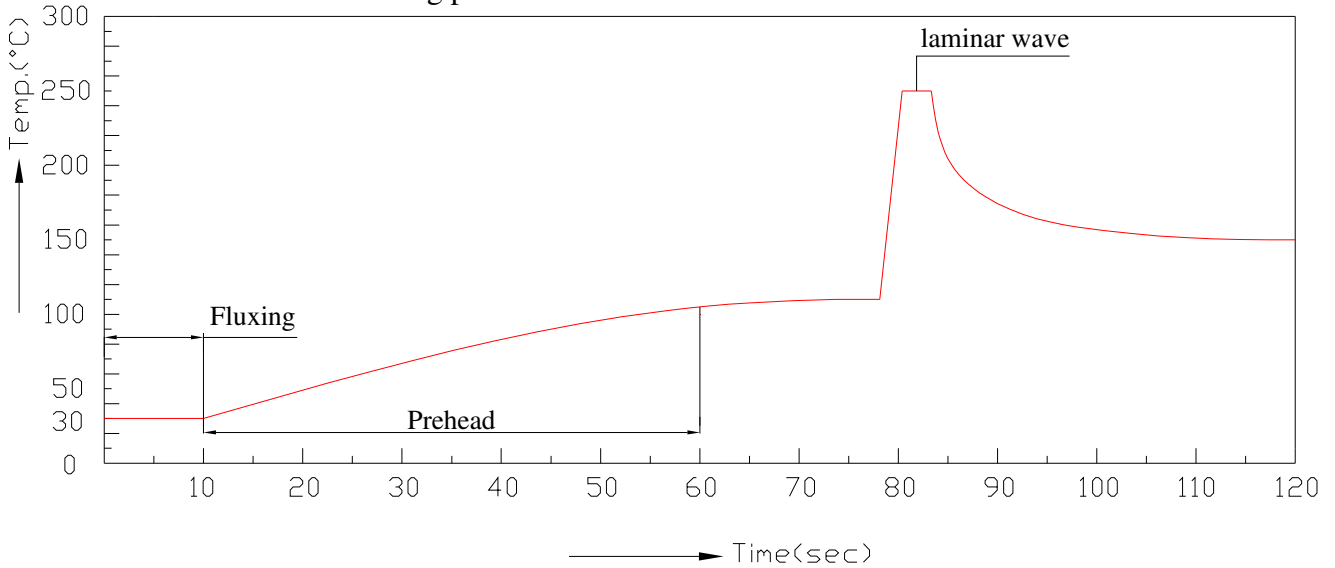

- Avoiding applying any stress to the lead frame while the LEDs are at high temperature particularly when soldering.
- Dip and hand soldering should not be done more than one time
- After soldering the LEDs, the epoxy bulb should be protected from mechanical shock or vibration until the LEDs return to room temperature.
- A rapid-rate process is not recommended for cooling the LEDs down from the peak temperature.
- Although the recommended soldering conditions are specified in the above table, dip or



## Technical Data Sheet

---

### 7343/Y7C2-AQSB/P/MS

handsoldering at the lowest possible temperature is desirable for the LEDs.

- Wave soldering parameter must be set and maintain according to recommended temperature and dwell time in the solder wave.

#### 4. Cleaning

- When necessary, cleaning should occur only with isopropyl alcohol at room temperature for a duration of no more than one minute. Dry at room temperature before use.
- Do not clean the LEDs by the ultrasonic. When it is absolutely necessary, the influence of ultrasonic cleaning on the LEDs depends on factors such as ultrasonic power and the assembled condition. Ultrasonic cleaning shall be pre-qualified to ensure this will not cause damage to the LED

#### 5. Heat Management

- Heat management of LEDs must be taken into consideration during the design stage of LED application. The current should be de-rated appropriately by referring to the de-rating curve found in each product specification.
- The temperature surrounding the LED in the application should be controlled. Please refer to the data sheet de-rating curve.

#### 6. ESD (Electrostatic Discharge)

- Electrostatic discharge (ESD) or surge current (EOS) can damage LEDs.
- An ESD wrist strap, ESD shoe strap or antistatic gloves must be worn whenever handling LEDs.
- All devices, equipment and machinery must be properly grounded.
- Use ion blower to neutralize the static charge which might have built up on surface of the LEDs plastic lens as a result of friction between LEDs during storage and handing.

#### 7. Other

- Above specification may be changed without notice. EVERLIGHT will reserve authority on material change for above specification.



LIGHTING FOREVER

## Technical Data Sheet

---

### 7343/Y7C2-AQSB/P/MS

- When using this product, please observe the absolute maximum ratings and the instructions for using outlined in these specification sheets. EVERLIGHT assumes no responsibility for any damage resulting from use of the product which does not comply with the absolute maximum ratings and the instructions included in these specification sheets.
- These specification sheets include materials protected under copyright of EVERLIGHT corporation. Please don't reproduce or cause anyone to reproduce them without EVERLIGHT's consent.

**EVERLIGHT ELECTRONICS CO., LTD.**  
Office: No 25, Lane 76, Sec 3, Chung Yang Rd,  
Tucheng, Taipei 236, Taiwan, R.O.C

Tel: 886-2-2267-2000, 2267-9936  
Fax: 886-2267-6244, 2267-6189, 2267-6306  
<http://www.everlight.com>

## X-ON Electronics

Largest Supplier of Electrical and Electronic Components

*Click to view similar products for [Standard LEDs - Through Hole category:](#)*

*Click to view products by [Everlight manufacturer:](#)*

Other Similar products are found below :

[LTL-10254W](#) [LTL-1214A](#) [LTL-2231AT](#) [LTL-3251A](#) [LTL-4262N](#) [LTL-433P](#) [LTL-5234](#) [LTL87HTBK](#) [LTX-87HD4B](#) [HLMP-EL30-PS0DD](#) [1L0532V23G0TD001](#) [NSPW500CS](#) [LD CQDP-1U3U-W5-1-K](#) [LP379PPG1C0G0300001](#) [SLR-342MC3F](#) [SLX-LX3044GD](#) [SLX-LX3044ID](#) [SLX-LX3044YD](#) [1.90690.3330000](#) [SSS-LX4673ID-410B](#) [1L0532Y24I0TD001](#) [264-7SYGD/S530-E2](#) [HLMP-1301-G00FG](#) [HLMP1385](#) [LTL-10224W](#) [LTL-1224A](#) [LTL-1234A](#) [LTL-2251AT](#) [LTL-403HR](#) [LTL-4222](#) [LU7-E-B](#) [4380H1](#) [HLMP-3962-F0002](#) [HLMP-GG15-R0000](#) [323-2SURD/S530-A3](#) [L53SRC/E-Z](#) [L-7679C1ZGC](#) [4302T1-5V](#) [4306D23](#) [4363D1/5](#) [WP1503SRC/J4](#) [WP153YDT](#) [WP1543SGC](#) [WP1543SURC](#) [WP53MGD](#) [WP7113HD](#) [WP7113MBD](#) [WP7113MGC](#) [WP7143SEC/H](#) [Z-221A](#)