

Technical Data Sheet

Side View LEDs (Height 0.8mm)

99-213UMC/4042770/TR8

Features

- Side view white LED.
- White SMT package.
- Lead frame package with individual 2 pins.
- Wide viewing angle.
- Soldering methods: IR reflow soldering.
- Pb-free.
- The product itself will remain within RoHS compliant version.

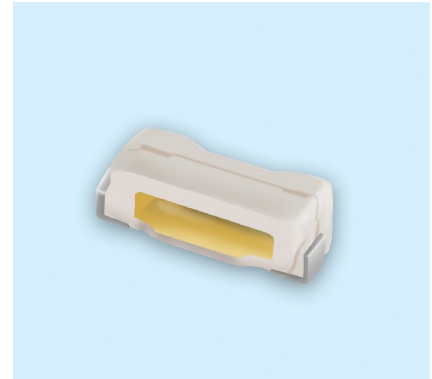

Descriptions

- Due to the package design, 99-213 has wide viewing angle , low power consumption and white LEDs are devices which are materialized by combing Blue LEDs and special phosphors . This feature makes the LED ideal for light guide application.

Applications

- LCD back light.
- Mobile phones .
- Indicators.
- Illuminations.
- Switch lights.

Device Selection Guide

Chip	Emitted Color	Resin Color
Material		
InGaN	White	Water Clear

Technical Data Sheet

Side View LEDs (Height 0.8mm)

99-213UMC/4042770/TR8

Package Outline Dimensions

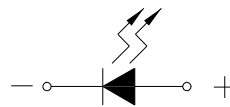
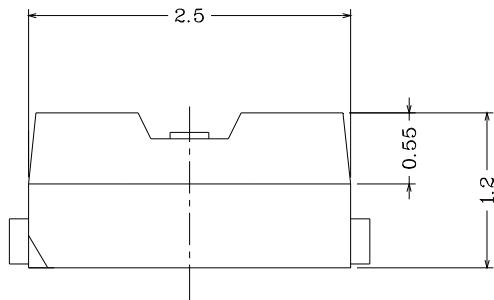

Polarity

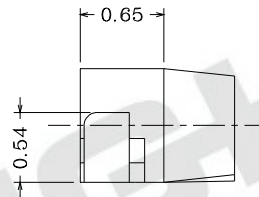
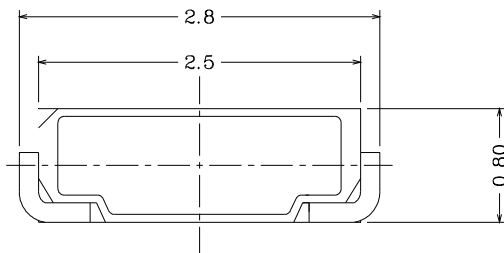

Recommended soldering pad design

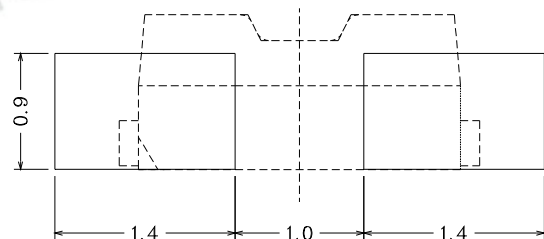
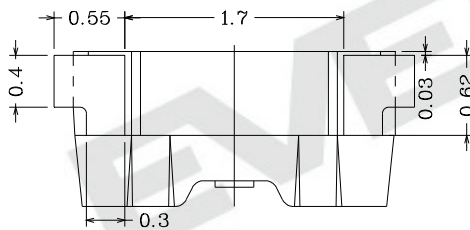

Note: The tolerances unless mentioned is $\pm 0.1\text{mm}$, Unit = mm

Technical Data Sheet

Side View LEDs (Height 0.8mm)

99-213UMC/4042770/TR8

Absolute Maximum Ratings (Ta=25)

Parameter	Symbol	Rating	Unit
Reverse Voltage	V _R	5	V
Forward Current	I _F	30	mA
Peak Forward Current (Duty 1/10 @10ms)	I _{FP}	100	mA
Power Dissipation	P _d	110	mW
Electrostatic Discharge(HBM)* ¹	ESD	2000	V
Operating Temperature	T _{opr}	-40 ~ +85	
Storage Temperature	T _{stg}	-40 ~ +90	
Soldering Temperature	T _{sol}	Reflow Soldering : 260 for 10 sec. Hand Soldering : 350 for 3 sec.	

Note: 1. The products are sensitive to static electricity and must be carefully taken when handling products.

Electro-Optical Characteristics (Ta=25)

Parameter	Symbol	Min.	Typ.	Max.	Unit	Condition
Luminous Intensity	I _v	2100	-----	2300	mcd	I _F =20mA
Viewing Angle	2θ _{1/2}	-----	110	-----	deg	I _F =20mA
Forward Voltage	V _F	2.95	-----	3.55	V	I _F =20mA
Reverse Current	I _R	-----	-----	50	μA	V _R =5V

Notes:

1. Tolerance of Luminous Intensity: ±7%
2. Tolerance of Forward Voltage: ±0.05V

Technical Data Sheet

Side View LEDs (Height 0.8mm)

99-213UMC/4042770/TR8

Bin Range of Luminous Intensity

Bin Code	Min.	Max.	Unit	Condition
40	2100	2150	mcd	I _F =20mA
41	2150	2200		
42	2200	2300		

Note: Tolerance of Luminous Intensity: $\pm 7\%$

Bin Range of Forward Voltage

Bin Code	Min.	Max.	Unit	Condition
6-1	2.95	3.05	V	I _F =20mA
6-2	3.05	3.15		
7-1	3.15	3.25		
7-2	3.25	3.35		
8-1	3.35	3.45		
8-2	3.45	3.55		

Note: Tolerance of Forward Voltage : $\pm 0.05V$

Technical Data Sheet

Side View LEDs (Height 0.8mm)

99-213UMC/4042770/TR8

Chromaticity Coordinates Specifications for Bin Grading

Bin Code	CIE_x	CIE_y	Bin Code	CIE_x	CIE_y
B5-3-1	0.2938	0.2808	B5-4-1	0.3019	0.2900
	0.2917	0.2857		0.3003	0.2950
	0.2959	0.2903		0.3046	0.2998
	0.2978	0.2854		0.3059	0.2946
B5-3-2	0.2978	0.2854	B5-4-2	0.3059	0.2946
	0.2959	0.2903		0.3046	0.2998
	0.3003	0.2950		0.3090	0.3045
	0.3019	0.2900		0.3100	0.2993
B5-3-3	0.2960	0.2760	B5-4-3	0.3035	0.2850
	0.2938	0.2808		0.3019	0.2900
	0.2978	0.2854		0.3059	0.2946
	0.2998	0.2805		0.3073	0.2895
B5-3-4	0.2998	0.2805	B5-4-4	0.3073	0.2895
	0.2978	0.2854		0.3059	0.2946
	0.3019	0.2900		0.3100	0.2993
	0.3035	0.2850		0.3110	0.2940

Note: Tolerance of Chromaticity Coordinates: ± 0.01

Technical Data Sheet Side View LEDs (Height 0.8mm)

99-213UMC/4042770/TR8

The C.I.E. 1931 Chromaticity Diagram

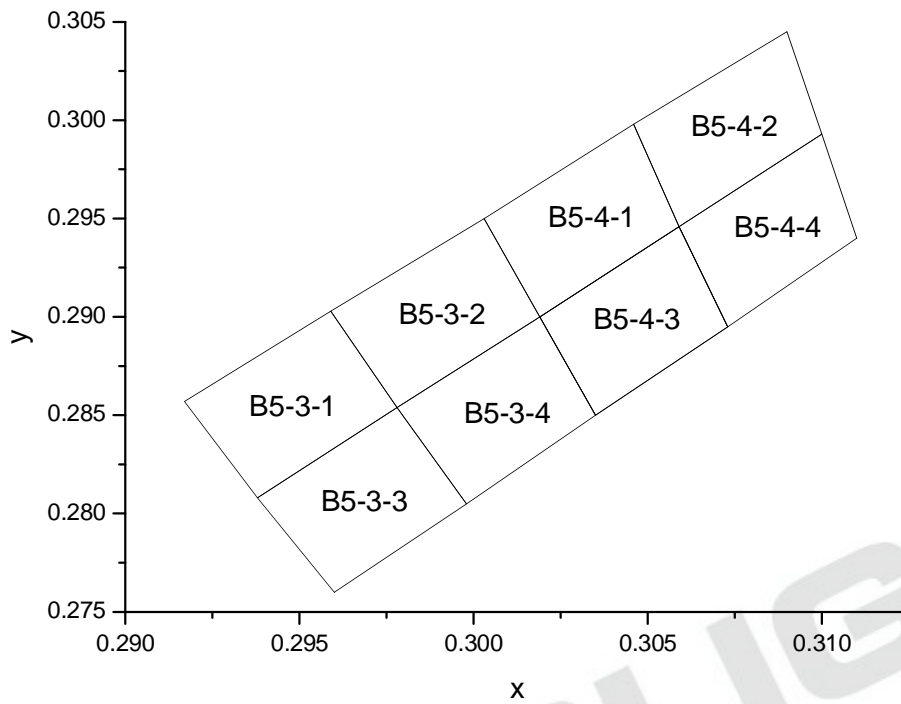

Technical Data Sheet
Side View LEDs (Height 0.8mm)

99-213UMC/4042770/TR8

Typical Electro-Optical Characteristics Curves

1. Spectrum Distribution
 (T_S=25 °C, I_F=20mA)

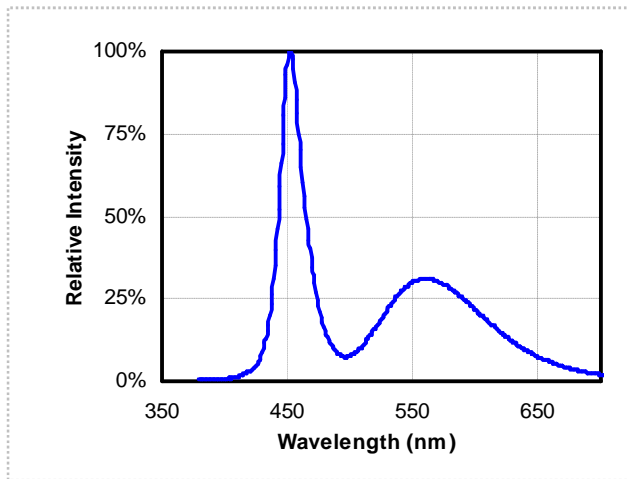

2. Relative Luminous Flux vs. Forward Current
 (T_S=25 °C)

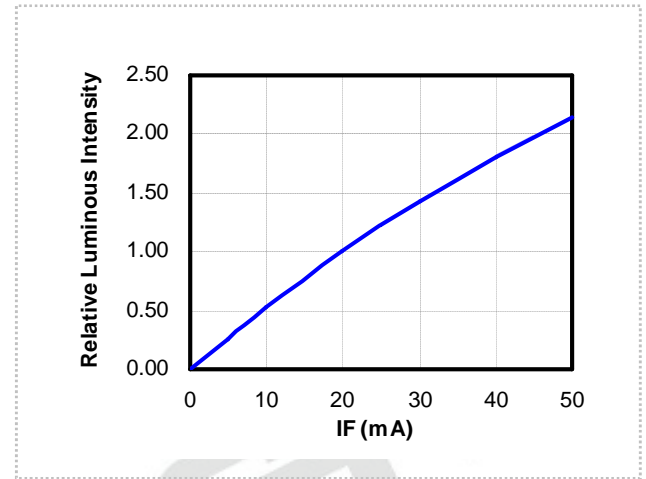

3. Relative Forward Voltage vs. Forward Current
 (T_S=25 °C)

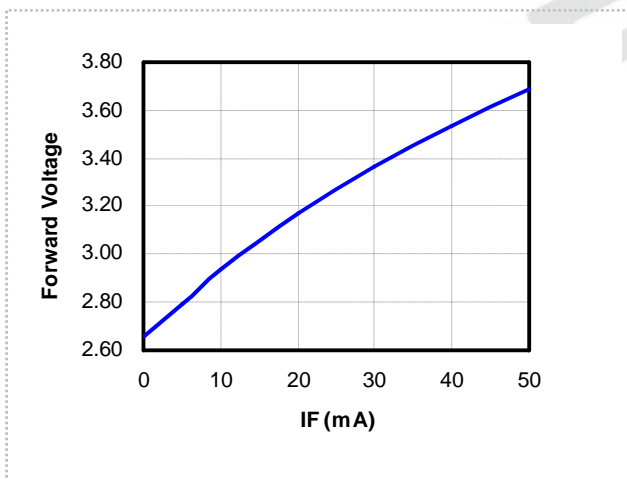

4. Radiation Diagram
 (T_S=25 °C, I_F=20mA)

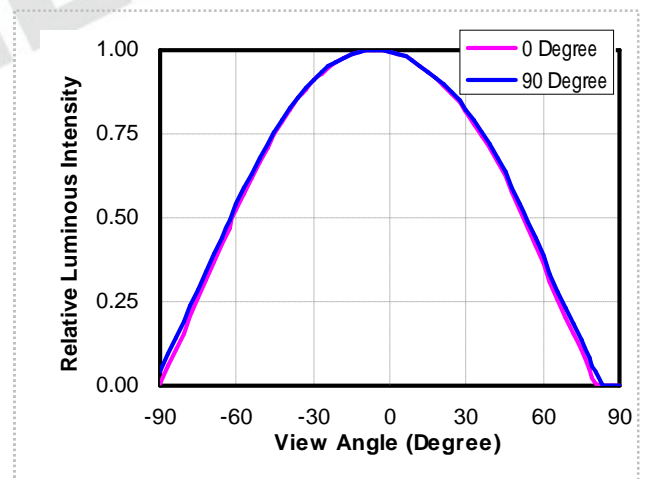

Technical Data Sheet

Side View LEDs (Height 0.8mm)

99-213UMC/4042770/TR8

Typical Electro-Optical-Thermal Characteristics Curves

5. Relative Luminous Flux vs. Solder Temperature
($I_F=20\text{mA}$)

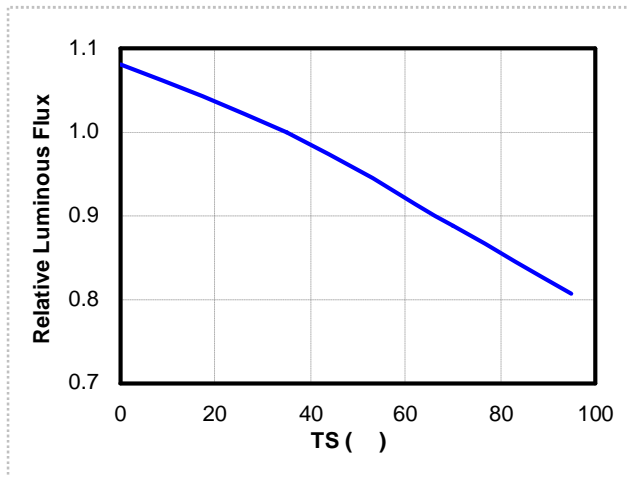

6. Forward Voltage vs. Solder Temperature
($I_F=20\text{mA}$)

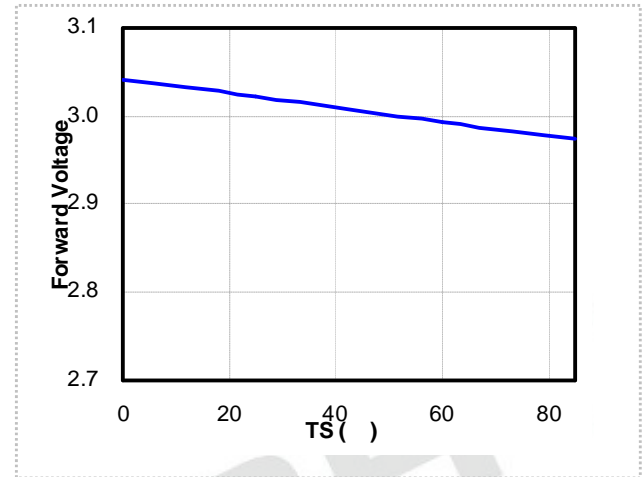

7. Chromaticity Coordinates vs. Solder Temperature
($I_F=20\text{mA}$)

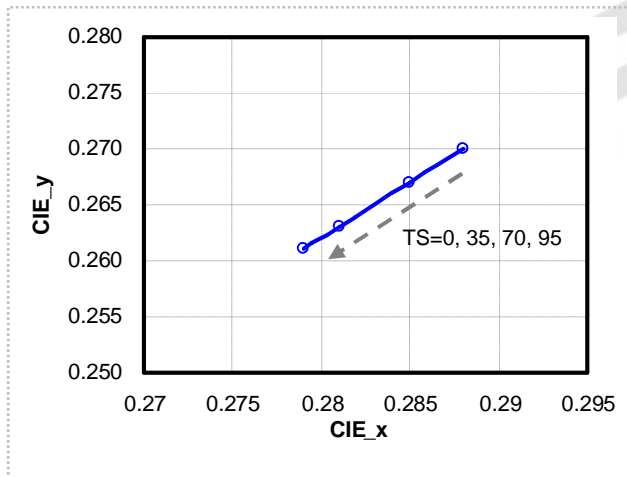

8. Forward Current De-rating Curve

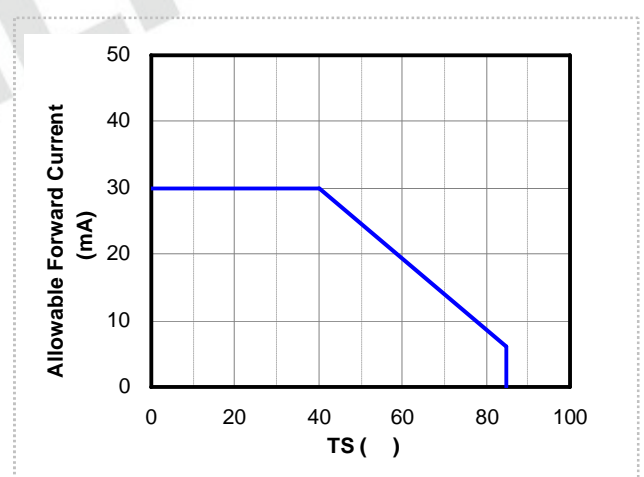

Technical Data Sheet

Side View LEDs (Height 0.8mm)

99-213UMC/4042770/TR8

Label Explanation

CAT: Luminous Intensity Rank
 HUE: Chromaticity Coordinates
 REF: Forward Voltage Rank

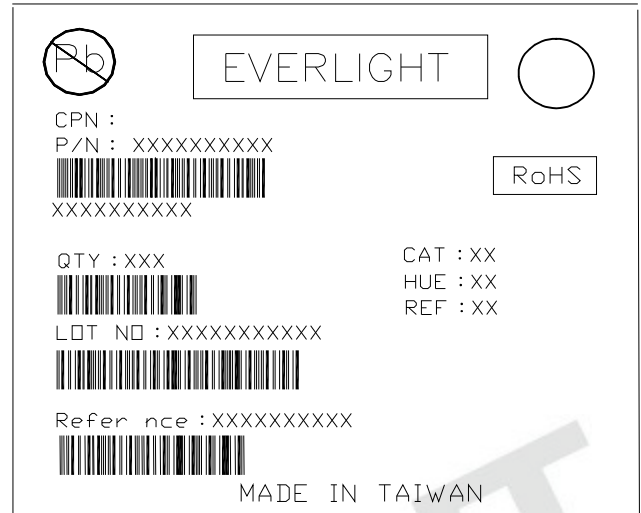

Reel Dimensions

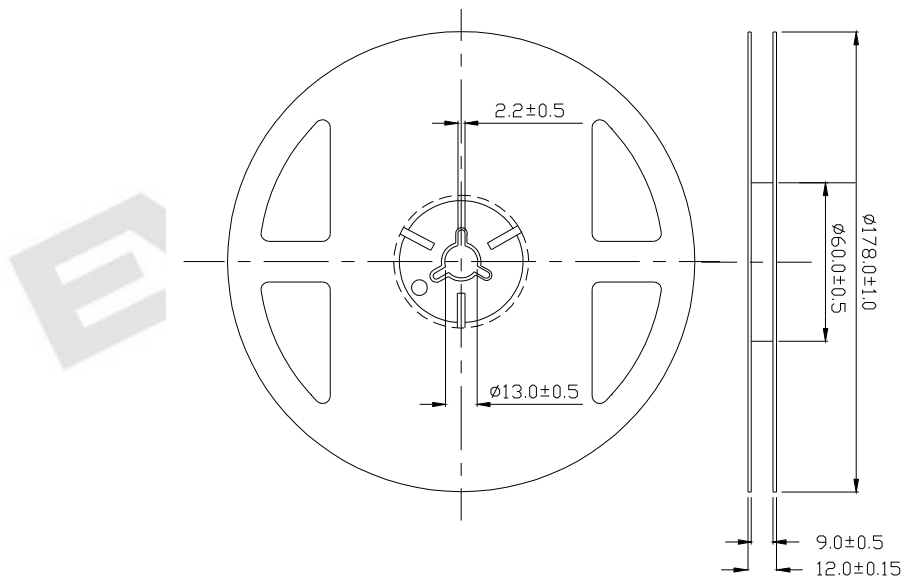

Note: The tolerances unless mentioned is ± 0.1 mm, Unit = mm

Technical Data Sheet

Side View LEDs (Height 0.8mm)

99-213UMC/4042770/TR8

Carrier Tape Dimensions: Loaded Quantity 250/500/1000/2000 pcs Per Reel

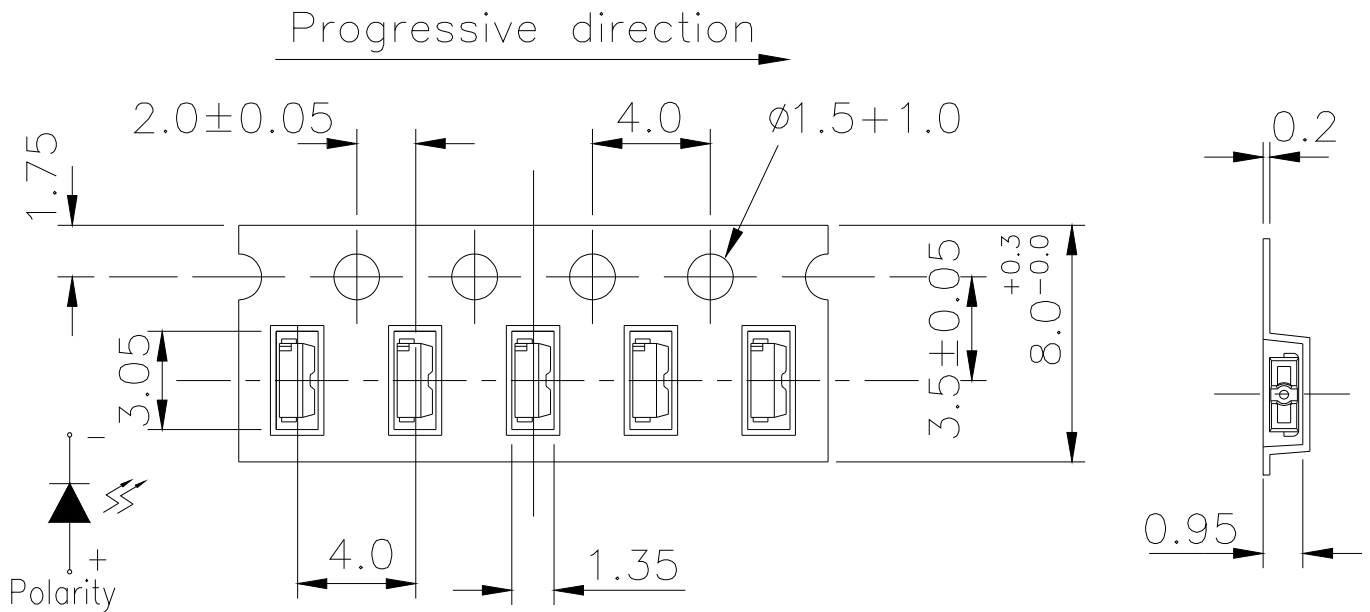

Note: The tolerances unless mentioned is ±0.1mm, Unit = mm

Moisture Resistant Packaging

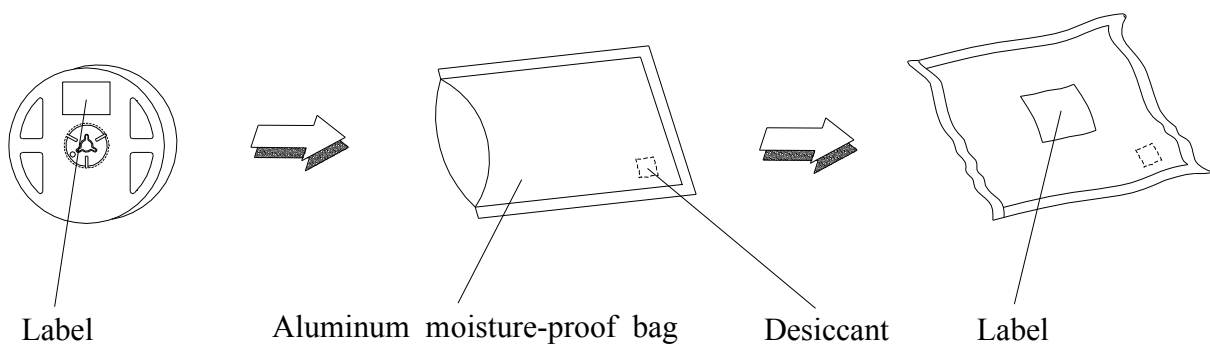

Technical Data Sheet

Side View LEDs (Height 0.8mm)

99-213UMC/4042770/TR8

Reliability Test Items and Conditions

The reliability of products shall be satisfied with items listed below.

Confidence level : 90%

LTPD : 10%

NO	Item	Test Condition		Test Hours / Times	Criteria	
		Temp./ Humidity	I _F (mA)		I _v @ 20mA	V _F @ 20mA
1	Reflow Soldering	TSld = 260 , Max. 10sec.		2 times	<±10%	<±10%
2	Thermal Cycle	-40 ~ 100 30min. (5min.) 30min.		200 cycles	I _v > 70%, V _F < 110%,	
3	Thermal Shock	-10 ~ 100 20min. (<15sec.) 20min.		200 cycles		
4	Low Temp. Storage	Ta= -40	--	1000 hrs		
5	High Temp. Storage	Ta= 100	--	1000 hrs		
6	Temp. Humidity Storage	Ta= 60 / 90%RH	--	1000 hrs		
7	Steady State Operating Life of Low Temp.	Ta= -40	20	1000 hrs		
8	Steady State Operating Life Condition 1	Ta= 25 / Room Humidity	20	1000 hrs		
9	Steady State Operating Life Condition 2	Ta= 60	20	1000 hrs		
10	Steady State Operating Life of High Temp.	Ta= 85	5	1000 hrs		
11	Steady State Operating Life of High Humidity Heat	Ta= 60 / 90%RH	20	1000 hrs		

Technical Data Sheet

Side View LEDs (Height 0.8mm)

99-213UMC/4042770/TR8

Precautions For Use

1. Over-current-proof

Customer must apply resistors for protection, otherwise slight voltage shift will cause big current change (Burn out will happen).

2. Storage

2.1 Do not open moisture proof bag before the products are ready to use.

2.2 Before opening the package: The LEDs should be kept at 30 °C or less and 90%RH or less.

2.3 After opening the package: The LED's floor life is 1 year under 30 °C or less and 60% RH or less. If unused LEDs remain, it should be stored in moisture proof packages.

2.4 If the moisture absorbent material (silica gel) has faded away or the LEDs have exceeded the storage time, baking treatment should be performed using the following conditions.

Baking treatment : 60±5 °C for 24 hours.

3. Soldering Condition

3.1 Pb-free solder temperature profile

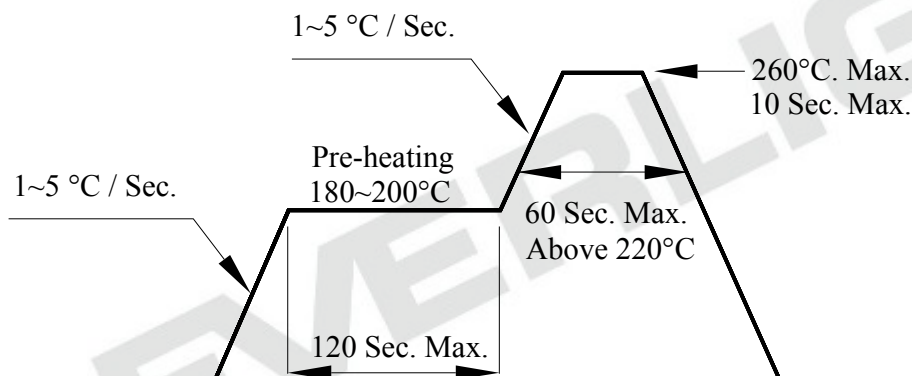

3.2 Reflow soldering should not be done more than two times.

3.3 When soldering, do not put stress on the LEDs during heating.

3.4 After soldering, do not warp the circuit board.

4. Soldering Iron

Each terminal is to go to the tip of soldering iron temperature less than 350 °C for 3 seconds within once in less than the soldering iron capacity 25W. Leave two seconds and more intervals, and do soldering of each terminal. Be careful because the damage of the product is often started at the time of the hand solder.

5. Repairing

Technical Data Sheet

Side View LEDs (Height 0.8mm)

99-213UMC/4042770/TR8

Repair should not be done after the LEDs have been soldered. When repairing is unavoidable, a double-head soldering iron should be used (as below figure). It should be confirmed beforehand whether the characteristics of the LEDs will or will not be damaged by repairing.

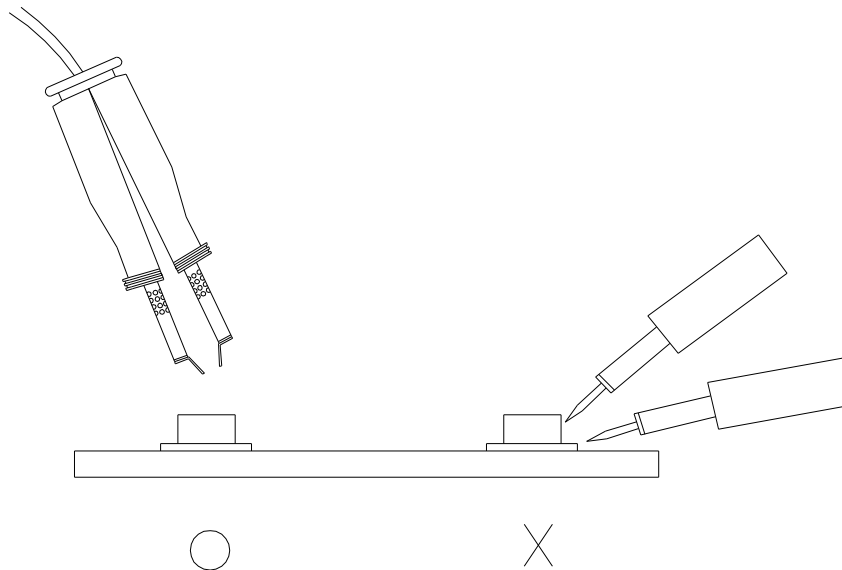

6. Handling Indications

During processing, mechanical stress on the surface should be minimized as much as possible. Sharp objects of all types should not be used to pierce the sealing compound

EVERLIGHT ELECTRONICS CO., LTD.
Office: No.6-8, Zhonghua Rd.
Shulin Dist., New Taipei City, Taiwan, R.O.C.

Tel: +886-2 2685-6688
Fax: +886-2 2685-6898
<http://www.everlight.com>

X-ON Electronics

Largest Supplier of Electrical and Electronic Components

Click to view similar products for [Standard LEDs - SMD category](#):

Click to view products by [Everlight manufacturer](#):

Other Similar products are found below :

[LTST-C190KYKT](#) [LTST-C19GD2WT](#) [LTST-N683GBEW](#) [LTW-170ZDC](#) [LTW-M140SZS40](#) [LTW-M140ZVS](#) [598-8110-100F](#) [91-21SUBCS400-A6TR7](#) [AAAF5060QBFSEEZGS](#) [HLMA-QG00-S0021](#) [HLMP-6305-L0011](#) [APT1608QGW](#) [99-213/R6C-AR2T1B/2C](#) [SML-LX0606SISUGC/A](#) [SML-LXR851SIUPGUBC](#) [LT1ED53A](#) [AM27ZGC03](#) [APFA3010SURKCGKQBDC](#) [APHK1608VGCA](#) [APT2012QGW](#) [LTST-008BGEW](#) [LTW-010DCG](#) [LTW-020ZDCG](#) [LTW-21TS5](#) [LTW-220DS5](#) [LO T67F-V1AB-24-1](#) [598-8330-117F](#) [CMDA20AYAA7D1S](#) [95-21SURCS530-A3TR10](#) [HSMQ-C177](#) [598-8040-100F](#) [598-8070-100F](#) [598-8140-100F](#) [598-8610-200F](#) [SML-LXL1209SYC/ATR](#) [CMD91-21VRC/TR7](#) [SML-512PWT86A](#) [SMF-2432GYC-TR](#) [EASV3015RGYA0](#) [LTST-C190KFKT-5A](#) [LTST-C194TBKT-5A](#) [CLX6E-FKC-CH1M1D1BB7C3D3](#) [SML-LXL0805USBC-TR](#) [SML-LX2835SYSUGCTR](#) [LTW-M670ZVS-M5](#) [APA2106ZGC/G](#) [CLMXB-FKA-CbcfghjnpACBB79463](#) [VFA1101W-5AY3B2-TR](#) [LCB P473-P2R2-3J7L-1-Z](#) [HSMR-C197](#)