

## SMD ■ REFLECTOR

### 99-235/RSGHB7C-M03/2D



#### Features

- White package.
- Optical indicator.
- Colorless clear window.
- Ideal for backlight and light pipe application.
- Inter reflector.
- Wide viewing angle.
- Suitable for vapor-phase reflow, Infrared reflow and wave solder processes.
- Computable with automatic placement equipment.
- Available on tape and reel (12mm Tape)
- Pb-free
- The product itself will remain within RoHS compliant version.

#### Applications

- Telecommunication: indicator and backlighting in telephone and fax.
- Flat backlight for LCD's, switches and symbols.
- Light pipe application.
- General use.

## Device Selection Guide

Chip Materials		Emitted Color	Resin Color
RS	AlGaInP	Brilliant Red	Water Clear
GH	InGaN	Brilliant Green	
B7	InGaN	Blue	

## Absolute Maximum Ratings (Ta=25°C)

Parameter	Symbol	Rating	Unit
Reverse Voltage	VR	5	V
Forward Current	IF	RS	50
		GH	30
		B7	30
Peak Forward Current(Duty 1/10@ 1KHZ)	IFP	RS	100
		GH	100
		B7	100
Power Dissipation	Pd	RS	130
		GH	110
		B7	110
Electrostatic Discharge(HBM)	ESD	RS	2000
		GH	1000
		B7	1000
Operating Temperature	Topr	-40 ~ +85	°C
Storage Temperature	Tstg	-40~ +90	°C
Soldering Temperature	Tsol	Reflow Soldering : 260 °C for 10 sec. Hand Soldering : 350 °C for 3 sec.	

Electro-Optical Characteristics (Ta=25°C)

Parameter	Symbol	Min.	Typ.	Max.	Unit	Condition
Luminous Intensity	IV	900	-----	2240	mcd	
Viewing Angle	2θ1/2	-----	120	-----	deg	
Peak Wavelength	λp	RS	-----	632	-----	nm
		GH	-----	518	-----	
		B7	-----	468	-----	
Dominant Wavelength	λd	RS	618	-----	629	nm
		GH	515	-----	535	
		B7	460	-----	475	
Spectrum Radiation Bandwidth	Δλ	RS	-----	20	-----	nm
		GH	-----	36	-----	
		B7	-----	26	-----	
Forward Voltage	VF	RS	1.6	--	2.4	V
		GH	2.5	--	3.5	
		B7	2.5	--	3.5	
Reverse Current	IR	RS	-----	-----	10	μA
		GH	-----	-----	50	
		B7	-----	-----	50	

Note:

1. Tolerance of Luminous Intensity: ±11%
2. Tolerance of Dominant Wavelength: ±1nm
3. Tolerance of Forward Voltage: ±0.1V

### Bin Range of Luminous Intensity

Bin Code	Min.	Max.	Unit	Condition
V2	900	1120	mcd	IF=11mA(R)
W1	1120	1420		IF=16mA(G)
W2	1420	1800		IF=10mA(B)
X1	1800	2240		

Note:  
Tolerance of Luminous Intensity:  $\pm 11\%$

EVERLIGHT

**Bin Code of Chromaticity Coordinates**  
**R/G/B=11/16/10mA**

Bin Code	CIE_x	CIE_y	Bin Code	CIE_x	CIE_y
S01	0.20	0.24	S02	0.22	0.24
	0.20	0.28		0.22	0.28
	0.22	0.28		0.24	0.28
	0.22	0.24		0.24	0.24
S03	0.24	0.24	S04	0.26	0.24
	0.24	0.28		0.26	0.28
	0.26	0.28		0.28	0.28
	0.26	0.24		0.28	0.24
S05	0.28	0.24	S06	0.30	0.24
	0.28	0.28		0.30	0.28
	0.30	0.28		0.32	0.28
	0.30	0.24		0.32	0.24
S07	0.32	0.24	S08	0.34	0.24
	0.32	0.28		0.34	0.28
	0.34	0.28		0.36	0.28
	0.34	0.24		0.36	0.24
S09	0.20	0.28	S10	0.22	0.28
	0.20	0.32		0.22	0.32
	0.22	0.32		0.24	0.32
	0.22	0.28		0.24	0.28
S11	0.24	0.28	S12	0.26	0.28
	0.24	0.32		0.26	0.32
	0.26	0.32		0.28	0.32
	0.26	0.24		0.28	0.28
S13	0.28	0.28	S14	0.30	0.28
	0.28	0.32		0.30	0.32
	0.30	0.32		0.32	0.32
	0.30	0.28		0.32	0.28
S15	0.32	0.28	S16	0.34	0.28
	0.32	0.32		0.34	0.32
	0.34	0.32		0.36	0.32
	0.34	0.28		0.36	0.28

Bin Code	CIE_x	CIE_y	Bin Code	CIE_x	CIE_y
S17	0.20	0.32	S18	0.22	0.32
	0.20	0.36		0.22	0.36
	0.22	0.36		0.24	0.36
	0.22	0.32		0.24	0.32
S19	0.24	0.32	S20	0.26	0.32
	0.24	0.36		0.26	0.36
	0.26	0.36		0.28	0.36
	0.26	0.32		0.28	0.32
S21	0.28	0.32	S22	0.30	0.32
	0.28	0.36		0.30	0.36
	0.30	0.36		0.32	0.36
	0.30	0.32		0.32	0.32
S23	0.32	0.32	S24	0.34	0.32
	0.32	0.36		0.34	0.36
	0.34	0.36		0.36	0.36
	0.34	0.32		0.36	0.32
S25	0.20	0.36	S26	0.22	0.36
	0.20	0.40		0.22	0.40
	0.22	0.40		0.24	0.40
	0.22	0.36		0.24	0.36
S27	0.24	0.36	S28	0.26	0.36
	0.24	0.40		0.26	0.40
	0.26	0.40		0.28	0.40
	0.26	0.36		0.28	0.36
S29	0.28	0.36	S30	0.30	0.36
	0.28	0.40		0.30	0.40
	0.30	0.40		0.32	0.40
	0.30	0.36		0.32	0.36
S31	0.32	0.36	S32	0.34	0.36
	0.32	0.40		0.34	0.40
	0.34	0.40		0.36	0.40
	0.34	0.36		0.36	0.36

Bin Code	CIE_x	CIE_y	Bin Code	CIE_x	CIE_y
S33	0.20	0.40	S34	0.22	0.40
	0.20	0.44		0.22	0.44
	0.22	0.44		0.24	0.44
	0.22	0.40		0.24	0.40
S35	0.24	0.40	S36	0.26	0.40
	0.24	0.44		0.26	0.44
	0.26	0.44		0.28	0.44
	0.26	0.40		0.28	0.40
S37	0.28	0.40	S38	0.30	0.40
	0.28	0.44		0.30	0.44
	0.30	0.44		0.32	0.44
	0.30	0.40		0.32	0.40
S39	0.32	0.40	S40	0.34	0.40
	0.32	0.44		0.34	0.44
	0.34	0.44		0.36	0.44
	0.34	0.40		0.36	0.40

Note:  
Tolerance of Chromaticity Coordinates:  $\pm 0.01$ .

### CIE diagram

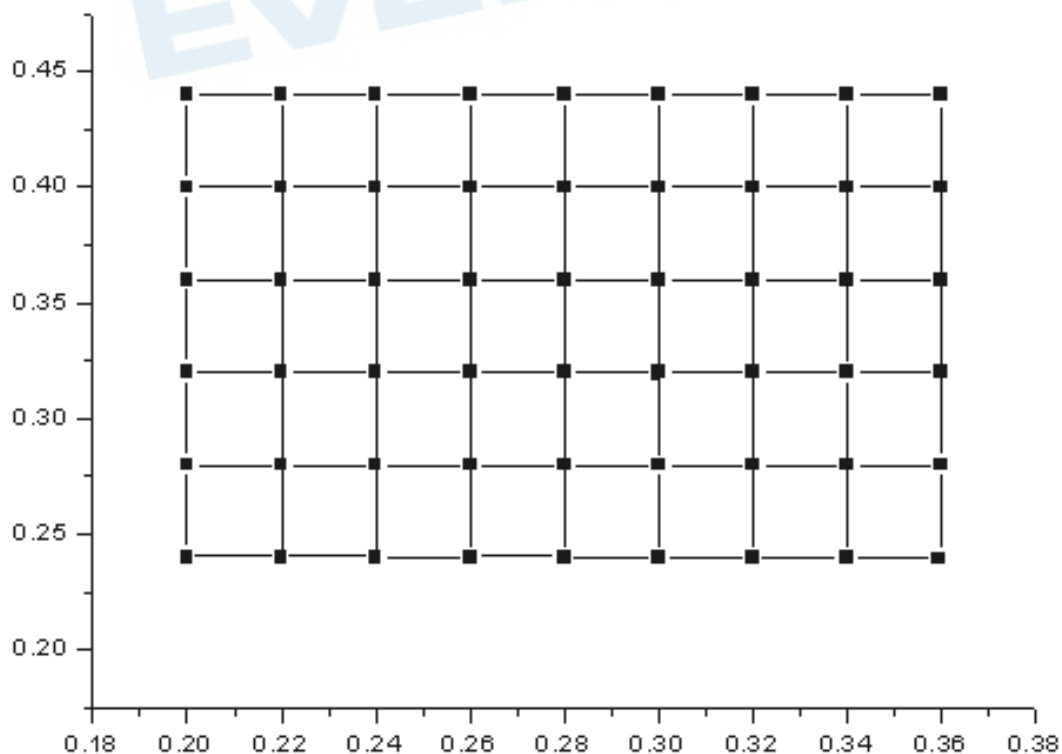

Typical Electro-Optical Characteristics Curves(RS)

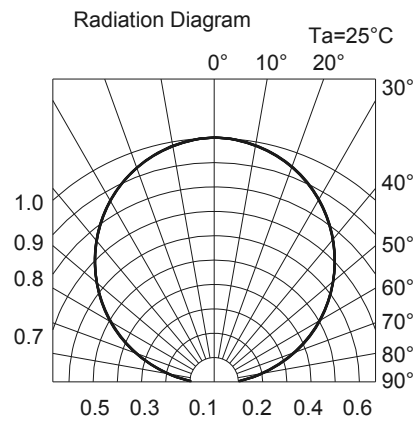
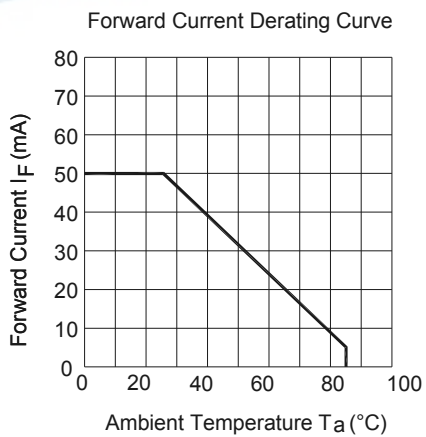
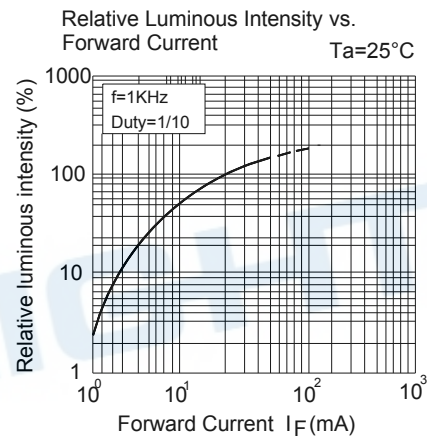
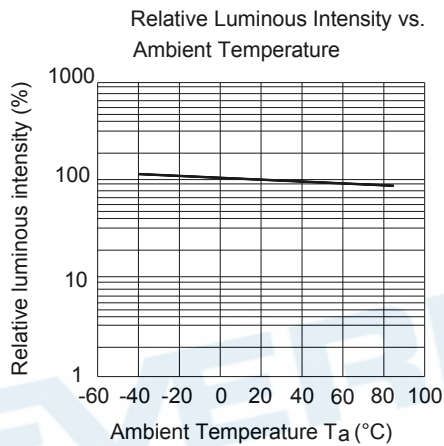
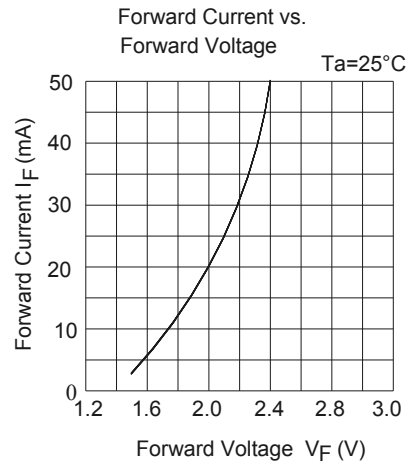
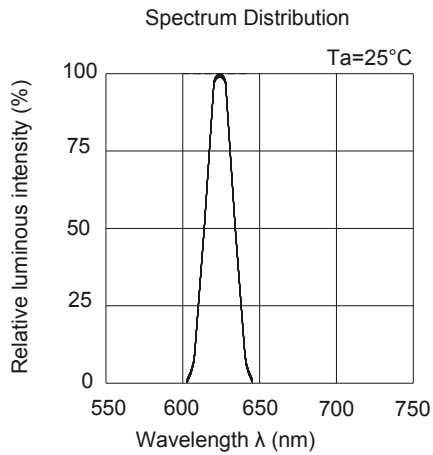



Typical Electro-Optical Characteristics Curves(GH)

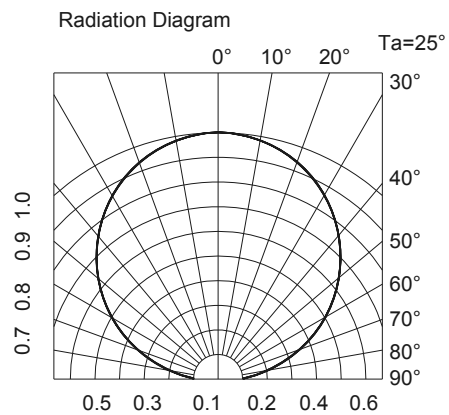
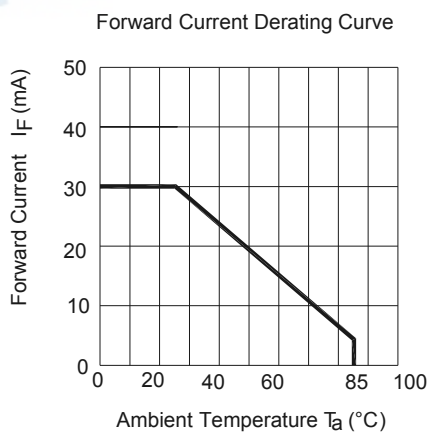
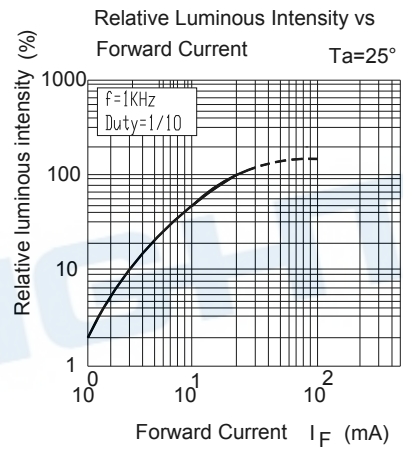
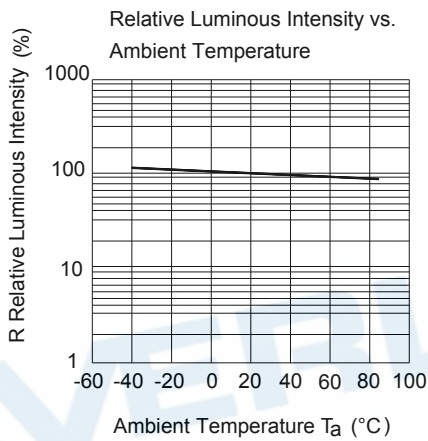
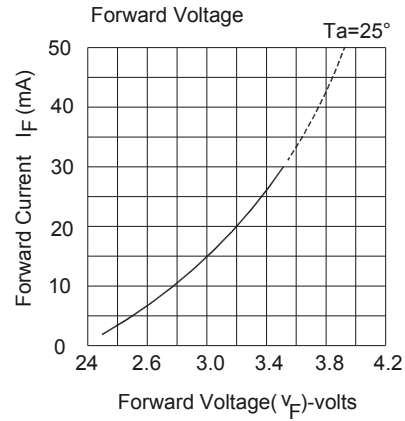
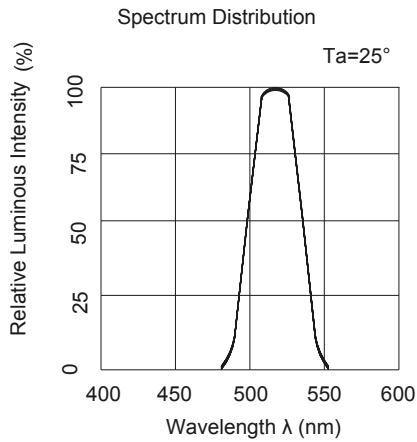

Typical Electro-Optical Characteristics Curves(B7)

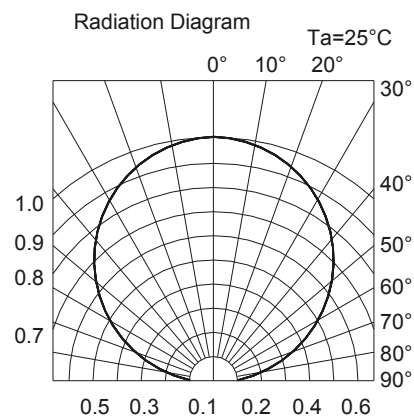
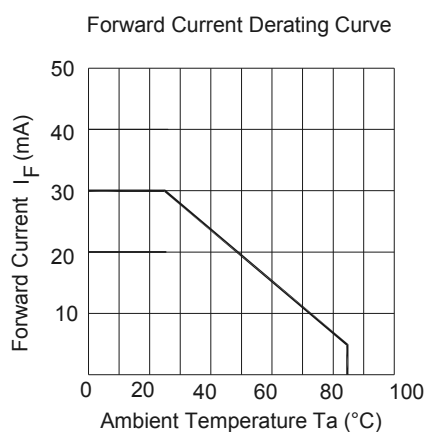
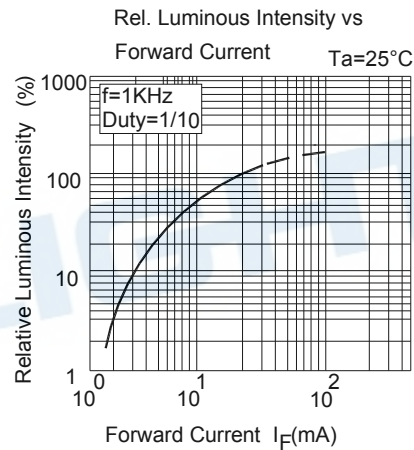
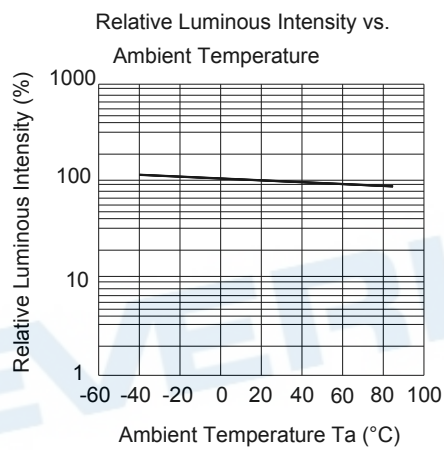
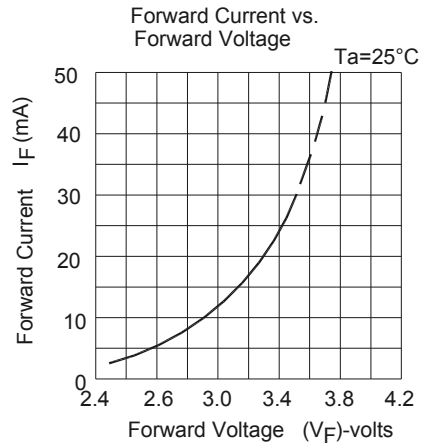
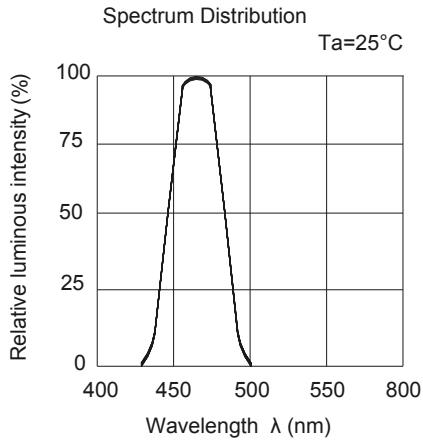

Package Dimension

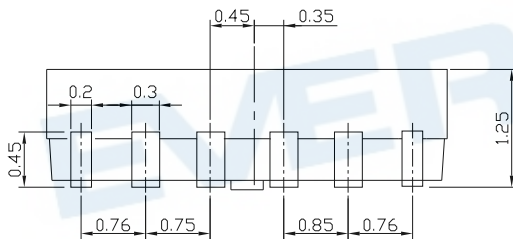
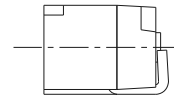
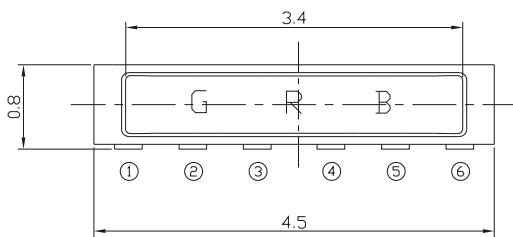
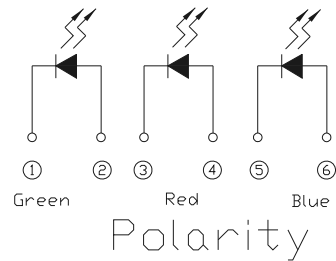
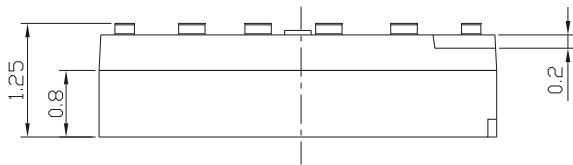

Recommended soldering pad design

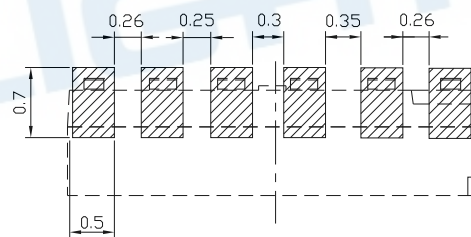

Note: Tolerances unless mentioned  $\pm 0.1\text{mm}$ . Unit = mm

**Label Explanation**

CAT: Luminous Intensity Rank  
 HUE: Dom. Wavelength Rank  
 REF: Forward Voltage Rank

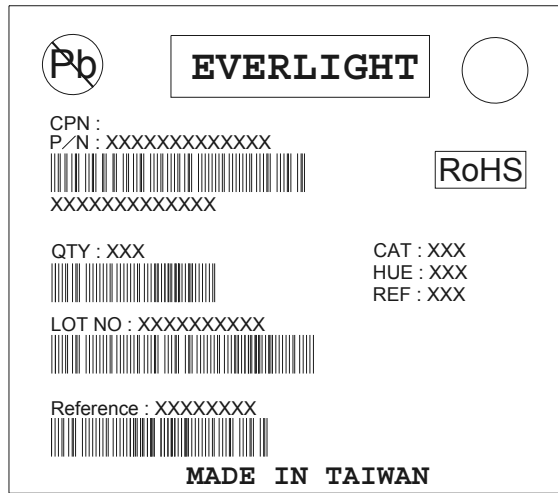

**Reel Dimensions**

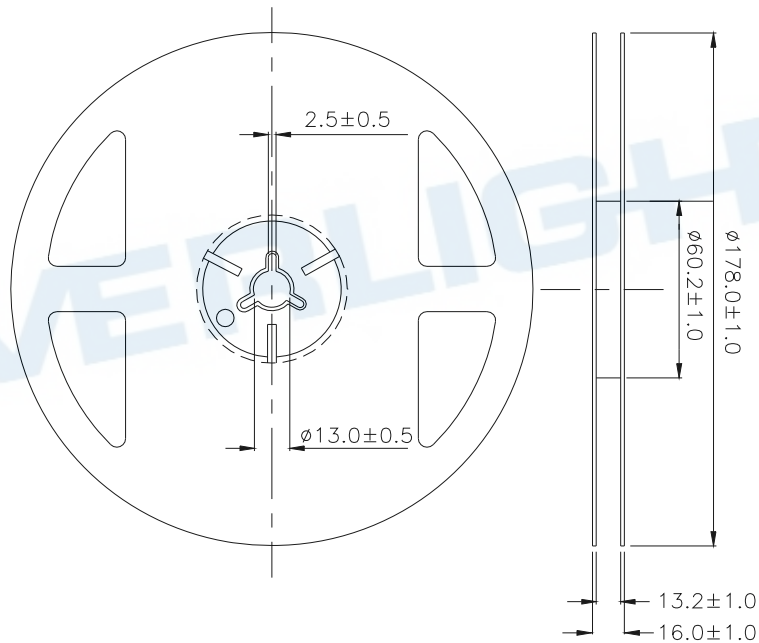

**Note:** Tolerances Unless Dimension ±0.1mm, Unit = mm

**Carrier Tape Dimensions: Loaded Quantity 2000 pcs Per Reel.**

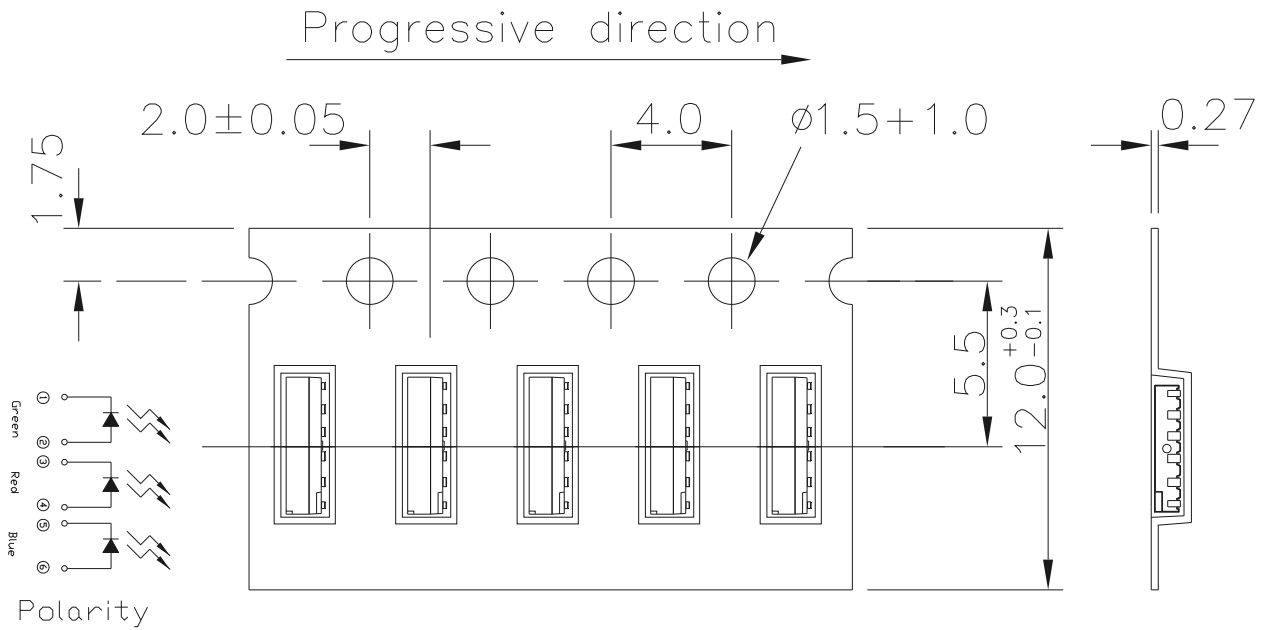

**Note:** Tolerances Unless Dimension  $\pm 0.1\text{mm}$ , Unit = mm

**Moisture Resistant Packaging**

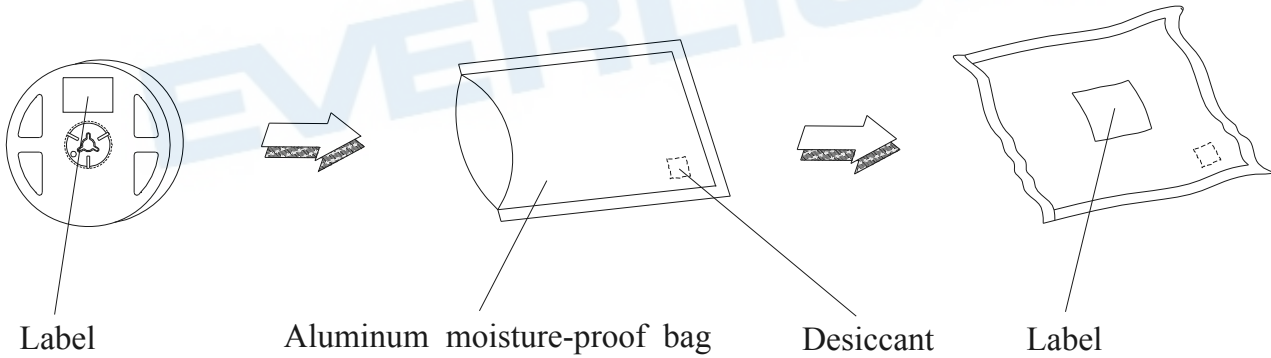

## Precautions for Use

### 1. Over-current-proof

Customer must apply resistors for protection, otherwise slight voltage shift will cause big current change ( Burn out will happen ).

### 2. Storage

2.1 Do not open moisture proof bag before the products are ready to use.

2.2 Before opening the package: The LEDs should be kept at 30°C or less and 90%RH or less.

2.3 After opening the package: The LED's floor life are 168 hours under 30°C or less and 60% RH or less. If unused LEDs remain, it should be stored in moisture proof packages.

2.4 If the moisture absorbent material (silica gel) has faded away or the LEDs have exceeded the storage time, baking treatment should be performed using the following conditions.

Baking treatment : 60±5°C for 24 hours.

### 3. Soldering Condition

#### 3.1 Pb-free solder temperature profile

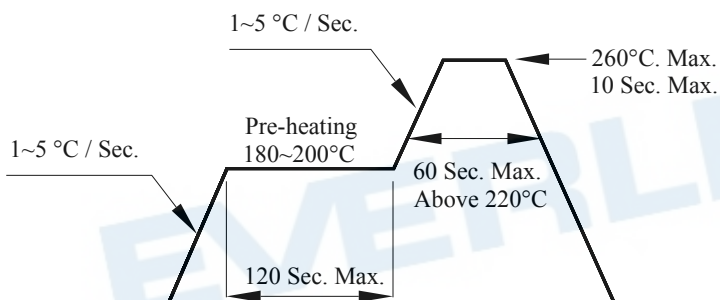

3.2 Reflow soldering should not be done more than two times.

3.3 When soldering, do not put stress on the LEDs during heating.

3.4 After soldering, do not warp the circuit board.

### 4. Soldering Iron

Each terminal is to go to the tip of soldering iron temperature less than 350°C for 3 seconds within once in less than the soldering iron capacity 25W. Leave two seconds and more intervals, and do soldering of each terminal. Be careful because the damage of the product is often started at the time of the hand solder.

### 5. Repairing

Repair should not be done after the LEDs have been soldered. When repairing is unavoidable, a double-head soldering iron should be used (as below figure). It should be confirmed beforehand whether the characteristics of the LEDs will or will not be damaged by repairing.

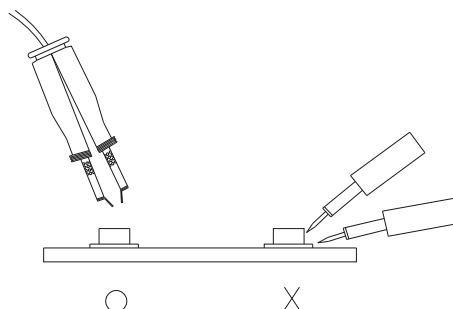

## DISCLAIMER

1. EVERLIGHT reserves the right(s) on the adjustment of product material mix for the specification.
2. The product meets EVERLIGHT published specification for a period of twelve (12) months from date of shipment.
3. The graphs shown in this datasheet are representing typical data only and do not show guaranteed values.
4. When using this product, please observe the absolute maximum ratings and the instructions for using outlined in these specification sheets. EVERLIGHT assumes no responsibility for any damage resulting from the use of the product which does not comply with the absolute maximum ratings and the instructions included in these specification sheets.
5. These specification sheets include materials protected under copyright of EVERLIGHT. Reproduction in any form is prohibited without obtaining EVERLIGHT's prior consent.
6. This product is not intended to be used for military, aircraft, automotive, medical, life sustaining or life saving applications or any other application which can result in human injury or death. Please contact authorized Everlight sales agent for special application request.

## X-ON Electronics

Largest Supplier of Electrical and Electronic Components

*Click to view similar products for [Standard LEDs - SMD category](#):*

*Click to view products by [Everlight manufacturer](#):*

Other Similar products are found below :

[LTST-C190KYKT](#) [LTST-C19GD2WT](#) [LTST-N683GBEW](#) [LTW-170ZDC](#) [LTW-M140SZS40](#) [LTW-M140ZVS](#) [598-8110-100F](#) [91-21SUBCS400-A6TR7](#) [AAAF5060QBFSEEZGS](#) [APT1608QGW](#) [EAST2012YA0](#) [99-213/R6C-AR2T1B/2C](#) [SML-LX0606SISUGC/A](#) [SML-LXR851SIUPGUBC](#) [LT1ED53A](#) [AM27ZGC03](#) [APFA3010SURKCGKQBDC](#) [APHK1608VGCA](#) [APT2012QGW](#) [LTST-008BGEW](#) [LTW-010DCG](#) [LTW-020ZDCG](#) [LTW-21TS5](#) [LTW-220DS5](#) [LO T67F-V1AB-24-1](#) [598-8330-117F](#) [CMDA20AYAA7D1S](#) [95-21SURCS530-A3TR10](#) [HSMQ-C177](#) [598-8040-100F](#) [598-8070-100F](#) [598-8140-100F](#) [598-8610-200F](#) [SML-LXL1209SYC/ATR](#) [CMD91-21VRC/TR7](#) [SML-512PWT86A](#) [SMF-2432GYC-TR](#) [EASV3015RGYA0](#) [LTST-C190KFKT-5A](#) [LTST-C194TBKT-5A](#) [CLX6E-FKC-CH1M1D1BB7C3D3](#) [SML-LXL0805USBC-TR](#) [SML-LX2835SYSUGCTR](#) [LTW-M670ZVS-M5](#) [APA2106ZGC/G](#) [CLMXB-FKA-CbcfghjnpACBB79463](#) [VFA1101W-5AY3B2-TR](#) [LCB P473-P2R2-3J7L-1-Z](#) [HSMR-C197](#) [LW A67C-S2U1-FK0KM0](#)