



Technical Data Sheet

4.7mm Round Type LED Lamps

A93B/UY/S530-A3

■ Features :

- Low power consumption
- High efficiency and low cost
- Good control and free combinations on the colors of LED lamps
- Good lock and easy to assembly
- Stackable and easy to assembly
- Stackable vertically and easy to assembly
- Versatile mounting on P.C board or panel
- Stackable horizontally and easy to assembly
- Pb free
- The product itself will remain within RoHS compliant version.

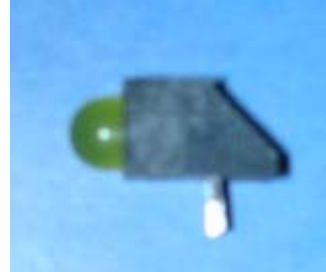

■ Descriptions :

- ARRAY=Plastic Holder+Combinations of Lamps
- The array will easily mount the applicable lamps on any panel up to

■ Applications :

- 1.Used as indicators of indicating the Degree, Functions, Positions etc, in electronic instruments.

PART NO.	Chip		Lens Color
	Material	Emitted Color	
313-2UYD/S530-A3	AlGaInP	Super Yellow	Yellow Diffused

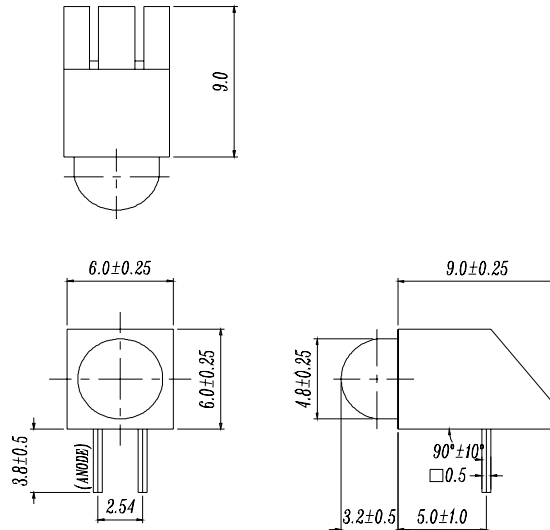
Technical Data Sheet
4.7mm Round Type LED Lamps
A93B/UY/S530-A3
Package Dimensions

- Notes:** 1.All dimensions are in millimeters, tolerance is 0.25mm except being specified
 2.Lead spacing is measured where the lead emerge from the package

Absolute Maximum Ratings at Ta = 25°C

Parameter	Symbol	Rating	Unit
Forward Current	IF	25	mA
Operating Temperature	Topr	-40 to +85	°C
Storage Temperature	Tstg	-40 to +100	°C
Soldering Temperature	Tsol	260 ± 5	°C
Electrostatic Discharge	ESD	2000	V
Power Dissipation	Pd	60	mW
Peak Forward Current	IF(Peak)	160	mA
Reverse Voltage	VR	5	V

Note: *1:IFP Conditions --Pulse Width ≤ 1msec and Duty ≤ 1/10.

*2:Soldering time ≤ 5 seconds.



EVERLIGHT ELECTRONICS CO.,LTD.

Technical Data Sheet

4.7mm Round Type LED Lamps

A93B/UY/S530-A3

Electro-Optical Characteristics (Ta=25°C)

Parameter	Symbol	Condition	Min.	Typ.	Max.	Unit
Forward Voltage	V _F	I _F = 20 mA	/	2.0	2.4	V
Reverse Current	I _R	V _R = 5 V	/	/	10	μA
Luminous Intensity	I _v	I _F = 20 mA	160	320	/	mcd
Viewing Angle	2θ 1/2	I _F = 20 mA	/	35	/	deg
Peak Wavelength	λ _p	I _F = 20 mA	/	591	/	nm
Dominant Wavelength	λ _d	I _F = 20 mA	/	589	/	nm
Spectrum Radiation Bandwidth	Δλ	I _F = 20 mA	/	15	/	nm



Technical Data Sheet

4.7mm Round Type LED Lamps

A93B/UY/S530-A3

■ Typical Electro-Optical Characteristic Curves:

(SUR)

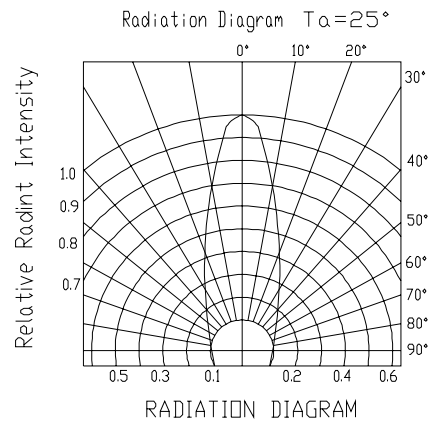
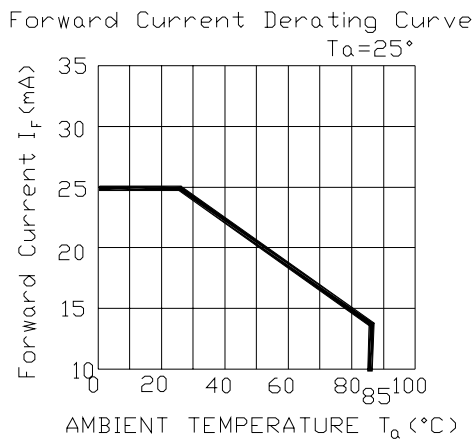
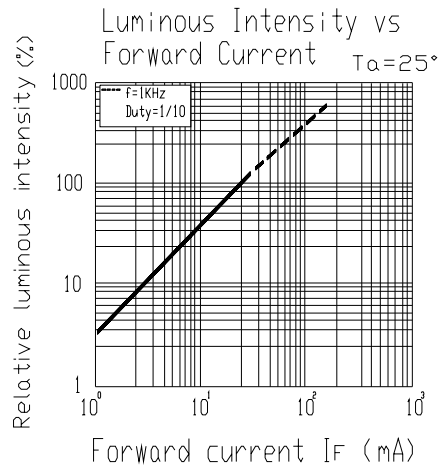
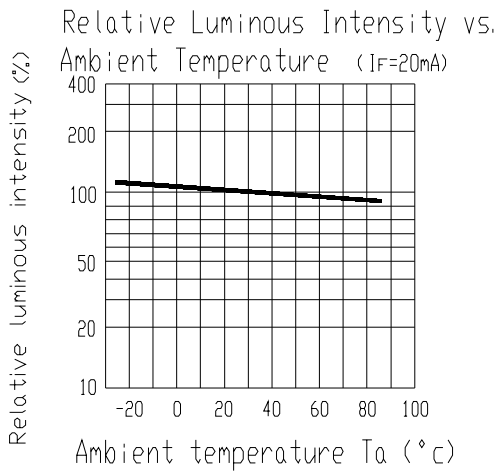
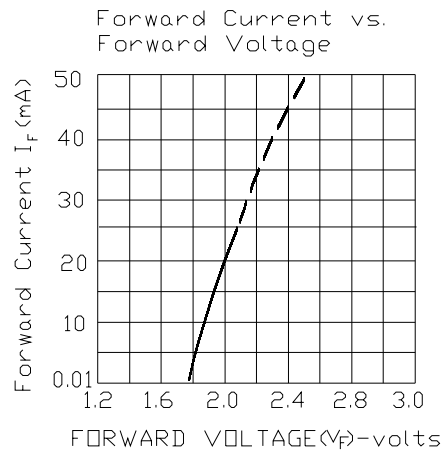
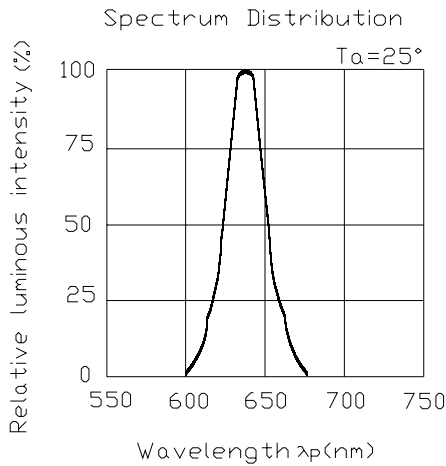



Technical Data Sheet

4.7mm Round Type LED Lamps

A93B/UY/S530-A3

■ Reliability test items and conditions:

NO	Item	Test Conditions	Test Hours/Cycle	Sample Size	Ac/Re
1	Solder Heat	TEMP : 260°C ± 5 °C	10 SEC	76 PCS	0/1
2	Temperature Cycle	H : +100°C 15min ∫ 5 min L : -40°C 15min	300 CYCLES	76 PCS	0/1
3	Thermal Shock	H : +100°C 5min ∫ 10 sec L : -10°C 5min	300 CYCLES	76 PCS	0/1
4	High Temperature Storage	TEMP : 100°C	1000 HRS	76 PCS	0/1
5	Low Temperature Storage	TEMP : -40°C	1000 HRS	76 PCS	0/1
6	DC Operating Life	TEMP : 25°C If = 20mA	1000 HRS	76 PCS	0/1
7	High Temperature / High Humidity	85°C / 85% RH	1000 HRS	76 PCS	0/1



Technical Data Sheet

4.7mm Round Type LED Lamps

A93B/UY/S530-A3

Packing Quantity Specification

- 1. 500PCS/1Bag , 4Bags/1Box
- 2. 10Boxes/1Carton

Label Form Specification

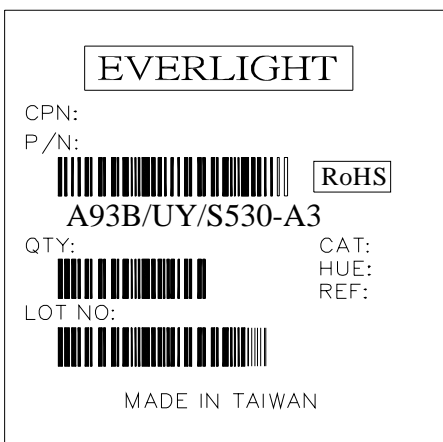

CPN: Customer' s Production Number
P/N : Production Number
QTY: Packing Quantity
CAT: Ranks
HUE: Peak Wavelength
REF: Reference
LOT No: Lot Number
MADE IN TAIWAN: Production Place

Notes

- 1. Above specification may be changed without notice. EVERLIGHT will reserve authority on material change for above specification.
- 2. When using this product, please observe the absolute maximum ratings and the instructions for using outlined in these specification sheets. EVERLIGHT assumes no responsibility for any damage resulting from use of the product which does not comply with the absolute maximum ratings and the instructions included in these specification sheets.
- 3. These specification sheets include materials protected under copyright of EVERLIGHT corporation. Please don' t reproduce or cause anyone to reproduce them without EVERLIGHT' s consent.

<i>EVERLIGHT ELECTRONICS CO., LTD.</i>	<i>Tel: (886-2-2267-2000, 2267-9936</i>
<i>Office: No 25, Lane 76, Sec 3, Chung Yang Rd,</i>	<i>Fax: 886-2267-6244, 2267-6189, 2267-6306</i>
<i>Tucheng, Taipei 236, Taiwan, R.O.C</i>	<i>http:\\www.everlight.com</i>

X-ON Electronics

Largest Supplier of Electrical and Electronic Components

Click to view similar products for [LED Circuit Board Indicators](#) category:

Click to view products by [Everlight](#) manufacturer:

Other Similar products are found below :

[568-0701-841F](#) [LTL-4221NH129](#) [LTL-42DGNMHDP1](#) [HLMP1521101](#) [HLMP1523802F](#) [HLMP1700101F](#) [HLMP1700104F](#) [BHA-1564-G](#)
[SMF-HM1530YD-305](#) [SSF-LXH409SYSUGW](#) [AM2520EHSGD](#) [HLMP1301104F](#) [HLMP1385101F](#) [HLMP1421101](#) [HLMP1503103F](#)
[HLMP1503104F](#) [HLMP1700102F](#) [HLMP1700106F](#) [HLMP1700107F](#) [HLMP1790101F](#) [HLMP1790103F](#) [LTL-4211NHBP](#) [5390H3](#) [551-](#)
[2802F](#) [552-0794-810F](#) [553-0222-812F](#) [HT3-BC-T](#) [564-0700-831F](#) [WP59BLGEW](#) [103-3101-1231-403](#) [5502407811F](#) [550-3007-810F](#) [551-](#)
[3307MF](#) [552080-1](#) [573-2399-100F](#) [592-2020-302F](#) [5932-927-2701-3F](#) [SMF-HM1530SRD-509](#) [SSF-LXH100MID](#) [SSF-LXH2103SRSDRP](#)
[SSF-LXH555USBW](#) [WP937SB/4YGW](#) [WP937EB2EGW](#) [551-0312-802F](#) [553-0110-802F](#) [561-5501-050F](#) [6202T3-5VLC](#) [LTL-307G08A-D](#)
[CMD57164](#) [568-2231-313F](#)