

# EAUVA35352

## 1.8W Series

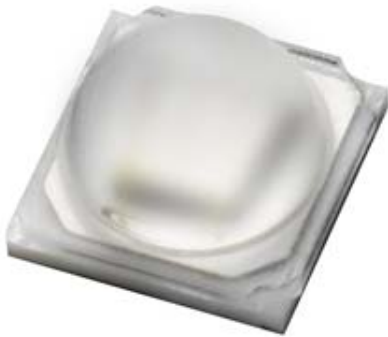

### Introduction

The EAUVA35352 product series is a ceramic based LED with high quality and reliability that suitable for UV application.

### Features

- ◆ High power UVA LED
- ◆ Dimension 3.5mm\* 3.5mm\* 2.35mm
- ◆ ESD protection up to 8KV
- ◆ RoHS compliant
- ◆ Pb free
- ◆ EU REACH compliant
- ◆ Halogen Free compliant  
(Br<900ppm,Cl<900ppm,Br+Cl<1500ppm)

### Applications

- ◆ UV Sterilization System
- ◆ UV Photo-catalyst
- ◆ UV Sensor Light

## Table of Contents

Table of Contents .....	2
Absolute Maximum Ratings .....	3
Electro-Optical Characteristic.....	4
Bin Range of Luminous Flux .....	5
Bin Range of Forward Voltage .....	5
Bin Range of Peak Wavelength .....	5
PN of the EAUVA35352 series: UVA LEDs.....	6
Mechanical Dimension .....	7
Pad Configuration .....	8
Typical Characteristics Curves .....	9
Forward Current V.S. Peak Wavelength.....	9
Forward Current vs. Relative Radiant Flux .....	10
Forward Voltage vs. Forward Current.....	10
Ambient Temp vs. Peak Wavelength.....	11
Ambient Temp vs. Relative Radiant Flux.....	11
Ambient Temp vs. Forward Voltage .....	12
Derating Curve.....	12
Typical Radiation Patterns .....	13
Emitter Tape Packaging.....	14
Emitter Reel Packaging .....	15
Product Labeling .....	15
Storage Conditions .....	錯誤! 尚未定義書籤。 16
Revision History.....	17

## Absolute Maximum Ratings

Parameter	Symbol	Ratings	Unit
Max. DC Forward Current (mA)	$I_F$	700 <sup>[1]</sup>	mA
Max. Peak Pulse Current (mA)	$I_{Pulse}$	1000 <sup>[2]</sup>	mA
Power Dissipation	$P_d$	3	W
Max. ESD Resistance	$V_B$	8000	V
Thermal Resistance	$R_{th}$	5 <sup>[4]</sup>	K/W
Max. Junction Temperature	$T_J$	125 <sup>[5]</sup>	°C
Operating Temperature	$T_{Opr}$	-40 ~ +110	°C
Storage Temperature	$T_{Stg}$	-40 ~ +110	°C

**Notes:**

1. Maximum forward current is 700mA (Thermal Pad=25°C).
2. Duty cycle = 1/10@1KHZ
3. The EAUVA35352 series LEDs are not designed for reverse bias use.
4. Thermal Resistance is from junction to backside of component.
5. Maximum junction temperature of UV is 125°C.

## Electro-Optical Characteristic

Parameter	Symbol	Min.	Typ.	Max	Unit	Condition
Radiant Flux	$\Phi_e$	700	---	---	mW	IF=500mA
Forward Voltage	V <sub>F</sub>	3.4	---	4	V	
Peak Wavelength	$\lambda_p$	---	368	---	nm	
Viewing Angle	$2\theta_{1/2}$	---	120	----	deg	

Parameter	Symbol	Min.	Typ.	Max	Unit	Condition
Radiant Flux	$\Phi_e$	900	---	---	mW	IF=500mA
Forward Voltage	V <sub>F</sub>	3.2	---	3.8	V	
Peak Wavelength	$\lambda_p$	---	385	---	nm	
Viewing Angle	$2\theta_{1/2}$	---	120	----	deg	

Parameter	Symbol	Min.	Typ.	Max	Unit	Condition
Radiant Flux	$\Phi_e$	900	---	---	mW	IF=500mA
Forward Voltage	V <sub>F</sub>	3	---	3.6	V	
Peak Wavelength	$\lambda_p$	---	395	400	nm	
Viewing Angle	$2\theta_{1/2}$	---	120	----	deg	

Parameter	Symbol	Min.	Typ.	Max	Unit	Condition
Radiant Flux	$\Phi_e$	900	---	---	mW	IF=500mA
Forward Voltage	V <sub>F</sub>	3	---	3.6	V	
Peak Wavelength	$\lambda_p$	---	405	---	nm	
Viewing Angle	$2\theta_{1/2}$	---	120	----	deg	

### Notes:

1. Radiant flux measurement tolerance:  $\pm 10\%$ .
2. The data of luminous flux measured at thermal pad=25°C
3. Typical radiant flux or light output performance is operated within the condition guided by this datasheet.

### Bin Range of Luminous Flux

Bin Code	Min.	Max	Unit	Condition
R5	700	800	mW	IF=500mA
R6	800	900		
R7	900	1000		
R8	1000	1300		

**Notes:** Radiant flux measurement tolerance: ±10%.

### Bin Range of Forward Voltage

Group	Bin	Bin Code	Min.	Max	Unit	Condition
C	V1+V2+V3	V1	2.95	3.25	V	IF=500mA
D	V2+V3+V4	V2	3.25	3.55		
E	V3+V4+V5	V3	3.55	3.85		
F	V1+V2	V4	3.85	4.15		

**Notes:** Tolerance of Forward Voltage: ±0.1V.

### Bin Range of Peak Wavelength

Group	Bin	Min.	Max	Unit	Condition
P UVA	1	360	365	nm	IF=500mA
	2	365	370		
	3	370	375		
	4	375	380		
	5	380	385		
	6	385	390		
	7	390	395		
	8	395	400		
	9	400	405		
	0	405	410		

## PN of the EAUVA35352 series: UVA LEDs

The table below is a list of part numbers for the Everlight EcaUVA35352 1.8W series UVA LED. Typical view angle is 120°. These clearly listed binning options allow for proper design and implementation into UV applications. The Order Codes below are currently available UVA EAUVA35352 LEDs.

For Example: If you order product using P/N : EAUVA35352BC5 , you will be specifying:



Color	Typ. Peak Wavelength (nm)	Forward Voltage (V)	Minimum Radiant Flux (mW)
UV	368	3.6	700

UV, EAUVA35352 series LEDs at 500mA are listed below

Color	Order Code of EAUVA35352	Minimum Radiant Flux (mW)	Peak Wavelength (nm)	Forward Voltage (V)
Ultraviolet	EAUVA35352BC5	700	365~375	3.25-4.15
	EAUVA35352BC6	800	365~375	3.25-4.15
	EAUVA35352BC7	900	365~375	3.25-4.15
	EAUVA35352BC8	1000	365~375	3.25-4.15
	EAUVA35352EF7	900	380~390	2.95-3.85
	EAUVA35352EF8	1000	380~390	2.95-3.85
	EAUVA35352GH7	900	390~400	2.95-3.85
	EAUVA35352GH8	1000	390~400	2.95-3.85
	EAUVA35352IJ7	900	400~410	2.95-3.85
	EAUVA35352IJ8	1000	400~410	2.95-3.85

## Mechanical Dimension

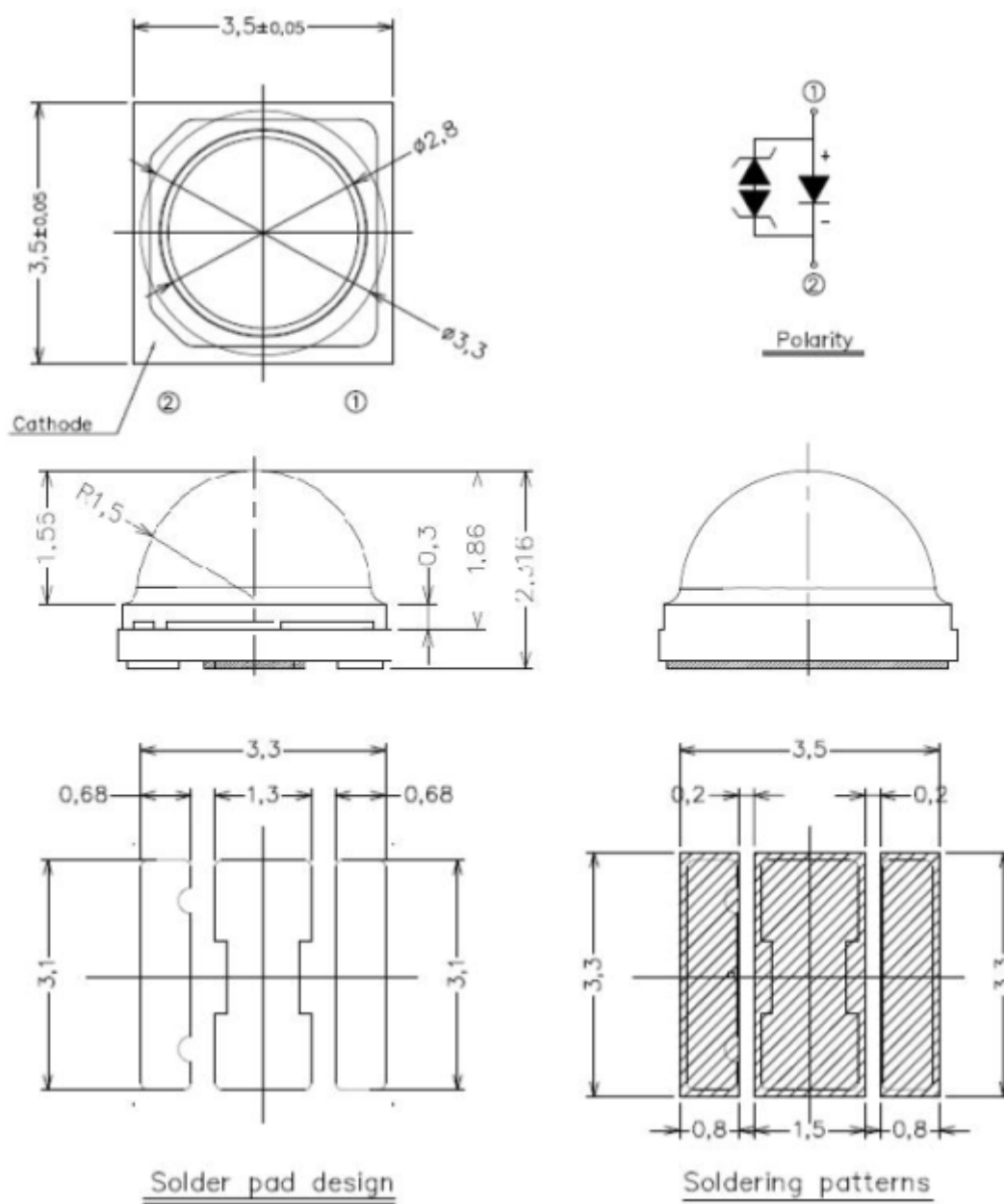

1. Dimensions are in millimeters.
2. Tolerances unless mentioned are  $\pm 0.1$ mm

## Pad Configuration

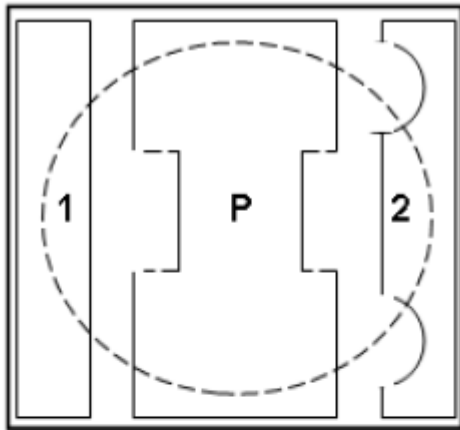

BOTTOM VIEW

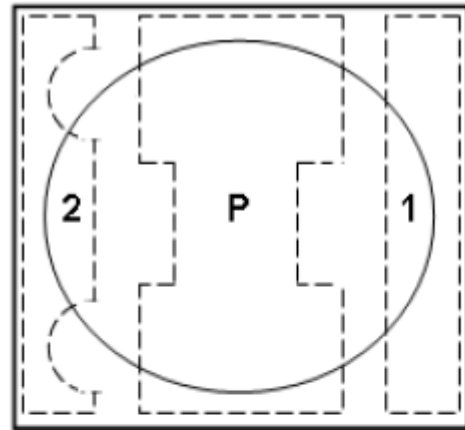

TOP VIEW

PAD	FUNCTION
1	ANODE
2	CATHODE
P	THERMAL PAD



### Typical Characteristics Curves Spectrum @ Thermal Pad Temperature = 25°C

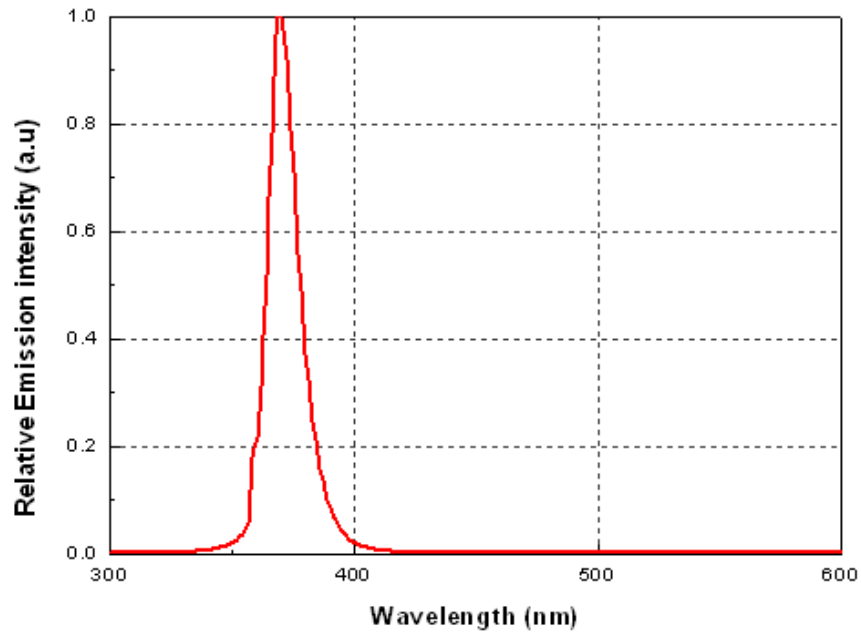

### Forward Current V.S. Peak Wavelength @ Thermal Pad Temperature = 25°C

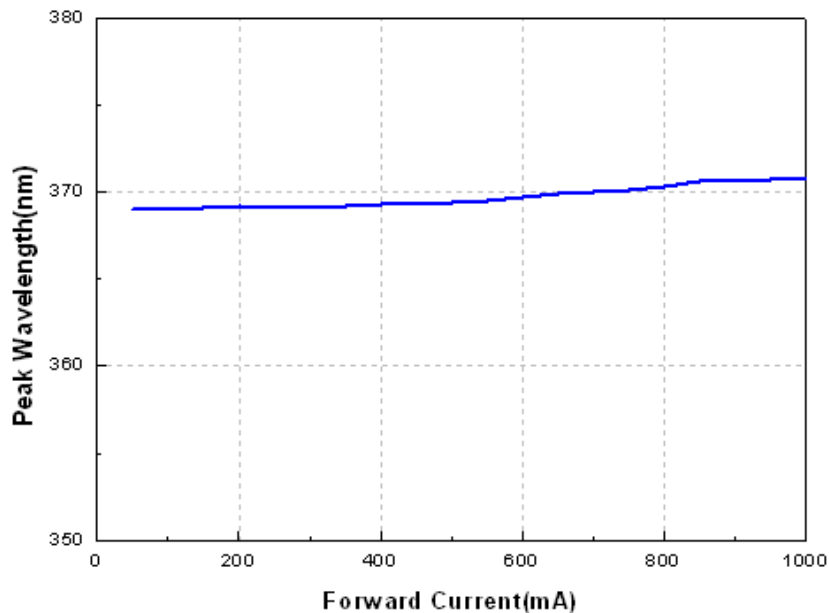

## Forward Current vs. Relative Radiant Flux @ Thermal Pad Temperature = 25°C

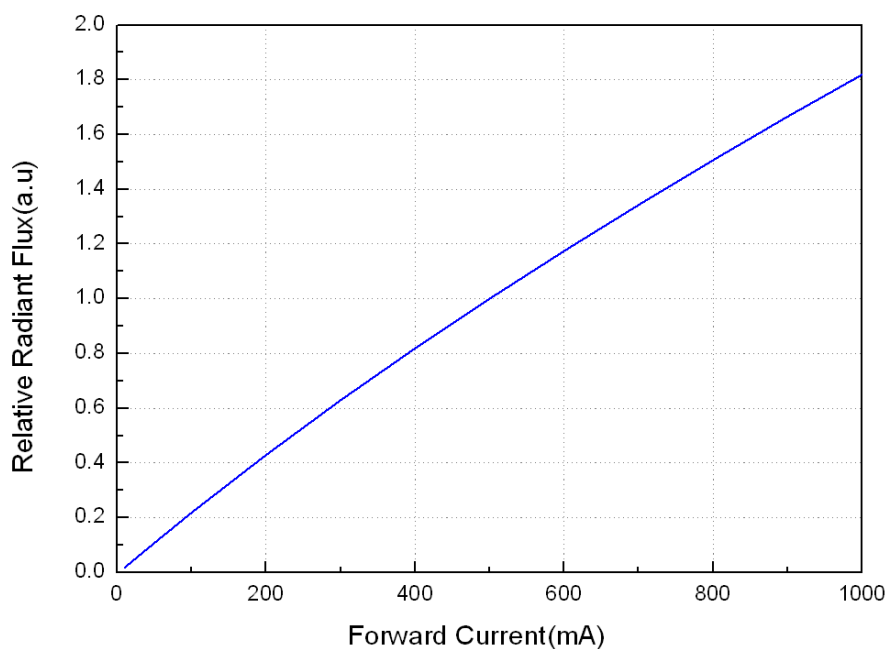

## Forward Voltage vs. Forward Current @ Thermal Pad Temperature = 25°C

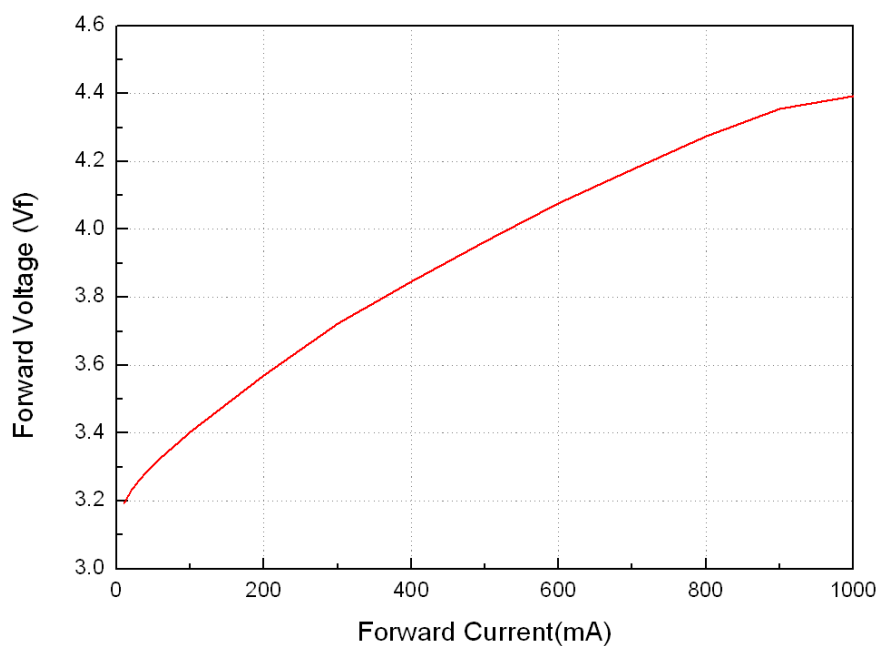

## Ambient Temp vs. Peak Wavelength

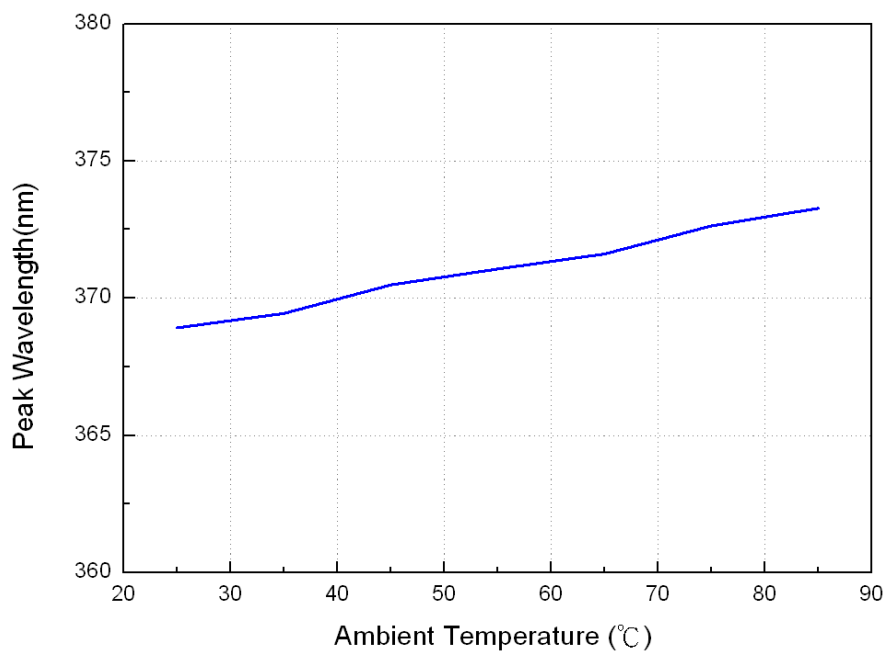

## Ambient Temp vs. Relative Radiant Flux

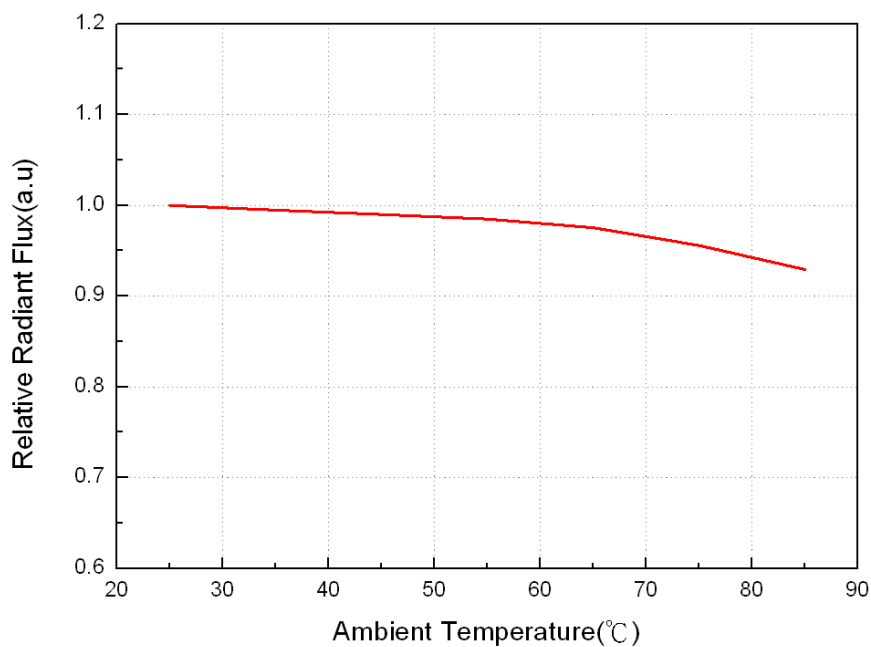

## Ambient Temp vs. Forward Voltage

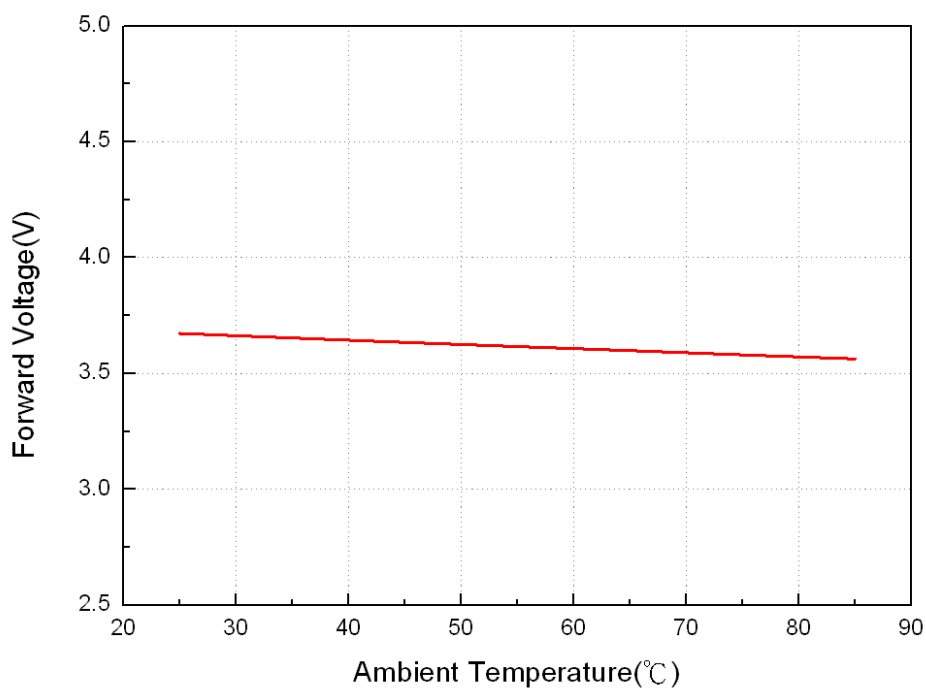

## Derating Curve

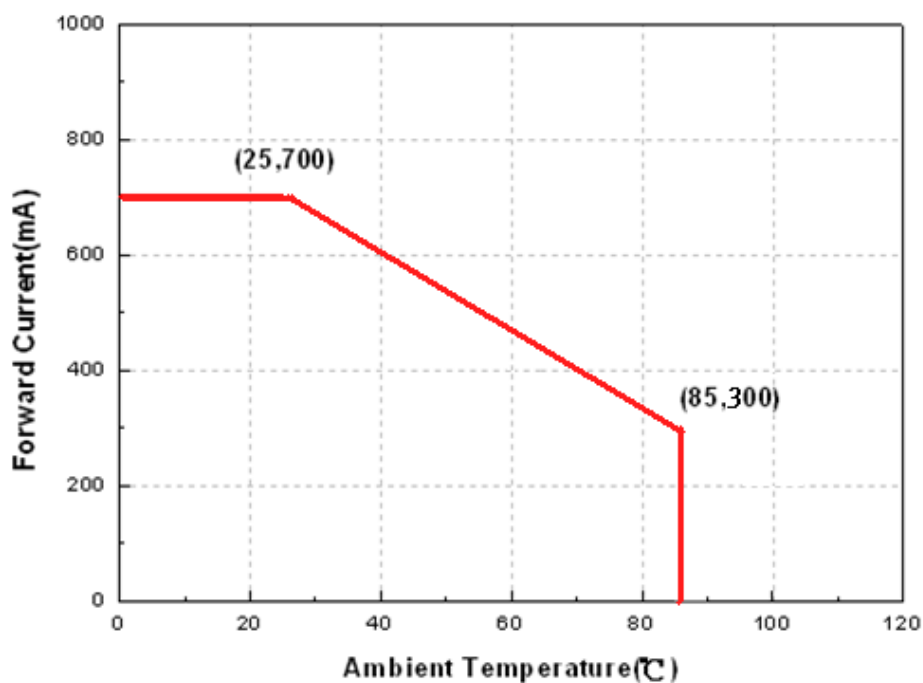

## Typical Radiation Patterns

### Typical Diagram Characteristics of Radiation for EAUVA35352

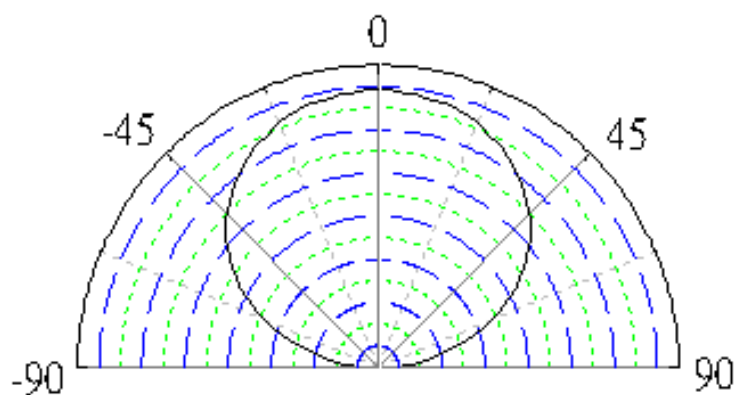

**Notes:**

1.  $2\theta_{1/2}$  is the off axis angle from lamp centerline where the luminous intensity is 1/2 of the peak value.
2. View angle tolerance is  $\pm 5^\circ$  .

## Emitter Tape Packaging

Carrier Tape Dimensions as the following:

Reel: 2000pcs

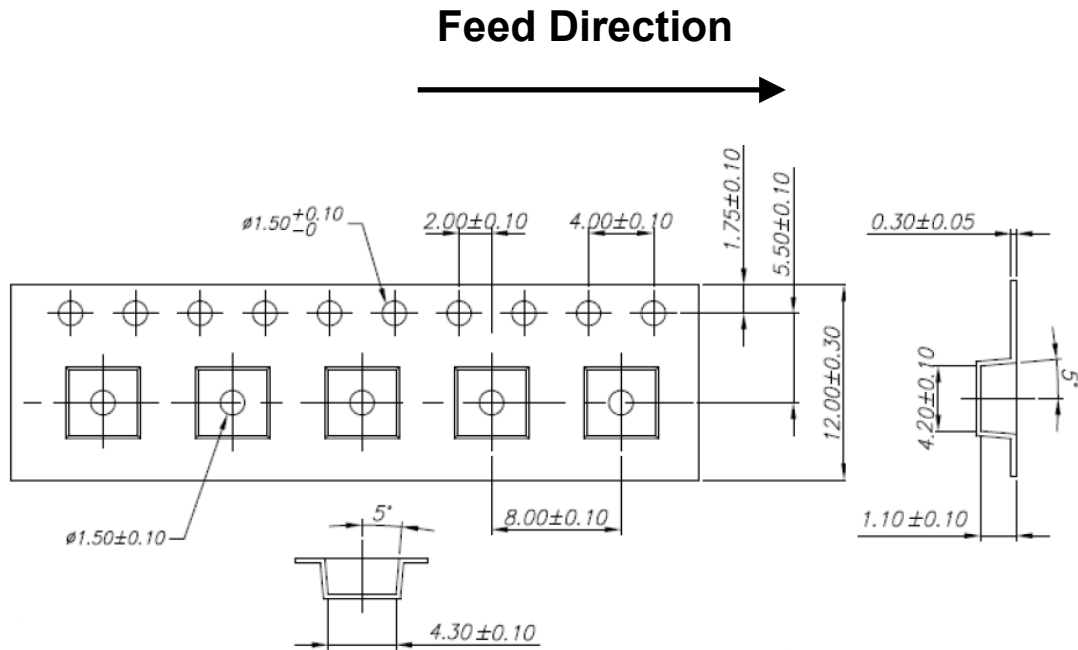

**Notes:**

1. Tolerance unless mentioned is  $\pm 0.1\text{mm}$ ; Unit = mm
2. Minimum packing amount is 250/500/1000/2000 pcs per reel

### Moisture Resistant Packaging

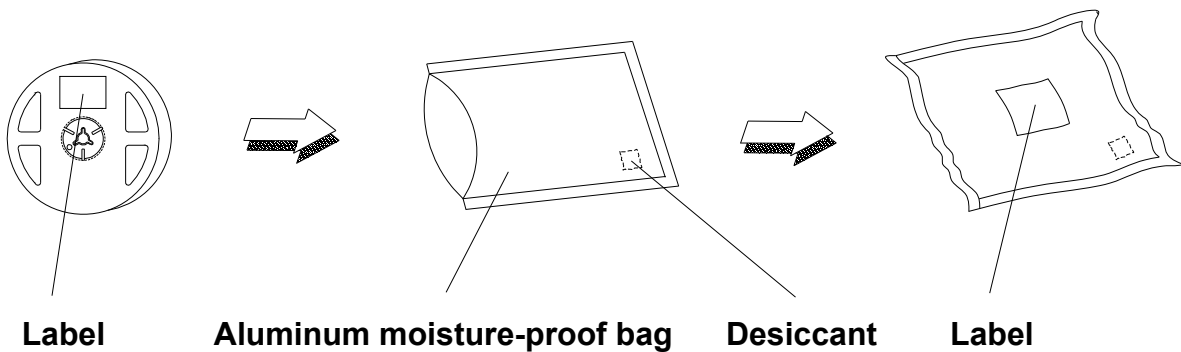

## Emitter Reel Packaging

### Reel Dimensions

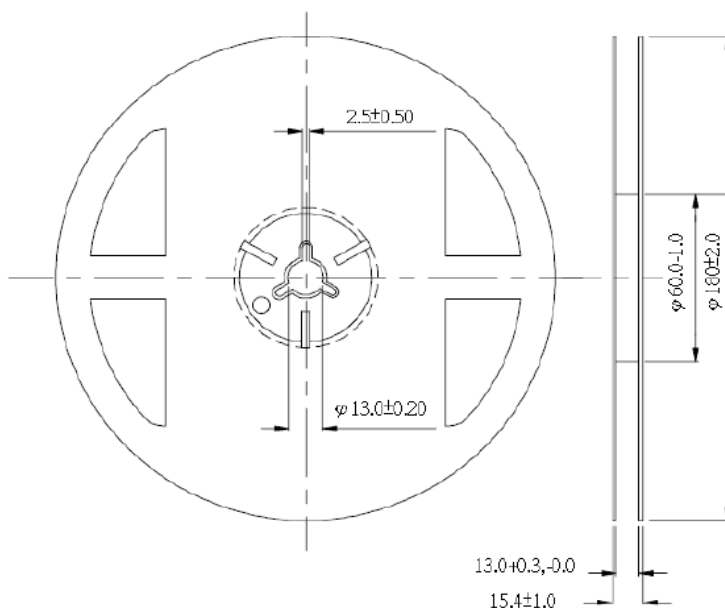

#### Notes:

1. Dimensions are in millimeters.
2. Tolerances unless mentioned are  $\pm 0.1$ mm.

## Product Labeling

### Label Explanation

CPN: Customer Specification (when required)

P/N : Everlight Production Number

QTY: Packing Quantity

CAT: Luminous Flux (Brightness) Bin

HUE: Color Bin

REF: Forward Voltage Bin

LOT No: Lot Number

MADE IN TAIWAN: Production Place

RoHS	(Pb)	<b>EVERLIGHT</b>	<b>5</b>
CPN : XXXXXXXXXXXXXXXXXXXXXXXX			
XXXXXXXXXX-XXXXXXXXXX-XXXXXXXXXX-XXXXXXXXXX-XXXXXX			
P/N : XXXXXXXXXXXXX			
XXXXXXXXXX-XXXXXXXXXX-XXXXXXXXXX-XXXXXXXXXX-XXXXXX			
LOT NO: Y150716XXX-XXXXXXXXXX-XXXXXXXXXX			
QTY: 0123456789 HUE: XXXXXXXXXXXX			
CAT: XXXXXXXXXXXX REF: XXXXXXXXXXXX			
REFERENCE: BTPYYMDDXXXXX			
MSL-X MADE IN XXXXXXXX			



## Storage Conditions

- Before the package is opened. The LEDs should be stored at 30°C or less and 90%RH or less after being shipped from EVERLIGHT and the storage life limits are 12 months.
- If the moisture absorbent material (silica gel) has faded away or the LEDs have exceeded the storage time, baking treatment should be performed using the following conditions. Baking treatment: 60±5°C for 24 hours.

## DISCLAIMER

- EVERLIGHT reserves the right(s) on the adjustment of product material mix for the specification.
- The product meets EVERLIGHT published specification for a period of twelve (12) months from date of shipment.
- The graphs shown in this datasheet are representing typical data only and do not show guaranteed values.
- When using this product, please observe the absolute maximum ratings and the instructions for using outlined in these specification sheets. EVERLIGHT assumes no responsibility for any damage resulting from the use of the product which does not comply with the absolute maximum ratings and the instructions included in these specification sheets.
- These specification sheets include materials protected under copyright of EVERLIGHT. Reproduction in any form is prohibited without obtaining EVERLIGHT's prior consent.
- This product is not intended to be used for military, aircraft, automotive, medical, life sustaining or life saving applications or any other application which can result in human injury or death. Please contact authorized EVERLIGHT sales agent for special application request.



## Revision History

Current version: **2017.1.16**

Previous version: **N/A**

Device No.

Rev. Ver. 4

Page	Subjects (major change in previous version)	Date of change
6	Add EAUVA35352 PN list.	2016.6.2
16	Revise storage conditions and add disclaimer.	2017.1.16
6	Add EAUVA35352 PN list.	2017.3.2

## X-ON Electronics

Largest Supplier of Electrical and Electronic Components

*Click to view similar products for [High Power LEDs - Single Colour](#) category:*

*Click to view products by [Everlight](#) manufacturer:*

Other Similar products are found below :

[GA CSSPM1.23-KTLP-W3-0-350-R18](#) [L135-L567003500000](#) [L1CU-VLT1000000000](#) [L1C1-VLT1000000000](#) [KY DDLM31.FY-8H7J-5F5G-W4A4-140-R18](#) [KY DDLM31.23-8F5H-36-C4U4-140-R18](#) [LS G6SP.01-7C8D-68-G3R3](#) [KR DDLM31.23-5G7H-25-C4U4-140-R18](#) [KT DDLM31.13-6H7J-36-W4A4-140-R18](#) [KS DDLM31.23-8E6G-68-C4U4-140-R18](#) [KB DDLM31.13-6D7E-25-24A4-140-R18](#) [GT CS8PM1.13-LSLU-26-1-350-B-R18](#) [XPEBRY-L1-0000-00S02](#) [SPHWH2L3D30ED4V0H3](#) [LUWCQ7P-LPLR-5E8G-1-K](#) [LTPL-C034UVH410](#) [XPEROY-L1-0000-00B02](#) [GD CSSPM1.14-UOVJ-W4-1](#) [LST1-01F06-GRN1-00](#) [KY DMLS31.23-8J7L-46-M3W3](#) [KY DMLQ31.23-HYKX-46-J3T3](#) [GD CS8PM1.14-UOVJ-W4-1](#) [XQEEPR-00-0000-000000A01-SB01](#) [LST1-01G01-UV02-00](#) [LST1-01F06-RYL1-00](#) [LST1-01F06-FRD1-00](#) [LST1-01G01-UV01-00](#) [LST1-01G01-PRD1-00](#) [XQEROY-00-0000-000000Q01-SB01](#) [LST1-01G01-UV03-00](#) [LST1-01G01-RYL1-00](#) [L135-A589003500000](#) [L135-L567L00000000](#) [L1C1-GRN1000000000](#) [LA G6SP-DAFA-24-1](#) [LS G6SP-CADB-1-1-Z](#) [LY H9PP-HZJZ-46-1](#) [SMTL6-RC](#) [MLEBLU-A1-0000-000U01](#) [MLEBLU-A1-0000-000U05](#) [MLEGRN-A1-0000-000101](#) [MLESRD-A1-0000-000W01](#) [XBDAMB-00-0000-000000701](#) [XBDAMB-00-0000-000000801](#) [XBDBLU-00-0000-000000201](#) [XBDBLU-00-0000-000000202](#) [XBDGRN-00-0000-000000B01](#) [XBDGRN-00-0000-000000C01](#) [XBDGRN-00-0000-000000C02](#) [XBDGRN-00-0000-000000D02](#)