

### 4 PIN SOP HIGH VOLTAGE PHOTODARLINGTON PHOTOCOUPLER EL452-G Series

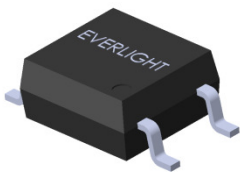

Schematic

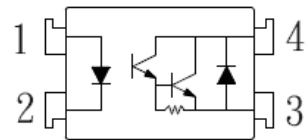

Pin Configuration

1. Anode
2. Cathode
3. Emitter
4. Collector

#### Features:

- Halogens free
- High collect-Emitter voltage ( $V_{CEO} = 350V$ )
- Current transfer ratio  
(CTR: Min. 1000% at  $I_F = 1mA, V_{CE} = 2V$ )
- High isolation voltage between input and output  
( $V_{iso} = 3750 V rms$ )
- Compact 4 Pin SOP with a 2.0 mm profile
- Pb free and RoHS compliant.
- UL & CUL approved
- VDE approved
- SEMKO approved
- NEMKO approved
- DEMKO approved
- FIMKO approved

#### Description

The EL452-G contains an infrared emitting diode, optically coupled to a high voltage darlington phototransistor.

It is packaged in a 4-pin small outline SMD package.

#### Applications

- Telephone set, telephone exchangers
- Sequence controllers
- System appliances, measuring instruments
- Signal transmission between circuits of different potentials and impedance

**Absolute Maximum Ratings (Ta=25°C)**

	Parameter	Symbol	Rating	Unit
Input	Forward current	$I_F$	60	mA
	Peak forward current (t = 10μs)	$I_{FM}$	1	A
	Power dissipation	$P_D$	100	mW
Output	Power dissipation	$P_C$	150	mW
	Collector current	$I_C$	150	mA
	Collector-Emitter voltage	$V_{CEO}$	350	V
	Emitter-Collector voltage	$V_{ECO}$	0.1	V
	Total power dissipation	$P_{TOT}$	170	mW
	Isolation voltage <sup>*1</sup>	$V_{ISO}$	3750	V rms
	Operating temperature	$T_{OPR}$	-55~+110	°C
	Storage temperature	$T_{STG}$	-55~+125	°C
	Soldering Temperature <sup>*2</sup>	$T_{SOL}$	260	°C

Notes:

\*1 AC for 1 minute, R.H.= 40 ~ 60% R.H. In this test, pins 1 & 2 are shorted together, and pins 3 & 4 are shorted together.

\*2 For 10 seconds

**Electro-Optical Characteristics (Ta=25°C unless specified otherwise)**

**Input**

Parameter	Symbol	Min.	Typ.*	Max.	Unit	Condition
Forward Voltage	$V_F$	-	1.2	1.4	V	$I_F = 10\text{mA}$
Reverse Current	$I_R$	-	-	10	$\mu\text{A}$	$V_R = 4\text{V}$
Input capacitance	$C_{in}$	-	50	-	pF	$V = 0, f = 1\text{KHz}$

**Output**

Parameter	Symbol	Min.	Typ.*	Max.	Unit	Condition
Collector-Emitter dark current	$I_{CEO}$	-	-	100	nA	$V_{CE} = 200\text{V}, I_F = 0\text{mA}$
Collector-Emitter breakdown voltage	$BV_{CEO}$	350	-	-	V	$I_C = 0.1\text{mA}$
Emitter-Collector breakdown voltage	$BV_{ECO}$	0.1	-	-	V	$I_E = 0.01\text{mA}$

**Transfer Characteristics**

Parameter	Symbol	Min.	Typ.*	Max.	Unit	Condition
Current Transfer ratio	CTR	1000	2000	-	%	$I_F = 1\text{mA}, V_{CE} = 2\text{V}$
Collector-emitter saturation voltage	$V_{CE(sat)}$	-	1.2	1.5	V	$I_F = 20\text{mA}, I_C = 100\text{mA}$
Isolation resistance	$R_{IO}$	$5 \times 10^{10}$	$10^{11}$	-	$\Omega$	$V_{IO} = 500\text{Vdc}, 40 \sim 60\% R.H$
Cut-off frequency	$f_c$	-	7	-	KHz	$V_{CE} = 2\text{V}, I_C = 2\text{mA}, R_L = 100\Omega, -3\text{db}$
Floating capacitance	$C_{IO}$	-	0.6	-	pF	$V_{IO} = 0, f = 1\text{MHz}$
Rise time	$t_r$	-	80	250	$\mu\text{s}$	$V_{CE} = 2\text{V}, I_C = 20\text{mA}, R_L = 100\Omega$
Fall time	$t_f$	-	10	100	$\mu\text{s}$	

\* Typical values at  $T_a = 25^\circ\text{C}$

Typical Electro-Optical Characteristics Curves

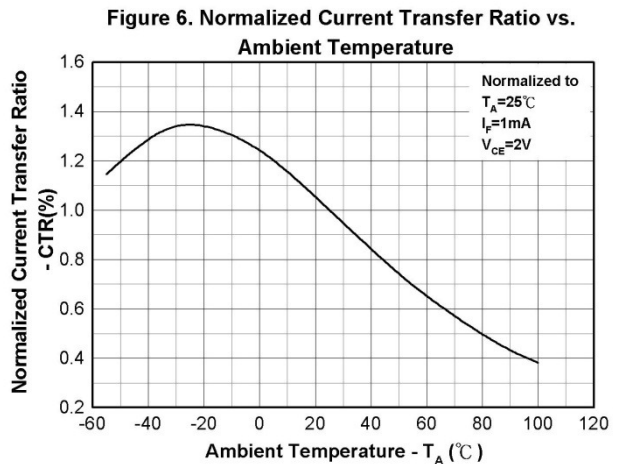
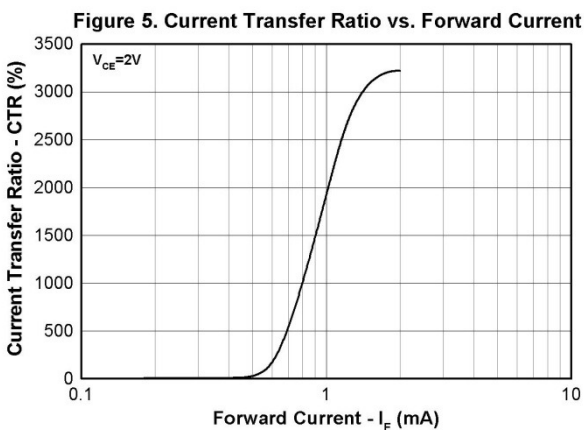
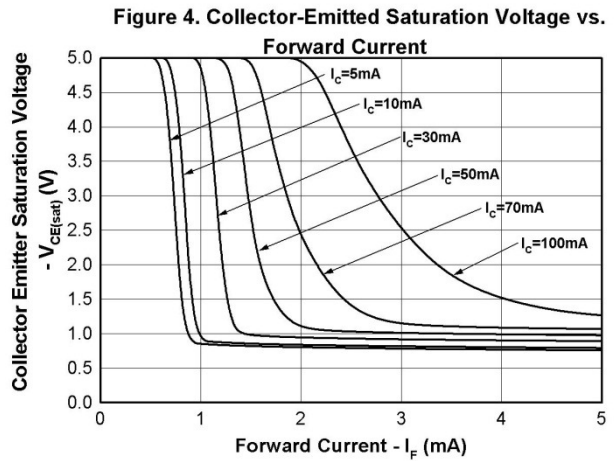
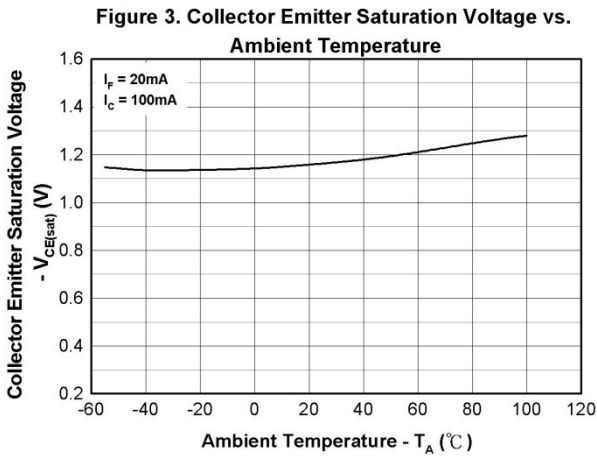
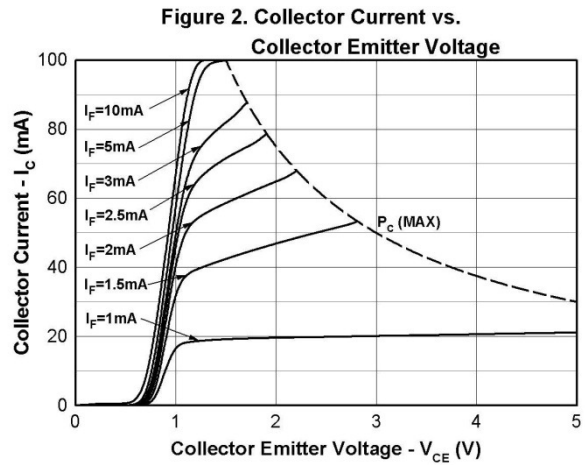
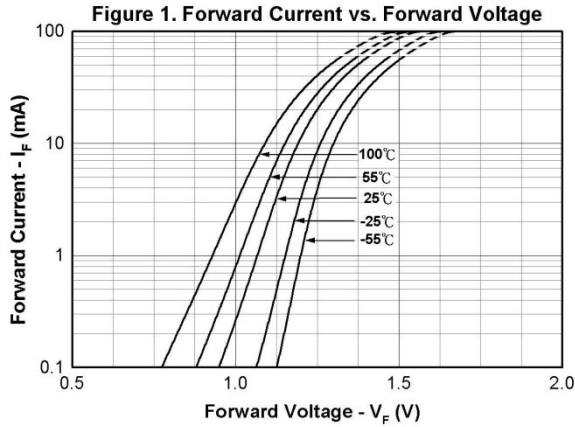

Figure 7. Collector Dark Current vs. Ambient Temperature

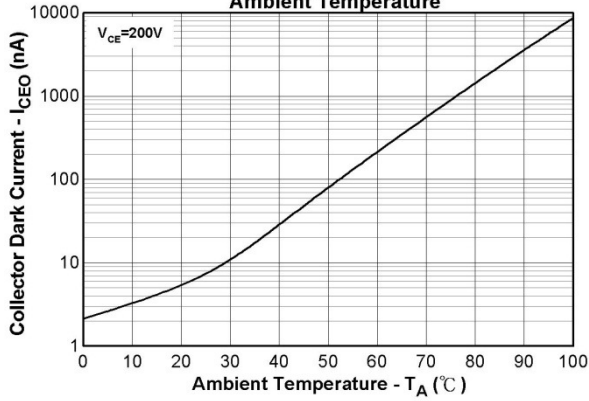

Figure 8. Response Time vs. Load Resistance

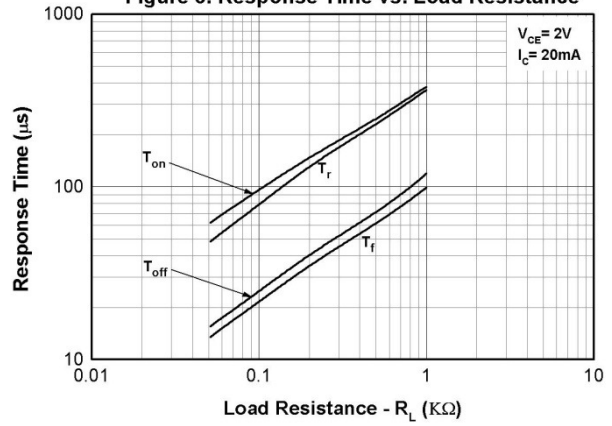
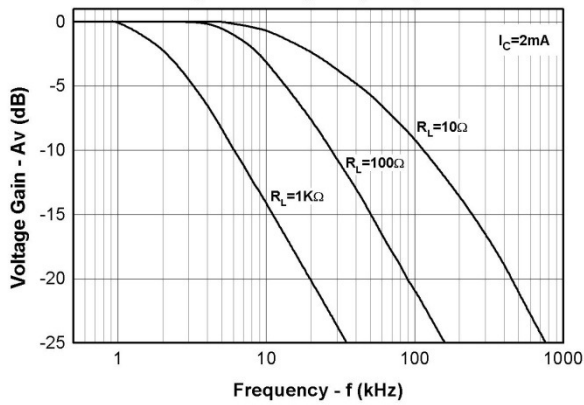

Figure 9. Frequency Response



## Order Information

### Part Number

**EL452(Y)-VG**

### Note

Y = Tape and reel option (TA, TB, or none).

V = VDE safety (optional)

G = Halogens free

Option	Description	Packing quantity
None	Standard SMD option	100 units per tube
-V	Standard SMD option + VDE	100 units per tube
(TA)	TA Tape & reel option	3000 units per reel
(TB)	TB Tape & reel option	3000 units per reel
(TA)-V	TA Tape & reel option + VDE	3000 units per reel
(TB)-V	TB Tape & reel option + VDE	3000 units per reel

**Package Dimension (Dimensions in mm)**

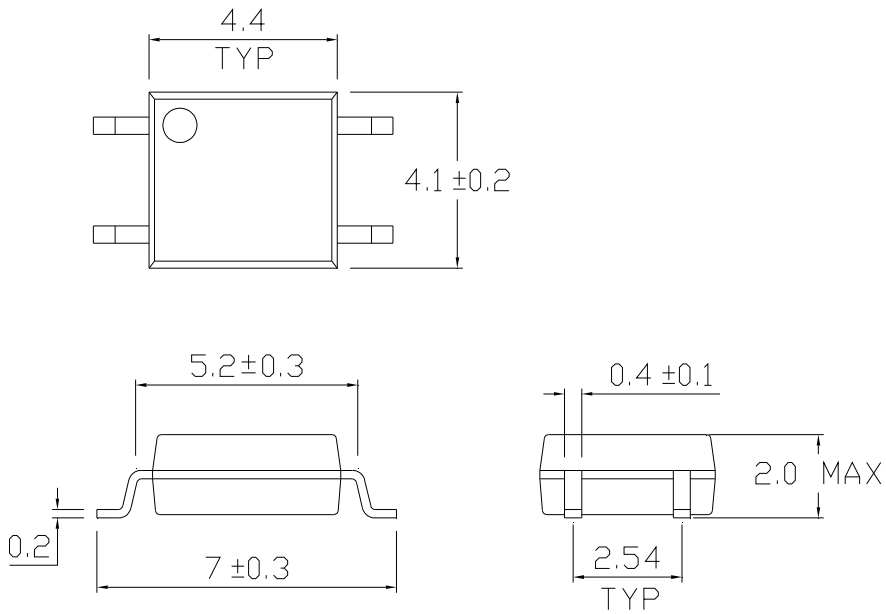

**Recommended pad layout for surface mount leadform**

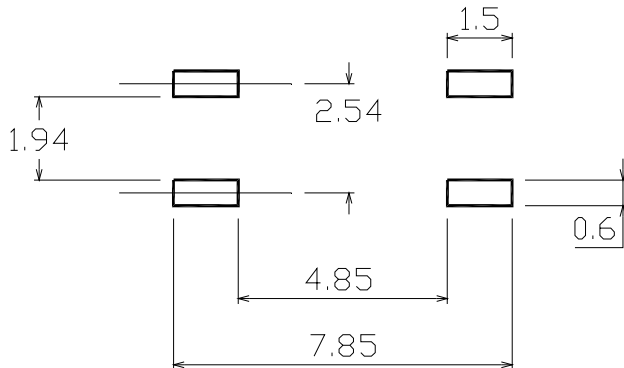

## Device Marking



## Notes

EL	denotes Everlight
452	denotes Part Number
Y	denotes 1 digit Year code
WW	denotes 2 digit Week code
V	denotes VDE approved (optional)



**Tape & Reel Packing Specifications**

**Option TA**

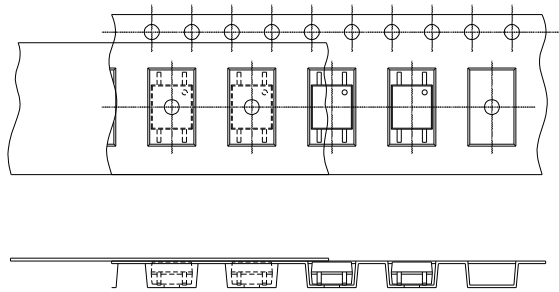

Direction of feed from reel

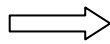

**Option TB**

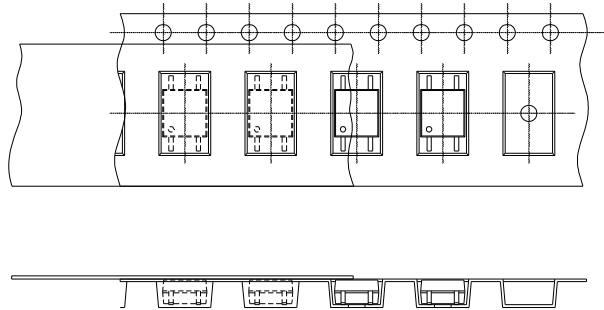

Direction of feed from reel

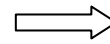

**Tape dimensions**

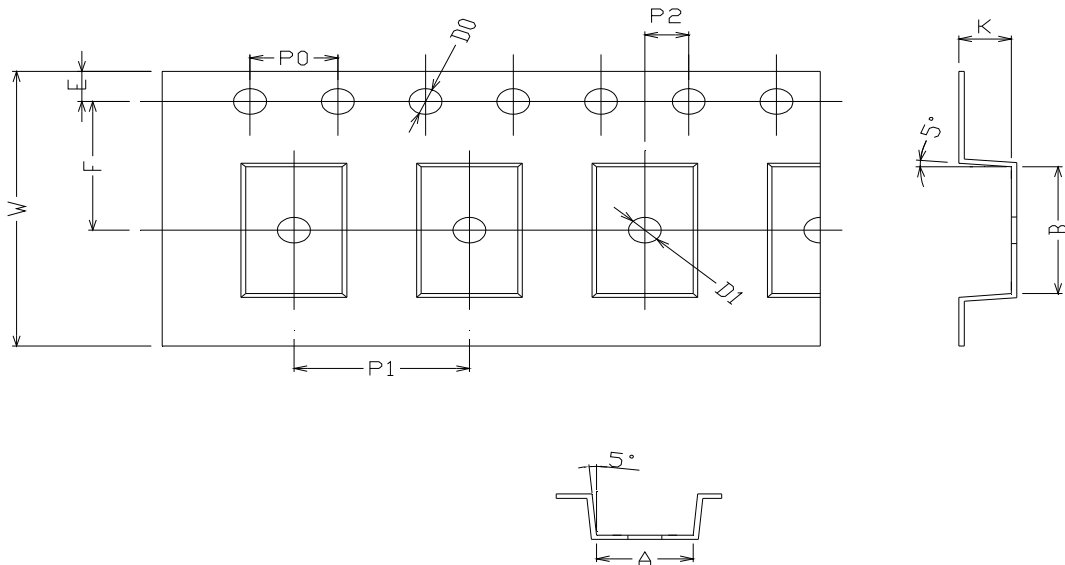

Dimension No.	<b>A</b>	<b>B</b>	<b>Do</b>	<b>D1</b>	<b>E</b>	<b>F</b>
Dimension(mm)	4.4 ± 0.1	7.4 ± 0.1	1.5 + 0.1/-0	1.5 ± 0.1	1.75 ± 0.1	7.5 ± 0.1
Dimension No.	<b>Po</b>	<b>P1</b>	<b>P2</b>	<b>t</b>	<b>W</b>	<b>K</b>
Dimension(mm)	4.0 ± 0.15	8.0 ± 0.1	2.0 ± 0.1	0.25 ± 0.03	16.0 ± 0.2	2.4 ± 0.1

## Precautions for Use

### 1. Soldering Condition

#### 1.1 (A) Maximum Body Case Temperature Profile for evaluation of Reflow Profile

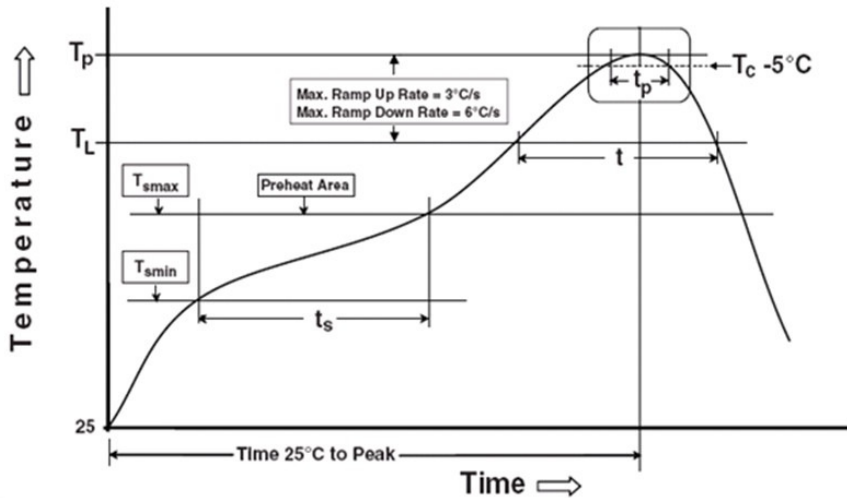

Note:

Reference: IPC/JEDEC J-STD-020D

#### Preheat

Temperature min ( $T_{smin}$ )	150 °C
Temperature max ( $T_{smax}$ )	200 °C
Time ( $T_{smin}$ to $T_{smax}$ ) ( $t_s$ )	60-120 seconds
Average ramp-up rate ( $T_{smax}$ to $T_p$ )	3 °C/second max

#### Other

Liquidus Temperature ( $T_L$ )	217 °C
Time above Liquidus Temperature ( $t_L$ )	60-100 sec
Peak Temperature ( $T_p$ )	260 °C
Time within 5 °C of Actual Peak Temperature: $T_p - 5^\circ\text{C}$	30 s
Ramp- Down Rate from Peak Temperature	6 °C /second max.
Time 25°C to peak temperature	8 minutes max.
Reflow times	3 times

## **DISCLAIMER**

1. Above specification may be changed without notice. EVERLIGHT will reserve authority on material change for above specification.
2. When using this product, please observe the absolute maximum ratings and the instructions for using outlined in these specification sheets. EVERLIGHT assumes no responsibility for any damage resulting from use of the product which does not comply with the absolute maximum ratings and the instructions included in these specification sheets.
3. These specification sheets include materials protected under copyright of EVERLIGHT corporation. Please don't reproduce or cause anyone to reproduce them without EVERLIGHT's consent.

## X-ON Electronics

Largest Supplier of Electrical and Electronic Components

*Click to view similar products for [High Speed Optocouplers](#) category:*

*Click to view products by [Everlight](#) manufacturer:*

Other Similar products are found below :

[6N136F](#) [HCPL-2201-300](#) [JAN4N24](#) [610737H](#) [HCPL2630M](#) [HCPL2630SM](#) [PS9817A-1-F3-AX](#) [PS9821-2-F3-AX](#) [TLP2766A\(E](#)  
[TLP2766A\(LF4,E](#) [PS9121-F3-AX](#) [PS9123-F3-AX](#) [TLP5774H\(TP4,E](#) [TLP5771H\(TP,E](#) [TLP2304\(E\(O](#) [054279X](#) [HCPL2631SD](#) [HCPL-2730-](#)  
[500E](#) [TLP118\(TPL,E\)](#) [TLP2309\(E\(T](#) [TLP2366\(TPL,E](#) [TLP521-2XGB](#) [TLP621-2XGB](#) [JANTXV4N24U](#) [8102802PC](#) [5962-8767902XA](#)  
[5962-8876801XA](#) [5962-8957101PA](#) [SFH6318T](#) [6N135-300E](#) [TIL198](#) [TLP104\(TPR,E\)](#) [TLP2309\(TPL,E\)](#) [TLP2355\(TPL,E](#) [TLP2358\(E\)](#)  
[TLP521-4GR](#) [TLP521-4XGB](#) [TLP621XSM](#) [5962-8876801PA](#) [IS281-4GB](#) [IS2805-4](#) [IS181GR](#) [ICPL2630](#) [ICPL2531](#) [ICPL2601](#) [ICPL2530](#)  
[TLP2301](#) [TLP2301\(E\(T](#) [TLP2362\(TPR,E](#) [FOD0710R2](#)