

ELCH08-2225J4J6283910-F0(ZTE)

Received

MASS PRODUCTION

PRELIMINARY

CUSTOMER DESIGN

DEVICE NO. : DHE-0002393

PAGE : 12

Revised record

REV.	DESCRIPTION	RELEASE DATE
1	New spec	2014.04.01
2	According to ECR*51119 Change Product Labeling	2016.02.02

ELCH08-2225J4J6283910-F0(ZTE)

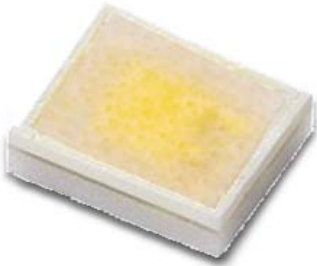

Features

- Feature of the device : small package with high efficiency
- Typical luminous flux@ 1A : 200 lm
- Optical efficiency@1A : 58.48 lm/W
- ESD protection (according to JEDEC 3b) (HBM air or contact discharge)up to 8KV
- Binning Parameters : Brightness, Forward Voltage and Chromaticity
- Grouping parameter: total luminous flux, color coordinates.
- RoHS compliant & Pb free.

Applications

- Mobile Phone Camera Flash(Camera flash light /strobe light for mobile devices)
- Torch light for DV(Digital Video) application
- Indoor lighting applications
- Signal and symbol luminaries for orientation maker lights (e.g. steps, exit ways, etc.)
- TFT backlighting
- Exterior and interior illumination applications
- Decorative and Entertainment Lighting
- Exterior and interior automotive illumination

Device Selection Guide

Chip Materials	Emitted Color
InGaN	Warm White

Absolute Maximum Ratings

Parameter	Symbol	Rating	Unit
DC Forward Current (Torch Mode)	I_F	350	mA
Peak Pulse Current (400 ms on / 3600 ms off / 30000 cycle)	I_{Pulse}	1500	mA
ESD Resistance (JEDEC 3b)	V_B	8000	V
Reverse Voltage	V_R	Note 1	V
Junction Temperature	T_J	150	°C
Operating Temperature	T_{Opr}	-40 ~ +85	°C
Storage Temperature	T_{Stg}	-40 ~ +100	°C
Soldering Temperature	T_{Sol}	260	°C
Allowable Reflow Cycles	n/a	2	Cycles
Substrate Temperature	T_s	70(IF=1000mA)	°C
Viewing Angle $_{\theta(2)}$	$2\theta_{1/2}$	120	Deg
Power Dissipation (Pulse Mode)	P_d	6.5	W

Notes:

1. The Chin series LEDs are not designed for reverse bias used.
2. View angle measurement tolerance $\pm 5^\circ$
3. Avoid operating Chin series LEDs at maximum operating temperature exceed 1 hour.
4. All specification are assured by reliability test for 1000hr, IV degradation less than 30%.
5. For 1500mA all reliability item are tested under good thermal management with 1.0 x 1.0 cm² MCPCB
6. Peak pulse current shall be applied under conditions as max duration time 50 ms and max duty cycle 10%
7. Operate LED component at maximum rating conditions continuously will cause possible permanent damage and de-rating parameters. Exercise multiple maximum rating parameters simultaneously should not be allowed. When maximum rating parameters are applied over a long period will result potential reliability issue.

JEDEC Moisture Sensitivity

Level	Floor Life		Soak Requirements Standard	
	Time (hours)	Conditions	Time (hours)	Conditions
1	Unlimited	≤ 30°C / 85% RH	168 (+5/-0)	85°C / 85% RH

Electro-Optical Characteristics (Ts=25°C)

Parameter	Symbol	Min.	Typ.	Max.	Unit	Condition
Luminous Flux ₍₁₎	I _v	160	200	----	lm	
Forward Voltage ₍₂₎₍₃₎	V _F	2.85	----	3.95	V	I _F =1000mA
Color Temperature	CCT	2200	----	2500	K	

Forward Voltage Binning

Bin	Symbol	Min.	Typ.	Max.	Unit	Condition
2832	V _F	2.85	----	3.25	V	I _F =1000mA
3235	V _F	3.25	----	3.55		
3539	V _F	3.55	----	3.95		

Luminous Flux Binning

Bin	Symbol	Min.	Typ.	Max.	Unit	Condition
J4	I _v	160	----	180	lm	I _F =1000mA
J5	I _v	180	----	200		
J6	I _v	200	----	250		

Notes:

1. Luminous Flux, illuminance measurement tolerance : ±10%
2. Forward voltage measurement tolerance : ±0.1V
3. Electric and optical data is tested at 50 ms pulse condition.
4. Temperature of solder pad : 25°C

White Bin Structure

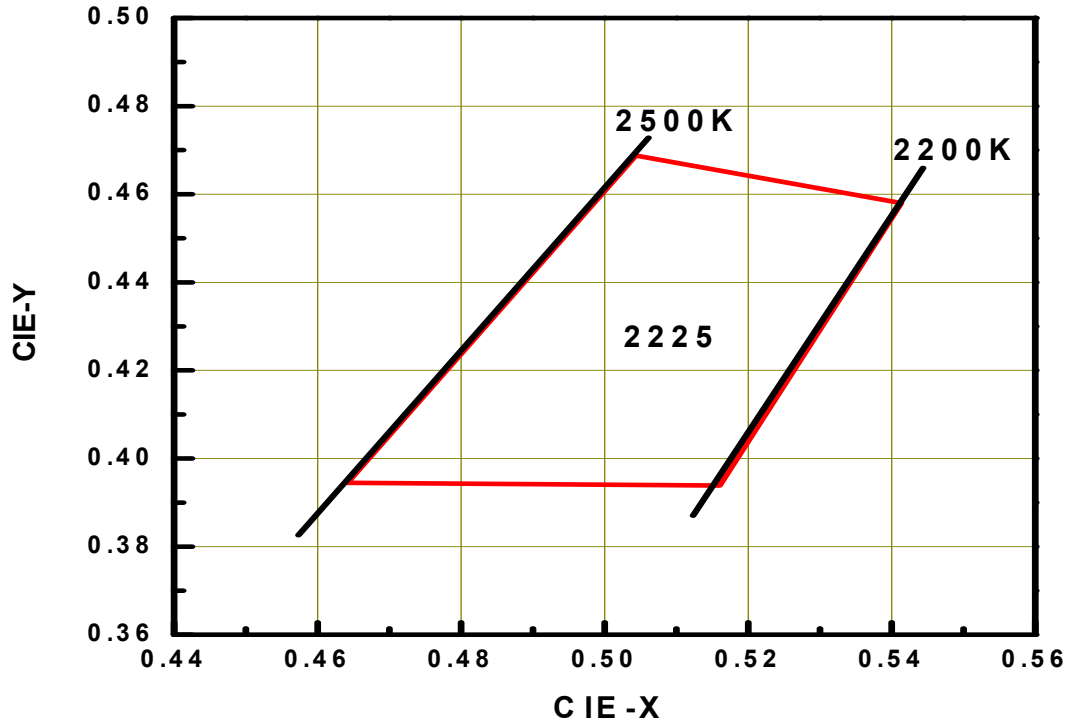

Bin	CIE-X	CIE-Y	Reference Range
2225	0.4641	0.3945	2200 K ~ 2500 K
	0.5043	0.4688	
	0.5413	0.4580	
	0.5160	0.3939	

Notes:

1. Color coordinates measurement allowance : ± 0.01
2. Color bins are defined at IF=1000mA operation.

Typical Electro-Optical Characteristics Curves

Relative Spectral Distribution , $I_F=1000\text{mA}$ @ 50ms , $T_{\text{solder pad}}=25^\circ\text{C}$

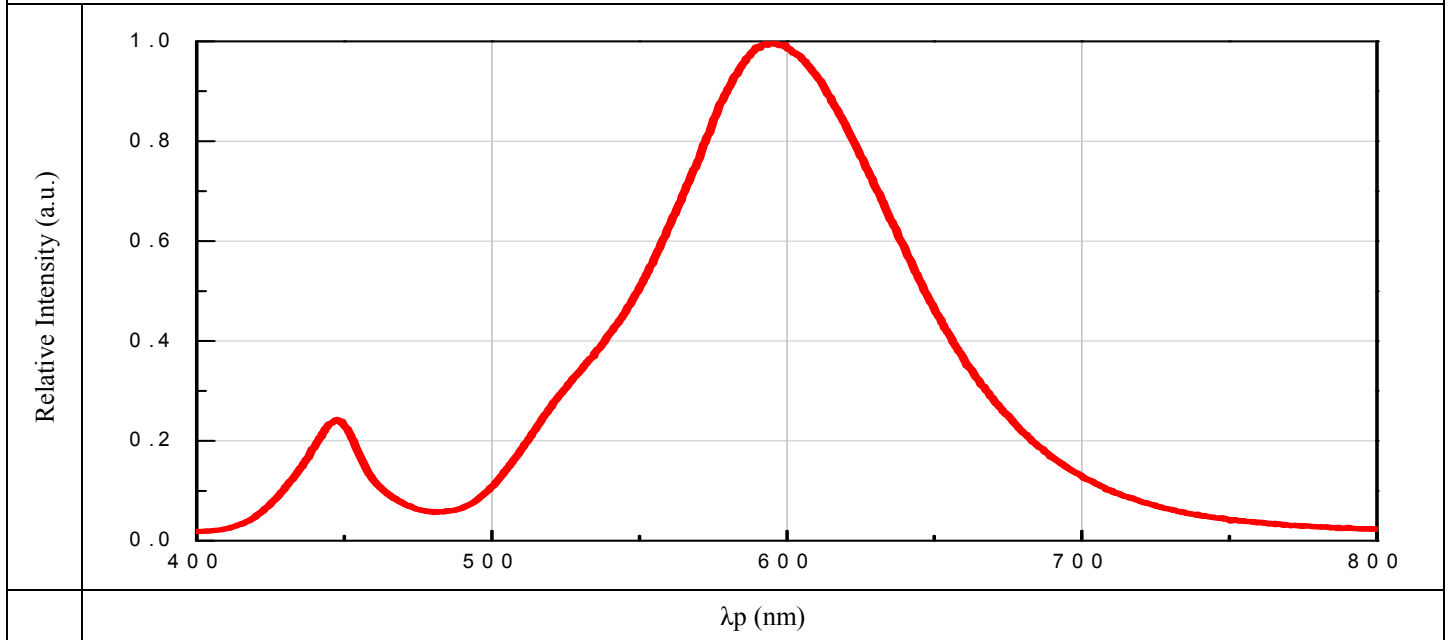

Typical Radiation Patterns

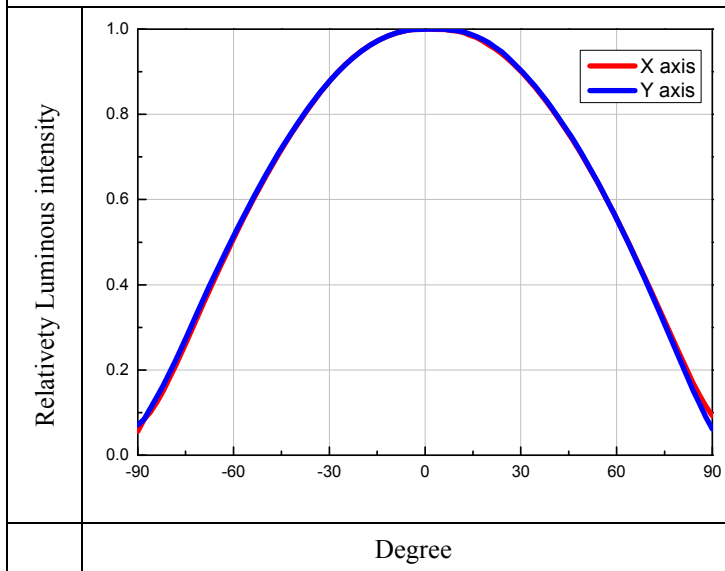

Typical Polar Radiation Pattern for Lambertian

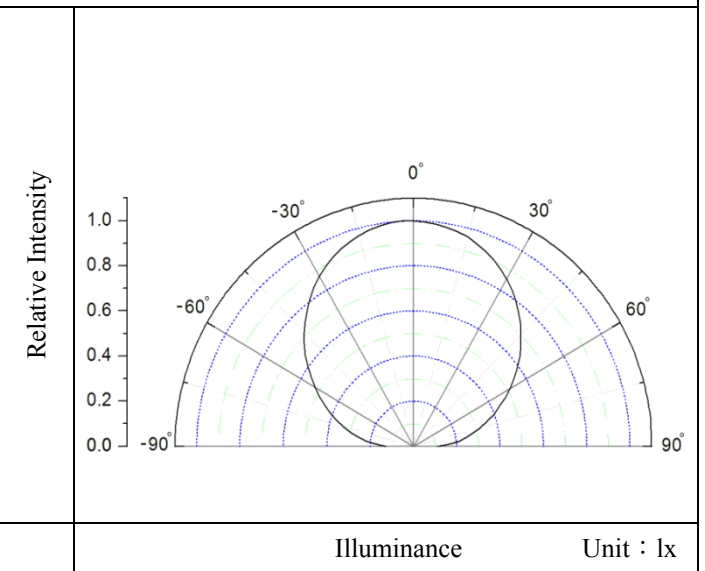

Notes:

1. $2\theta_{1/2}$ is the off axis from lamp centerline where the luminous intensity is 1/2 of the peak value.
2. View angle tolerance is $\pm 5^\circ$

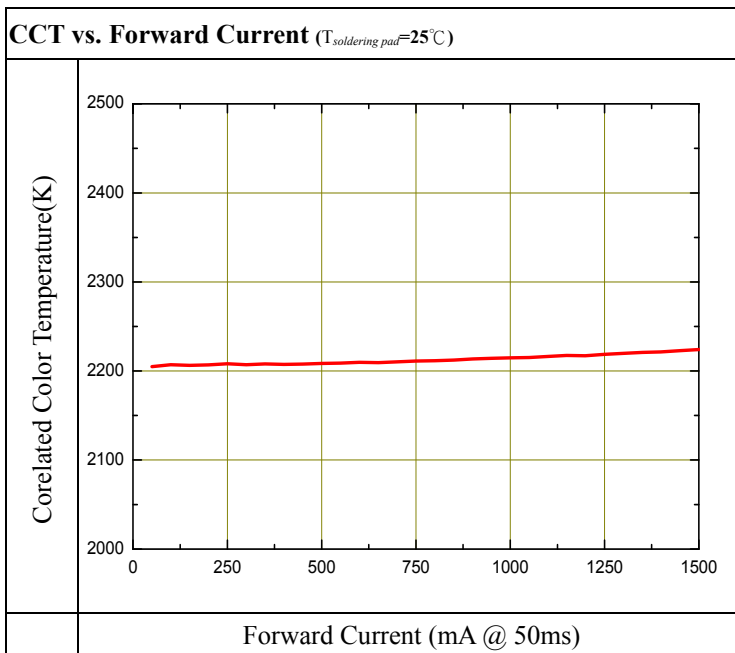
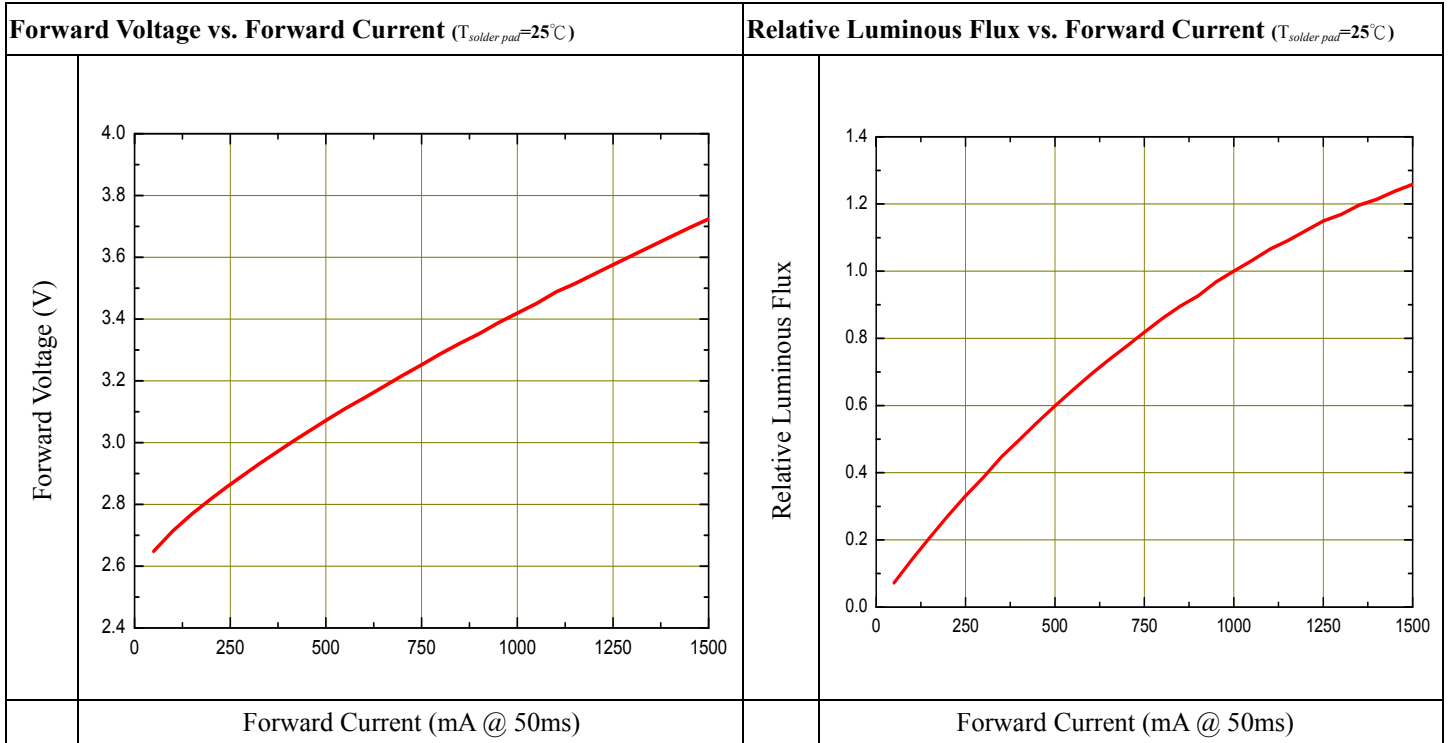

Notes:

- All correlation data is tested under superior thermal management with 1 x 1 cm² MCPCB.

Package Dimension

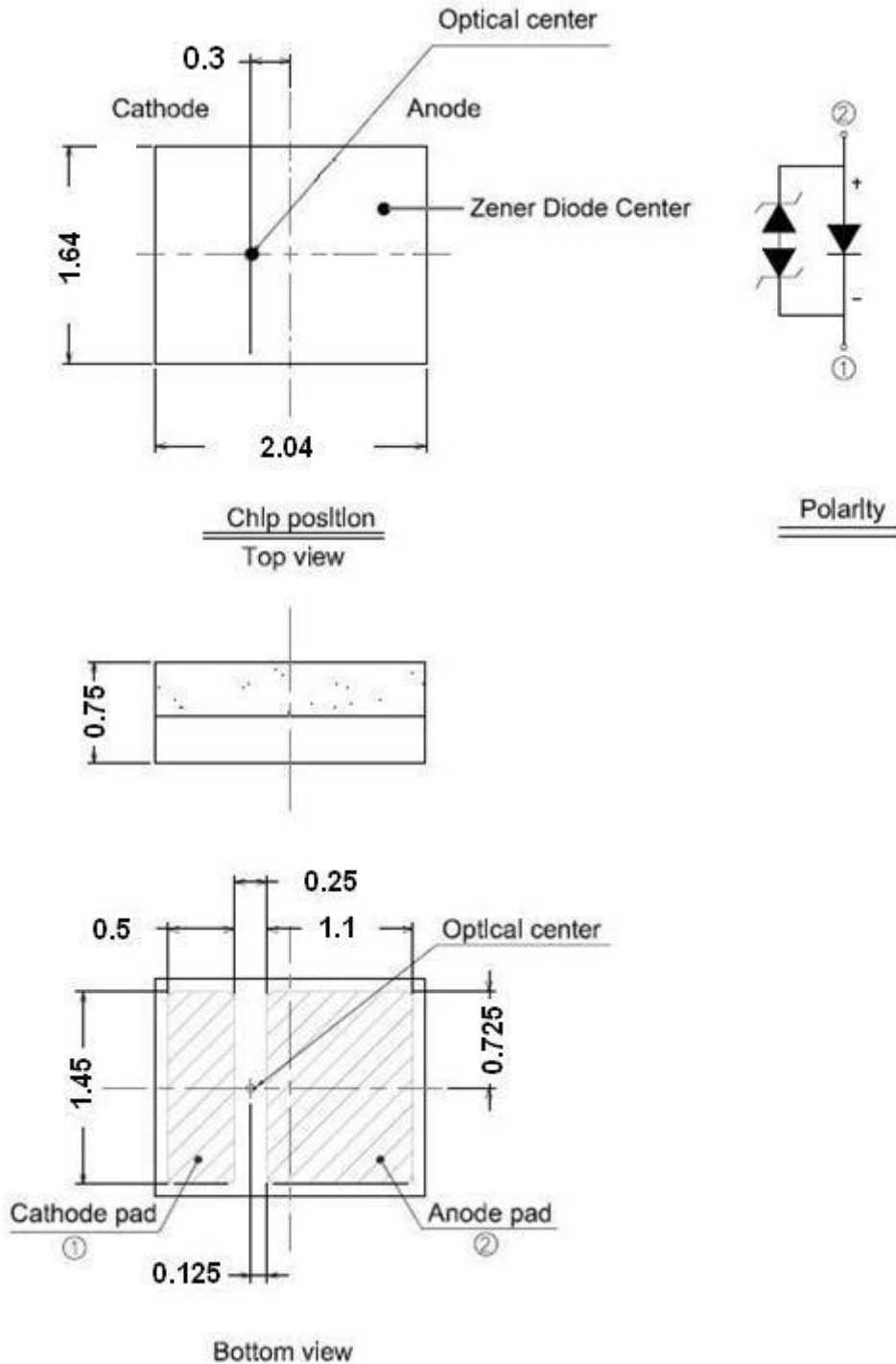

Notes:

1. Dimensions are in millimeters.
2. Tolerances unless mentioned are ± 0.1 mm.

Moisture Resistant Packing Materials

Product Labeling

EVERLIGHT 12

CPN: 013040100007
P/N: 35GV013918 D/C: Y151225

19-213/GVC-AMNB/3T (ZTE)

QTY: 2000 CAT: M
HUE: C14
REF: 1

LOT NO: Y151225XXXXXX

REFERENCE: BTP151225XXXXX

MADE IN TAIWAN

- CPN: Customer Specification (when required)
- P/N: Everlight Production Number
- QTY: Packing Quantity
- CAT: Luminous Flux (Brightness) Bin
- HUE: Color Bin
- REF: Forward Voltage Bin
- LOT No: Lot Number
- REFERENCE: Reference

Carrier Tape Dimensions: Loaded Quantity 2000 pcs Per Reel

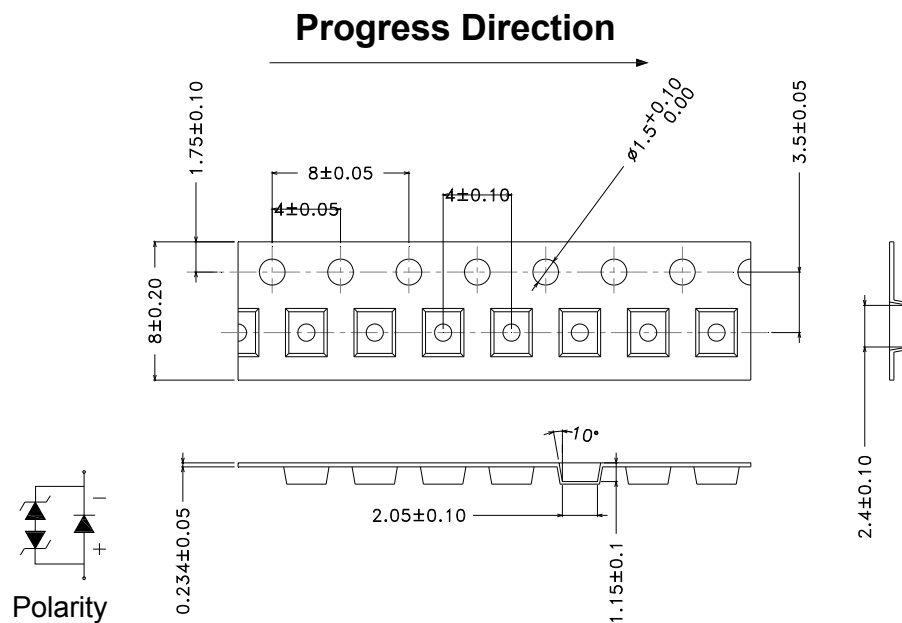

Notes:

1. Dimensions are in millimeters.
2. Tolerances for fixed dimensions are ± 0.1 mm.

Emitter Reel Dimensions

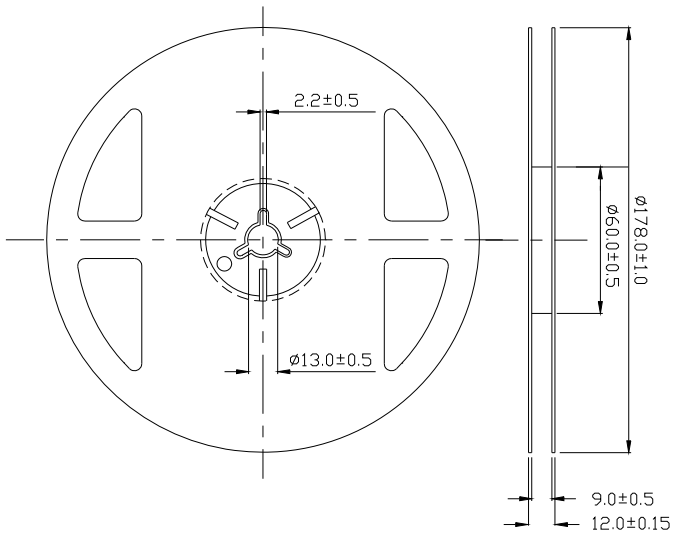

Notes:

1. Dimensions are in millimeters.

Moisture Resistant Packing Process

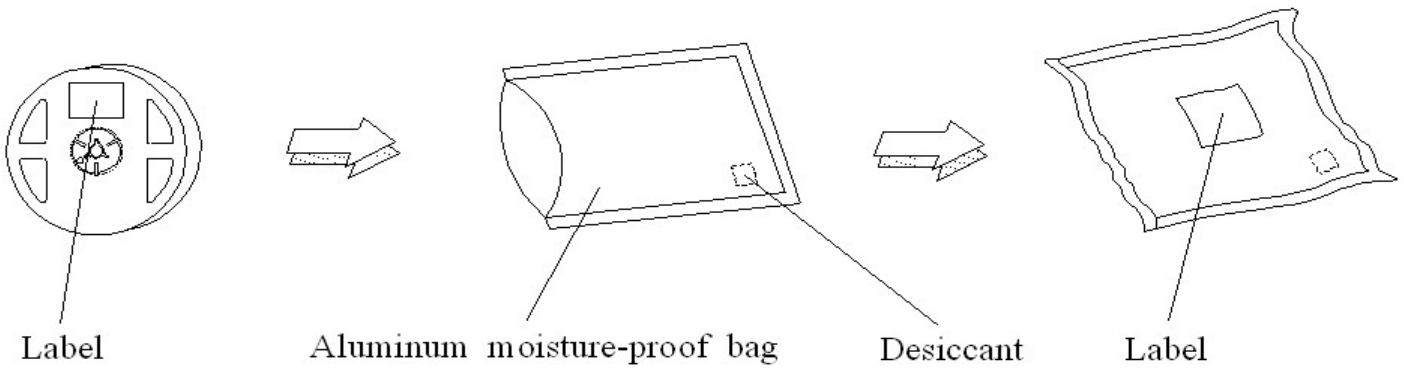

Notes:

Reflow Soldering Characteristics

Soldering and Handling

1. Over-current-proof

Though CHIN series has conducted ESD protection mechanism, customers must not use the device in reverse and should apply resistors for extra protection. Otherwise, slight voltage shift may cause enormous current shift and burn out failure would happen.

2. Storage

- 2.1 Do not open the moisture proof bag before the products are ready to use.
- 2.2 Before opening the package, the LEDs should be stored at temperature less than 30°C and relative humidity less than 90%
- 2.3 After opening the package, the LEDs should be stored at temperature less than 30°C and relative humidity less than 85%.
- 2.4 If the moisture absorbent material (silicone gel) has faded away or the LEDs have exceeded the storage time, baking treatment should be implemented based on the following conditions: Pre-curing at 60±5°C for 24 hours.

3. Thermal Management

- 3.1 For maintaining the high flux output and achieving reliability, CHIN series LEDs should be mounted on a metal core printed circuit board (MCPCB), with proper thermal connection to dissipate approximately 1W to 5W of thermal energy under normal operation.
- 3.2 Sufficient thermal management must be conducted, or the die junction temperature will be over the limit under large electronic driving and LEDs lifetime will decrease critically.
- 3.3 When operating, the solder pad temperature (or the board temperature nearby the LED) must controlled under 70°C.

4. Soldering Condition

4.1 Soldering Pad

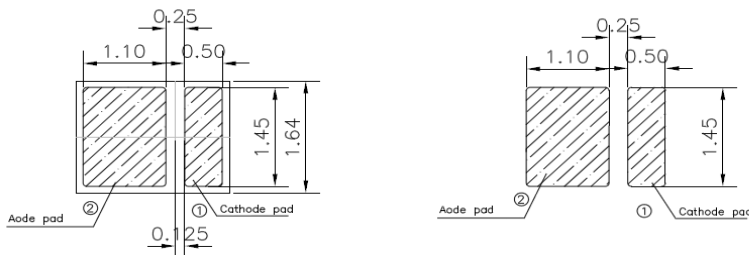

Component bottom view

Recommended soldering pattern layout

4.2 For Reflow Process

4.2.1 Lead reflow soldering temperature profile

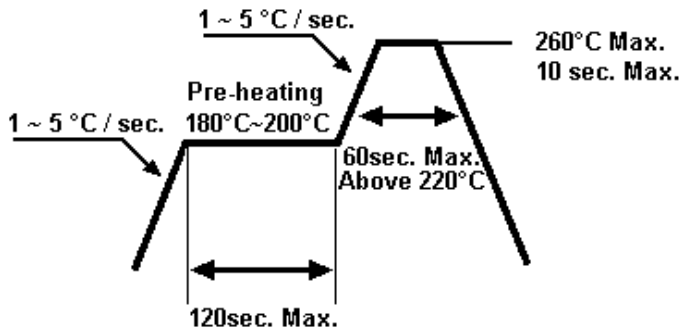

4.2.2 Reflow soldering should not be done more than two times.

4.2.3 While soldering, do not put stress on the LEDs during heating.

4.2.4 After soldering, do not warp the circuit board.

X-ON Electronics

Largest Supplier of Electrical and Electronic Components

Click to view similar products for [Standard LEDs - SMD category](#):

Click to view products by [Everlight manufacturer](#):

Other Similar products are found below :

[LTST-C190KYKT](#) [LTST-C19GD2WT](#) [LTST-N683GBEW](#) [LTW-170ZDC](#) [LTW-M140SZS40](#) [598-8110-100F](#) [598-8170-100F](#) [598-8610-202F](#) [AAAF5060QBFSEEZGS](#) [HLMA-QG00-S0021](#) [ALMD-LB36-SV002](#) [APT1608QGW](#) [EAST2012YA0](#) [EASV1803BA0](#) [LG M67K-H1J2-24-0-2-R18-Z](#) [SML-512VWT86A](#) [SML-LX0606SISUGC/A](#) [SML-LXL1307SRC-TR](#) [SML-LXR851SIUPGUBC](#) [LT1ED53A](#) [AM27ZGC03](#) [APB3025SGNC](#) [APFA3010SURKCGKQBDC](#) [APHK1608VGCA](#) [CLX6D-FKB-CN1R1H1BB7D3D3](#) [LTST-008BGEW](#) [LTST-C250KGKT](#) [LTW-010DCG](#) [LTW-020ZDCG](#) [LTW-21TS5](#) [LTW-220DS5](#) [598-8330-117F](#) [SML-LX0402IC-TR](#) [CMDA20AYAA7D1S](#) [CMDA16AYDR7A1X](#) [91-21SYGD/S530-E2/TR7](#) [HSMQ-C177](#) [598-8040-100F](#) [598-8070-100F](#) [598-8140-100F](#) [598-8610-200F](#) [EAST2012GA0](#) [EAPL3527GA5](#) [SML-LXL1209SYC/ATR](#) [EAST2012RA0](#) [EAST1608RGBAA0](#) [CMD91-21VRC/TR7](#) [SML-LXR851SGSIC-TR](#) [SML-512PWT86A](#) [SMF-2432GYC-TR](#)