

## 5 PIN SOP HIGH SPEED 1Mbit/s TRANSISTOR PHOTOCOUPLER ELM45X series

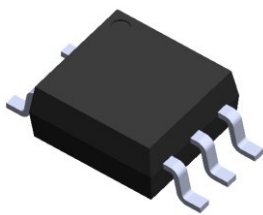

### Features

- Compliance Halogen Free .  
(Br <900 ppm , Cl <900 ppm , Br+Cl < 1500 ppm)
- High speed 1Mbit/s
- High isolation voltage between input and output (Viso=3750 Vrms )
- High CMR 15KV/us at  $V_{CM}=1500V$  (ELM453)
- Guaranteed performance from 0°C to 70°C
- Wide operating temperature range of -40°C to 85°C
- Compliance with EU REACH
- Pb free and RoHS compliant
- UL and cUL approved(No. E214129)
- VDE approved (No. 40028116)
- SEMKO approved
- NEMKO approved
- DEMKO approved
- FIMKO approved

### Description

The ELM452 and ELM453 devices each consist of an infrared emitting diode, optically coupled to a high speed photo detector transistor. A separate connection for the photodiode bias and output-transistor collector increase the speed by several orders of magnitude over conventional phototransistor couplers by reducing the base-collector capacitance of the input transistor. The devices are packaged in industry standard 5pin SOP packages and are suitable for surface mounting.

### Applications

- Line receivers
- Field bus communication and control.
- Power transistor isolation in motor drives
- Replacement for low speed phototransistor photo couplers
- High speed logic ground isolation
- Analog signal ground isolation

### Schematic

#### ELM45X series

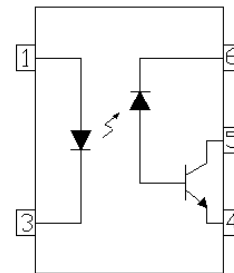

### Pin Configuration

1. Anode
3. Cathode
4. Gnd
5. Vout
6. VCC

**Absolute Maximum Ratings (Ta=25°C unless otherwise noted)**

	Parameter	Symbol	Rating	Unit
Input	Forward current	$I_F$	25	mA
	Peak forward current (50% duty, 1ms P.W)	$I_{FP}$	50	mA
	Peak transient current ( $\leq 1\mu s$ P.W, 300pps)	$I_{Ftrans}$	1	A
	Reverse voltage	$V_R$	5	V
	Power dissipation	$P_{IN}$	45	mW
Output	Power dissipation	$P_O$	100	mW
	Average Output current	$I_{O(AVG)}$	8	mA
	Peak Output current	$I_{O(PK)}$	16	mA
	Output voltage	$V_O$	-0.5 to 20	V
	Supply voltage	$V_{CC}$	-0.5 to 30	V
	Isolation voltage <sup>*1</sup>	$V_{ISO}$	3750	V rms
	Operating temperature	$T_{OPR}$	-40 ~ +85	°C
Storage temperature	$T_{STG}$	-55 ~ +125	°C	
Soldering temperature <sup>*2</sup>	$T_{SOL}$	260	°C	

Notes:

\*1 AC for 1 minute, R.H.= 40 ~ 60% R.H. In this test, pins 1 & 3 are shorted together, and pins 4, 5 & 6 are shorted together.

\*2 For 10 seconds.

**Electrical Characteristics (T<sub>A</sub>=0 to 70°C unless specified otherwise)**

**Input**

Parameter	Symbol	Min.	Typ.	Max.	Unit	Condition
Forward Voltage	V <sub>F</sub>	-	1.45	1.8	V	I <sub>F</sub> = 16mA
Reverse Voltage	V <sub>R</sub>	5.0	-	-	V	I <sub>R</sub> = 10μA
Temperature coefficient of forward voltage	ΔV <sub>F</sub> /ΔT <sub>A</sub>	-	-1.6	-	mV/°C	I <sub>F</sub> = 16mA

**Output**

Parameter	Symbol	Min	Typ.	Max.	Unit	Condition
Logic High Output Current	I <sub>OH</sub>	-	0.001	0.5	μA	I <sub>F</sub> =0mA, V <sub>O</sub> =V <sub>CC</sub> =5.5V, T <sub>A</sub> =25°C
		-	0.001	1		I <sub>F</sub> =0mA, V <sub>O</sub> =V <sub>CC</sub> =15V, T <sub>A</sub> =25°C
		-	-	50		I <sub>F</sub> =0mA, V <sub>O</sub> =V <sub>CC</sub> =15V
Logic Low Supply Current	I <sub>CCL</sub>	-	100	200	μA	I <sub>F</sub> =16mA, V <sub>O</sub> =Open, V <sub>CC</sub> =15V
Logic High Supply Current	I <sub>CCH</sub>	-	0.05	1	μA	I <sub>F</sub> =0mA, V <sub>O</sub> =Open, V <sub>CC</sub> =15V, T <sub>A</sub> =25°C
		-	-	2		I <sub>F</sub> =0mA, V <sub>O</sub> =Open, V <sub>CC</sub> =15V

**Transfer Characteristics**

Parameter	Symbol	Min	Typ.	Max.	Unit	Condition
Current Transfer Ratio	CTR	20	-	50	%	I <sub>F</sub> = 16mA, V <sub>O</sub> = 0.4V, V <sub>CC</sub> =4.5V, T <sub>A</sub> =25°C
		15	-	-		I <sub>F</sub> = 16mA, V <sub>O</sub> = 0.5V, V <sub>CC</sub> =4.5V
Logic Low Output Voltage	V <sub>OL</sub>	-	-	0.4	V	I <sub>F</sub> = 16mA, I <sub>O</sub> = 3mA, V <sub>CC</sub> =4.5V, T <sub>A</sub> =25°C
		-	-	0.5		I <sub>F</sub> = 16mA, I <sub>O</sub> = 2.4mA, V <sub>CC</sub> =4.5V

Switching Characteristics ( $T_A=0$  to  $70^{\circ}\text{C}$  unless specified otherwise,  $V_{CC}=5\text{V}$ )

Parameter	Symbol	Min	Typ.	Max.	Unit	Condition
Propagation Delay Time to Logic Low <sup>(*)</sup> (Fig.8)	$T_{PHL}$	-	0.4	0.8	$\mu\text{s}$	$I_F=16\text{mA}$ , $R_L=1.9\text{K}\Omega$ , $T_A=25^{\circ}\text{C}$
		-	-	1.0		$I_F=16\text{mA}$ , $R_L=1.9\text{K}\Omega$
Propagation Delay Time to Logic High <sup>(*)</sup> (Fig.8)	$T_{PLH}$	-	0.35	0.8	$\mu\text{s}$	$I_F=16\text{mA}$ , $R_L=1.9\text{K}\Omega$ , $T_A=25^{\circ}\text{C}$
		-	-	1.0		$I_F=16\text{mA}$ , $R_L=1.9\text{K}\Omega$
Common Mode Transient Immunity at Logic High <sup>(*)</sup> (Fig.9)	ELM452	5,000	-	-	$\text{V}/\mu\text{s}$	$I_F = 0\text{mA}$ , $V_{CM}=10\text{Vp-p}$ , $R_L=1.9\text{K}\Omega$ , $T_A =25^{\circ}\text{C}$
	ELM453	15,000	-	-		$I_F = 0\text{mA}$ , $V_{CM}=1500\text{Vp-p}$ , $R_L=1.9\text{K}\Omega$ , $T_A =25^{\circ}\text{C}$
Common Mode Transient Immunity at Logic Low <sup>(*)</sup> (Fig.9) <sub>3</sub>	ELM452	5,000	-	-	$\text{V}/\mu\text{s}$	$I_F = 16\text{mA}$ , $V_{CM}=10\text{Vp-p}$ , $R_L=1.9\text{K}\Omega$ , $T_A =25^{\circ}\text{C}$
	ELM453	15,000	-	-		$I_F = 16\text{mA}$ , $V_{CM}=1500\text{Vp-p}$ , $R_L=1.9\text{K}\Omega$ , $T_A =25^{\circ}\text{C}$

\* Typical values at  $T_a = 25^{\circ}\text{C}$

Typical Electro-Optical Characteristics Curves

Figure 1. Forward Current vs Forward Voltage

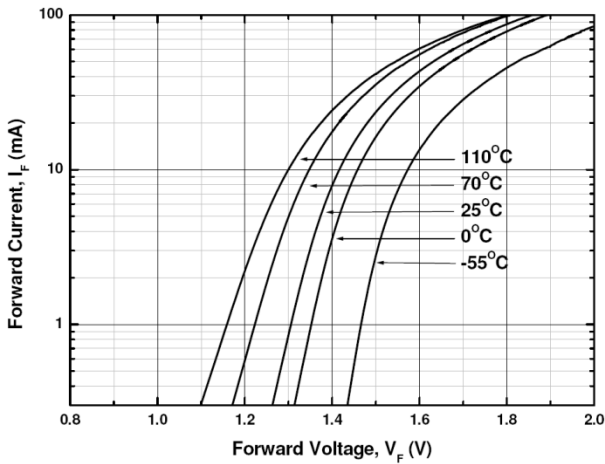

Figure 2. Current Transfer Ratio vs Forward Current

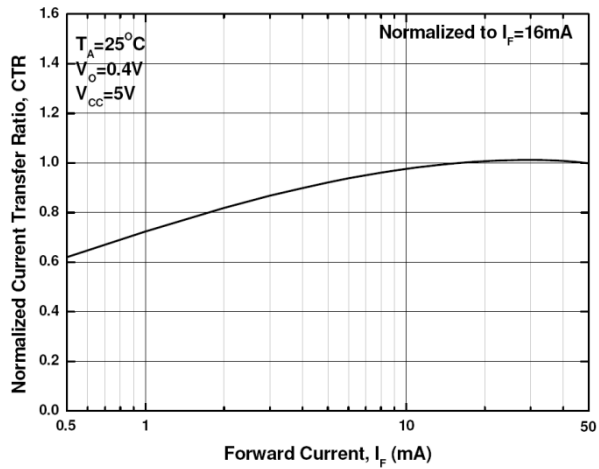

Figure 3. Current Transfer Ratio vs Ambient Temperature

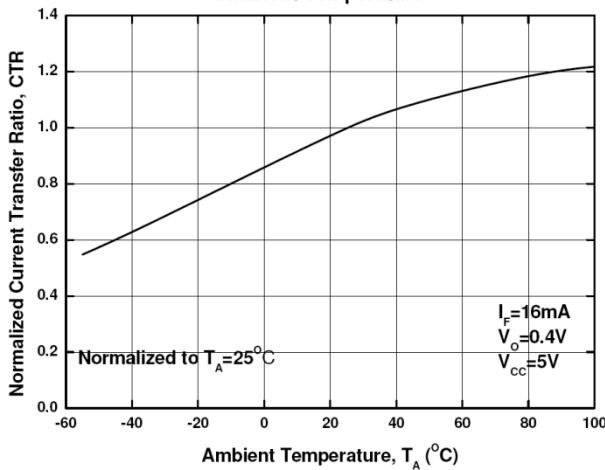

Figure 4. Output Current vs Output Voltage

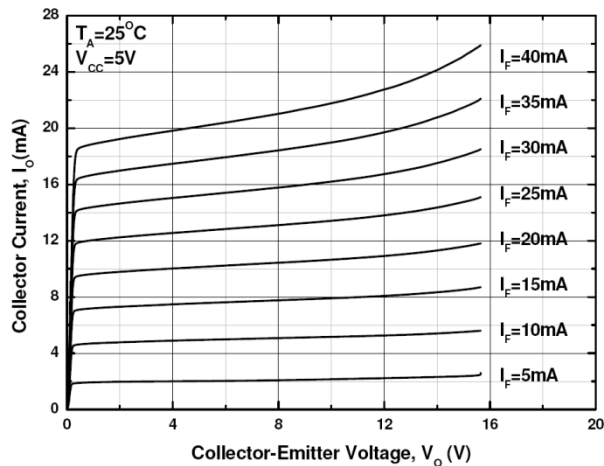

Figure 5. Logic High Output Current vs Ambient Temperature

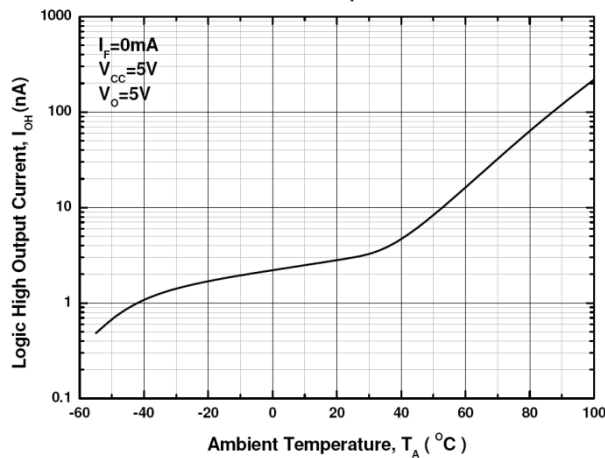

Figure 6. Propagation Delay vs. Load Resistance

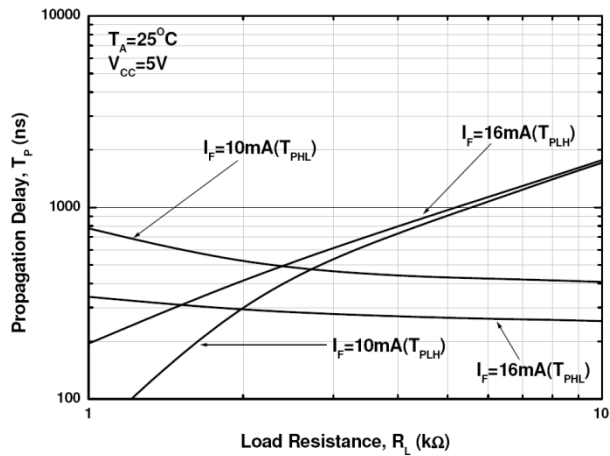

Figure 7. Propagation Delay vs. Temperature

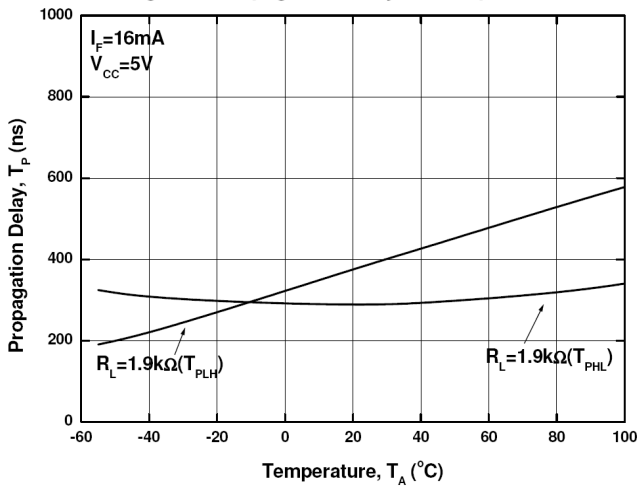

Figure 8. Frequency Response

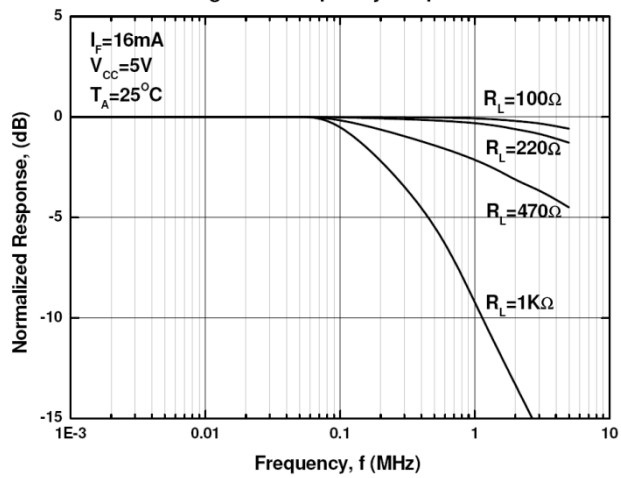

Figure 9 Switching Time Test Circuit & Waveform

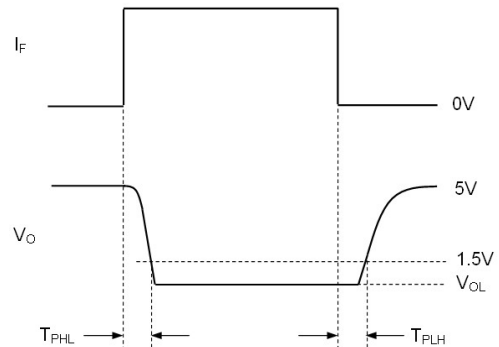
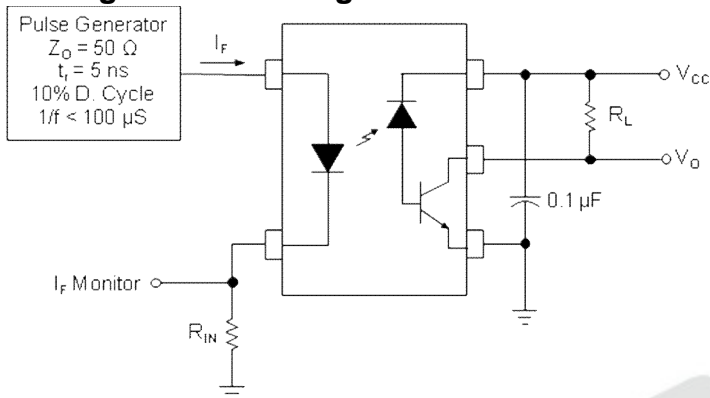
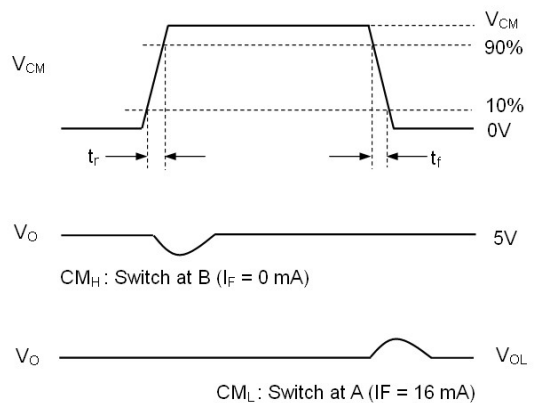
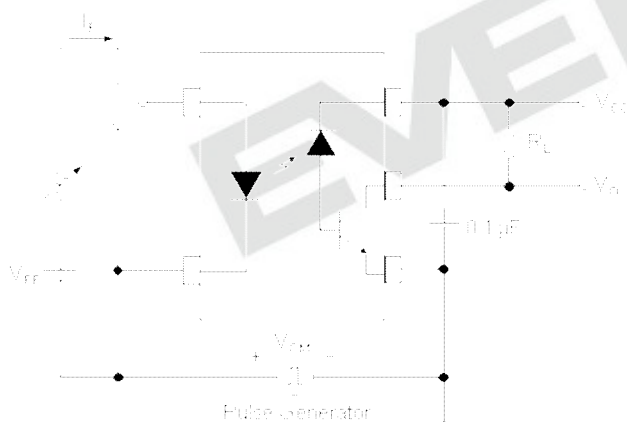

Figure 10 Transient Immunity Test Circuit & Waveform



**Note:**

\*3 Common mode transient immunity in logic high level is the maximum tolerable (positive)  $dV_{CM}/dt$  on the leading edge of the common mode pulse signal  $V_{CM}$ , to assure that the output will remain in a logic high state (i.e.,  $V_O > 2.0V$ ).

Common mode transient immunity in logic low level is the maximum tolerable (negative)  $dV_{CM}/dt$  on the trailing edge of the common mode pulse signal,  $V_{CM}$ , to assure that the output will remain in a logic low state (i.e.,  $V_O < 0.8V$ ).

## Order Information

### Part Number

**ELM45X(Z)-V**

### Note

- X = Part No. (2 or 3)
- Z = Tape and reel option (TA, TB or none)
- V = VDE (optional)

Option	Description	Packing quantity
None	Standard	100 units per tube
-V	Standard + VDE	100 units per tube
(TA)	TA tape & reel option	3000 units per reel
(TB)	TB tape & reel option	3000 units per reel
(TA)-V	TA tape & reel option + VDE	3000 units per reel
(TB)-V	TB tape & reel option + VDE	3000 units per reel

EVERLIGHT

**Package Dimension**  
(Dimensions in mm)

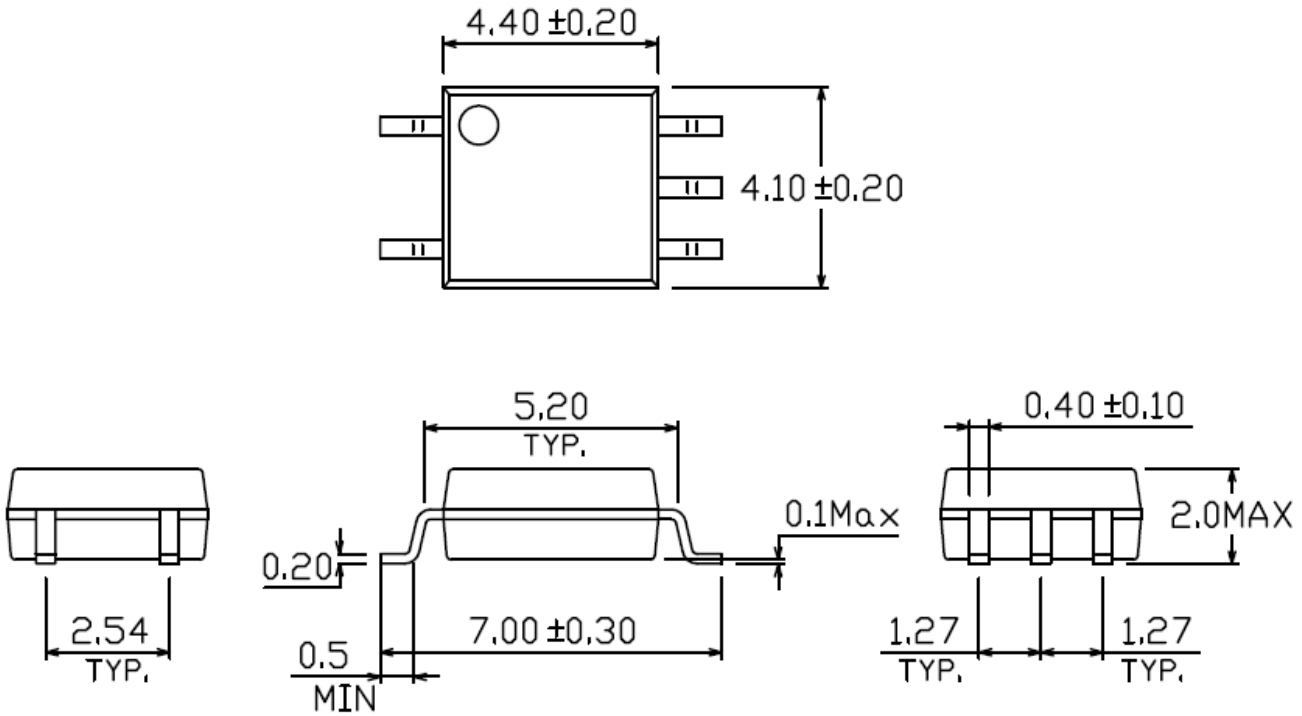

**Recommended pad layout for surface mount leadform**

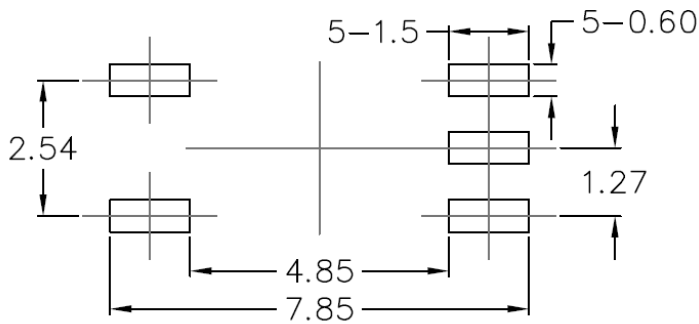



## Device Marking



## Notes

EL	denotes EVERLIGHT
M453	denotes Device Number
Y	denotes 1 digit Year code
WW	denotes 2 digit Week code
V	denotes VDE (optional)

EVERLIGHT

**Tape & Reel Packing Specifications**

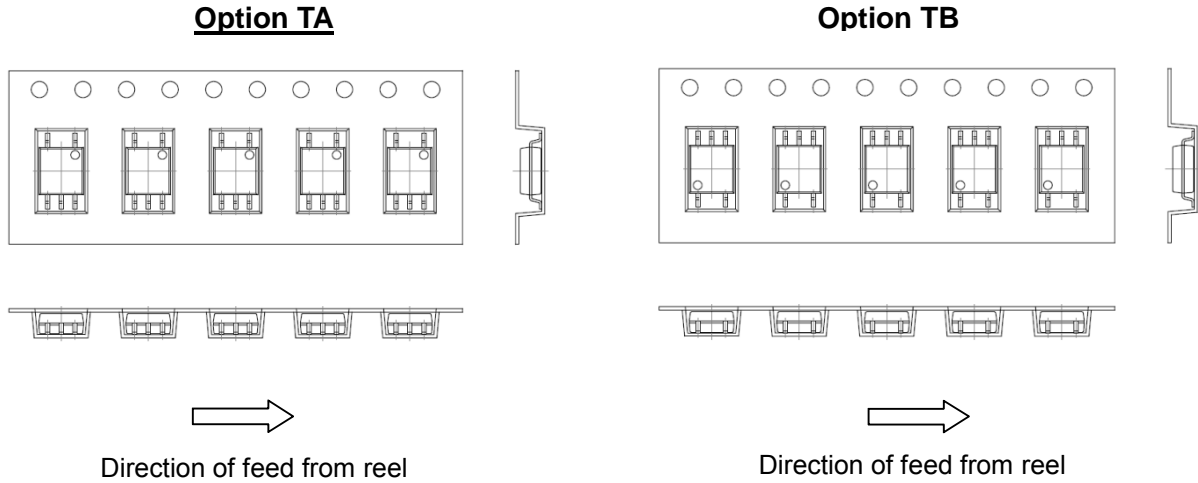

**Tape dimensions**

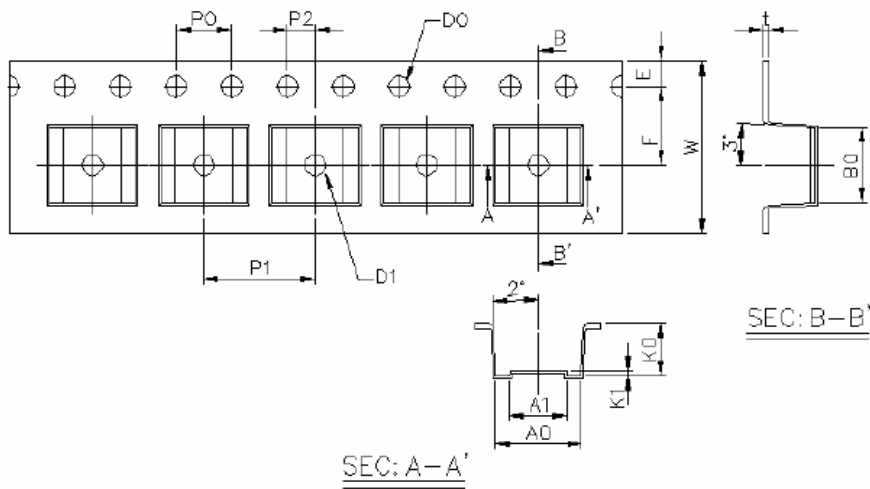

Dimension No.	<b>A0</b>	<b>A1</b>	<b>B0</b>	<b>D0</b>	<b>D1</b>	<b>E</b>	<b>F</b>
Dimension(mm)	6.2±0.1	4.1±0.1	5.28±0.1	1.5±0.1	1.5±0.3	1.75±0.1	5.5±0.1
Dimension No.	<b>Po</b>	<b>P1</b>	<b>P2</b>	<b>t</b>	<b>W</b>	<b>K0</b>	<b>K1</b>
Dimension(mm)	4.0±0.1	8.0±0.1	2.0±0.1	0.4±0.1	12.0+0.3/ -0.1	3.7±0.1	0.3±0.1

**Precautions for Use**

1. Soldering Condition

1.1 (A) Maximum Body Case Temperature Profile for evaluation of Reflow Profile

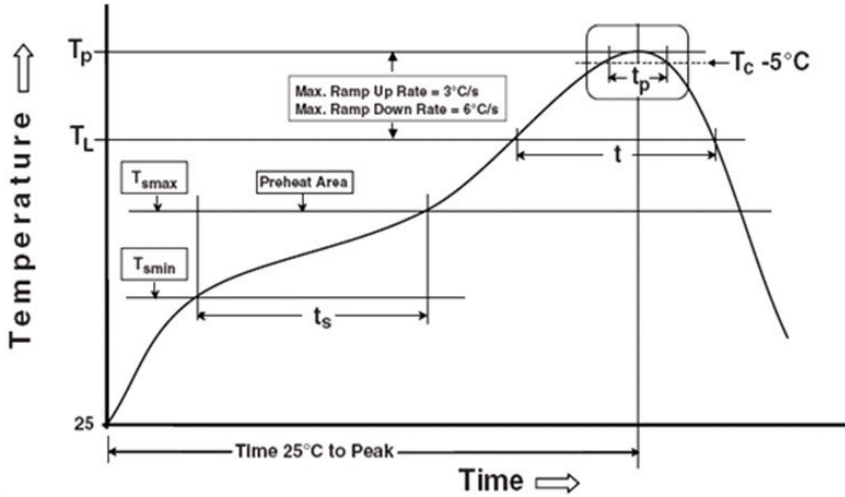

Note:

Reference: IPC/JEDEC J-STD-020D

**Preheat**

Temperature min ( $T_{smin}$ )	150 °C
Temperature max ( $T_{smax}$ )	200°C
Time ( $T_{smin}$ to $T_{smax}$ ) ( $t_s$ )	60-120 seconds
Average ramp-up rate ( $T_{smax}$ to $T_p$ )	3 °C/second max

**Other**

Liquidus Temperature ( $T_L$ )	217 °C
Time above Liquidus Temperature ( $t_L$ )	60-100 sec
Peak Temperature ( $T_p$ )	260°C
Time within 5 °C of Actual Peak Temperature: $T_p - 5^\circ\text{C}$	30 s
Ramp- Down Rate from Peak Temperature	6°C /second max.
Time 25°C to peak temperature	8 minutes max.
Reflow times	3 times

## DISCLAIMER

1. Above specification may be changed without notice. EVERLIGHT will reserve authority on material change for above specification.
2. When using this product, please observe the absolute maximum ratings and the instructions for using outlined in these specification sheets. EVERLIGHT assumes no responsibility for any damage resulting from use of the product which does not comply with the absolute maximum ratings and the instructions included in these specification sheets.
3. These specification sheets include materials protected under copyright of EVERLIGHT corporation. Please don't reproduce or cause anyone to reproduce them without EVERLIGHT's consent.

EVERLIGHT

## X-ON Electronics

Largest Supplier of Electrical and Electronic Components

*Click to view similar products for [Photodiode Output Optocouplers](#) category:*

*Click to view products by [Everlight](#) manufacturer:*

Other Similar products are found below :

[TLP590B\(C,F\)](#) [TLP7820\(A-LF4.E\(O](#) [LTV-244-GB-G](#) [LTV2301GB-V-G](#) [EL816S1\(C\)\(TU\)](#) [EL817S1\(C\)\(TU\)-VG](#) [GX357NC](#) [PC817B](#)  
[PC817C](#) [LTV-341W-TA1-H](#) [LTV-176G](#) [LTV-1003-TP1-G](#) [LTV-247-G-RT](#) [PC817B-MS](#) [FOC-817C-F](#) [CYPS2501-1\(K\)](#)  
[CYTLP2362\(TPD2\)](#) [OR-3H7C-TP-G-\(GK\)](#) [ORPC-817MC-F](#) [ORPC-817D-C](#) [ORPC-817SB-TP-F](#) [PS2801C-4-F3-A/M](#) [PC817B](#)  
[TLP183\(YH-TPL,E\(T](#) [TLP183\(GRH-TPL,E\(T](#) [TLP183\(TPL,E\(T](#) [TLP291\(BL-TP,SE\(T](#) [TLP184\(V4GBTL,SE\(T](#) [TLP785\(BLL-TP6,F\(C](#)  
[TLP293\(GRH-TPL,E\(T](#) [TLP383\(D4GL-TR,E](#) [TLP185\(BLL-TL,SE\(T](#) [TLP2309\(TPL,E\(O](#) [TLP785\(BL-TP6,F\(C](#) [TLP185\(GRL-TL,SE\(T](#)  
[TLP785\(GR-TP6,F\(C](#) [TLP183\(BL-TPL,E\(T](#) [TLP2398\(TPL,E\(T](#) [TLP127GB-S](#) [LTV-354T-A\(UMW\)](#) [6N136S\(UMW\)](#) [PC817B-S](#) [FOC-817C](#)  
[EL1018](#) [IS121A](#) [IS2701-1A](#) [IS3H7A](#) [IS121D](#) [IS2701-1C](#) [IS121GB](#)