

Shwo(D) 1W Series

爍(D)

“Shwo(D) [Shuo (D)] is the English translation for the Chinese word meaning Twinkle and is often used as a description of stars or other bright, celestial objects as seen from Earth. This word is a relevant description for this bright, compact Everlight LED package.”



Introduction

The Shwo(D) series is a surface-mount high-power device featuring high brightness combined with a compact size that is suitable for all kinds of lighting applications such as general illumination, flash, spot, signal, industrial and commercial lighting. The Shwo(D) series is one of the most promising devices in Everlight's high power product

offering and is ready to face the challenges of today's Solid-State Lighting requirements.

Features

- ◆ Small package with high efficiency
- ◆ ESD protection up to 8KV
- ◆ Soldering method: SMT
- ◆ Binning Parameters: Brightness, Forward Voltage ,Wavelength and Chromaticity
- ◆ Moisture Sensitivity Level: 1
- ◆ RoHS compliant
- ◆ Matches ANSI binning
- ◆ Reliability testing conforms to IESNA LM80 Lumen maintenance test method

Applications

- ◆ General Lighting
- ◆ Decorative and Entertainment Lighting
- ◆ Signal and Symbol Luminaries for orientation marker lights (e.g. steps, exit ways, etc.)
- ◆ Agriculture Lighting

Table of Contents

Absolute Maximum Ratings.....	4
JEDEC Moisture Sensitivity.....	4
Luminous Flux Characteristics for the Shwo(D) series.....	5
Standard PN of the Shwo(D) series: White LEDs.....	6
High Performance PN of the Shwo(D) series: White LEDs	7
Product Binning	9
Optical Characteristics	16
Mechanical Dimension	17
Pad Configuration	18
Reflow Soldering Characteristics	19
Wavelength Characteristics.....	20
Typical Light Output Characteristic V.S. Thermal Pad Temperature	22
Typical Electrical Characteristics.....	23
Typical Relative Luminous Flux V.S. Forward Current	23
Relative Flux and Forward Voltage V.S. Junction Temperature.....	26
Current Derating Curves	27
Typical Radiation Patterns.....	28
Emitter Tape Packaging	29
Emitter Reel Packaging.....	30
Product Labeling	30
Storage Conditions.....	31
Revision History	32

Product Nomenclature

The product name is designated as below:

ELSWD – ABCDE – FGHIJ – V1234

Designation:

AB = min. luminous flux (lm) or radiation power (mW) performance

C = radiation pattern ^[1]

D = color ^[2]

E = power consumption ^[3]

F = reserved for future product offerings

G = Internal code

H = packaging type ^[4]

IJ = internal code

V = forward voltage bin

1234 = color bin or CCT bin

Notes

1. Table of radiation patterns

Symbol	Description
1	Lambertian

2. Table of color offerings:

Symbol	Color	Dominant wavelength range
R	Red	620~630nm
O	Orange	610~620nm
Y	Amber	585~595nm
G	Green	520~535nm
B	Blue	460~470nm
C	Cool-White	4745~7050K
N	Neutral-White	3710~4745K
M	Warm-White	2580~3710K

3. Table of power consumptions:

Symbol	Description
1	1W

4. Table of packaging types:

Symbol	Description
P	Tape

Absolute Maximum Ratings

Parameter	Symbol	Ratings		Unit
		Standard package	High performance package	
Max. DC Forward Current (mA)	I_F	600	800	mA
Max. Peak Pulse Current (mA)	I_{Pulse}	1000 _[1]		mA
Max. ESD Resistance	V_B	8000		V
Reverse Voltage	V_R	Note 2		V
Thermal Resistance	R_{th}	10 ~ 12		°C/W
Max. Junction Temperature	T_J	125 _[3]		°C
Operating Temperature	T_{Opr}	-40 ~ +100 _[4]		°C
Storage Temperature	T_{Stg}	-40 ~ +100		°C
Max. Soldering Temperature	T_{Sol}	260		°C
Max. Allowable Reflow Cycles	n/a	2		cycles

Notes:

1. Duty cycle = 1/10@1KHZ
2. The Shwo(D) series LEDs are not designed for reverse bias use.
3. Maximum junction temperature of Cool-White, , Neutral-White, Warm-White is 125°C.
4. Maximum Operating Temperature (Thermal Pad) of Cool-White, , Neutral-White, Warm-White LEDs is 100°C.

JEDEC Moisture Sensitivity

Level	Floor Life		Soak Requirements Standard	
	Time (hours)	Conditions	Time (hours)	Conditions
1	Unlimited	$\leq 30^\circ\text{C} / 85\% \text{ RH}$	168 (+5/-0)	85°C / 85% RH

Luminous Flux Characteristics for the Shwo(D) series

Color	Part Number	1W	
		Minimum Luminous Flux(lm) or Radiometric Power(mW) _[1]	Drive Current (mA)
Cool White	ELSWD – J21CX	110	350
	ELSWD – J31CX	120	350
Neutral White	ELSWD – F91NX	90	350
	ELSWD – J11NX	100	350
	ELSWD – J21NX	110	350
Warm White	ELSWD – F81MX	80	350
	ELSWD – F91MX	90	350

Notes:

1. Luminous flux measurement tolerance: $\pm 10\%$.
2. The data of luminous flux measured at thermal pad=25°C
3. Typical luminous flux or light output performance is operated within the condition guided by this datasheet.

Standard PN of the Shwo(D) series: White LEDs

The table below is a list of standard part numbers for the Everlight Shwo(D) 1W series White LED. All parts listed match ANSI binning standards. Bin offerings of 3000K~6500K are listed and currently available. CRI is also listed with min 70 to 80. Cool white typical view angle is 105° and warm white is 110°. These clearly listed binning options allow for proper design and implementation into lighting applications. The Order Codes below are currently available White Shwo(D) LEDs.

For Example: If you order product using P/N **ELSWD-J21C1-0LPGC-C5700**, you will be specifying:



Color	Radiation Pattern	CRI (Min.)	CCT	Forward Voltage (V)	Minimum Luminous Flux (lm)
Cool White	Lambertian	70	57K-1 ~ 57K-2 ~ 57K-3 ~ 57K-4	2.95~3.25(V1) 3.25~3.55(V2) 3.55~3.85(V3)	110

White, Shwo(D) series LEDs at 350mA are listed below

Color	Order Code of ELSWD	Minimum Luminous Flux (lm)	CCT (K) Wavelength (nm)	Forward Voltage (V)	CRI (Min.)
Cool-White 6500K	ELSWD-J21C1-0LPGC-C6500	110	65K-1~65K-4	2.95~3.85	70
Cool-White 5700K	ELSWD-J21C1-0LPGC-C5700	110	57K-1~57K-4	2.95~3.85	70
Cool-White 5000K	ELSWD-J11C1-0LPGC-C5000	100	50K-1~50K-4	2.95~3.85	70
Neutral-White 4500K	ELSWD-F91N1-0LPHC-C4500	90	45K-1~45K-4	2.95~3.85	80
Neutral-White 4000K	ELSWD-F91N1-0LPHC-C4000	90	40K-1~40K-4	2.95~3.85	80
Warm-White 3000K	ELSWD-F81M1-0LPHE-C3000	80	30K-1~30K-4	2.95~3.85	80

Notes:

1. CRI measurement tolerance: ± 2 .
2. Each 1W white PN is based on the min. bin, and includes two adjacent bins

High Performance PN of the Shwo(D) series: White LEDs

The table below is a list of high performance part numbers for the Everlight Shwo(D) 1W series White LED. All parts listed match ANSI binning standards. All ANSI bins are listed and currently available. CRI is also listed with min 70 to 80. Cool white and Warm white typical view angle is 110° and Neutral- white is 105°. These clearly listed binning options allow for proper design and implementation into lighting applications. The Order Codes below are currently available White Shwo(D) LEDs.

For Example: If you order product using P/N **ELSWD-J31C1-1LPGC-C5700**, you will be specifying:

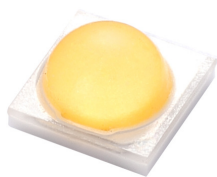

Color	Radiation Pattern	CRI (Min.)	CCT	Forward Voltage (V)	Minimum Luminous Flux (lm)
Cool White	Lambertian	70	57K-1 ~ 57K-2 ~ 57K-3 ~ 57K-4	2.95~3.25(V1) 3.25~3.55(V2) 3.55~3.85(V3)	120

White, Shwo(D) series LEDs at 350mA are listed below

Color	Order Code of ELSWD	Minimum Luminous Flux (lm)		CCT (K) Wavelength (nm)	Forward Voltage (V)		CRI (Min.)
		350mA	700mA		350mA	700mA	
Cool-White 6500K	ELSWD-J31C1-1LPGC-C6500	120	200	65K-1~65K-4	2.95~3.85	3.25~4.15	70
Cool-White 5700K	ELSWD-J31C1-1LPGC-C5700	120	200	57K-1~57K-4	2.95~3.85	3.25~4.15	70
	ELSWD-J21C1-1LPHC-C5700	110	180	57K-1~57K-4	2.95~3.85	3.25~4.15	80
Cool-White 5000K	ELSWD-J21C1-1LPGC-C5000	110	180	50K-1~50K-4	2.95~3.85	3.25~4.15	70
Neutral-White 4500K	ELSWD-J21N1-1LPGC-C4500	110	180	45K-1~45K-4	2.95~3.85	3.25~4.15	70
Neutral-White 4500K	ELSWD-J11N1-1LPHC-C4500	100	170	45K-1~45K-4	2.95~3.85	3.25~4.15	80
Neutral-White 4000K	ELSWD-J11N1-1LPGC-C4000	100	170	40K-1~40K-4	2.95~3.85	3.25~4.15	70
Neutral-White 4000K	ELSWD-J11N1-1LPHC-C4000	100	170	40K-1~40K-4	2.95~3.85	3.35~4.15	80
Warm-White 3500K	ELSWD-F91M1-1LPHE-C3500	90	150	35K-1~35K-4	2.95~3.85	3.25~4.15	80
Warm-White 3000K	ELSWD-F91M1-1LPHE-C3000	90	150	30K-1~30K-4	2.95~3.85	3.25~4.15	80
Warm-White 2700K	ELSWD-F81M1-1LPHE-C2700	80	130	27K-1~27K-4	2.95~3.85	3.25~4.15	80

Notes:

1. CRI measurement tolerance: ± 2 .
2. Each 1W white PN is based on the min. bin, and includes two adjacent bins

Color	Order Code of ELSWD	Minimum Luminous Flux (lm)		CCT (K) Wavelength (nm)	Forward Voltage (V)		CRI (Min.)
		350mA	700mA		350mA	700mA	
Warm-White 3000K	ELSWD-F81M1-0GPHE-C3000	80	130	30K-1~30K-4	2.65~3.55	2.95~3.85	80

Notes:

3. CRI measurement tolerance: ± 2 .
4. Each 1W white PN is based on the min. bin, and includes two adjacent bins

Product Binning

Luminous Flux Bins

Group	Bin	Minimum Photometric Flux (lm)	Maximum Photometric Flux (lm)
E	1	4	5
	2	5	6
	3	6	8
	4	8	10
	5	10	13
	6	13	17
	7	17	20
	8	20	23
	9	23	27
F	1	27	33
	2	33	39
	3	39	45
	4	45	52
	5	52	60
	6	60	70
	7	70	80
	8	80	90
	9	90	100

Group	Bin	Minimum Photometric Flux (lm)	Maximum Photometric Flux (lm)
J	1	100	110
	2	110	120
	3	120	130
	4	130	140
	5	140	150
	6	150	160
	7	160	180
	8	180	200
	9	200	225
K	1	225	250
	2	250	275
	3	275	300
	4	300	325
	5	325	350
	6	350	375
	7	375	400
	8	400	425
	9	425	450
N	1	450	475
	2	475	500
	3	500	525
	4	525	550

White Bin Structure

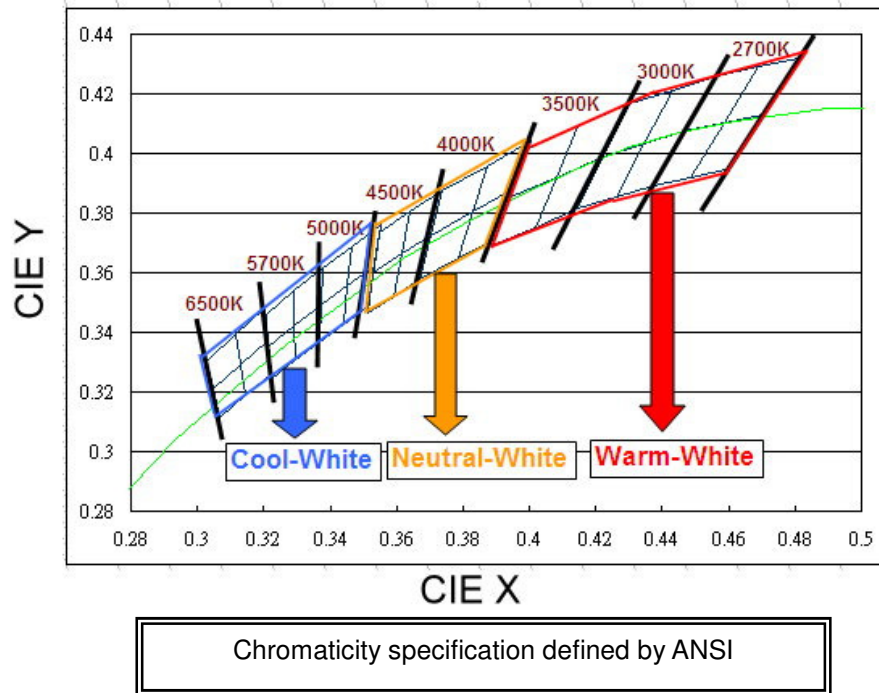

Notes:

1. The CCT range of Cool-White varies from 4745K to 7050K.
2. The CCT range of Neutral-White varies from 3710K to 4745K.
3. The CCT range of Warm-White varies from 2580K to 3710K
4. Color coordinates measurement allowance : ± 0.01
5. Color bins are defined at $I_f=350\text{mA}$ operation

Cool-White Bin Structure

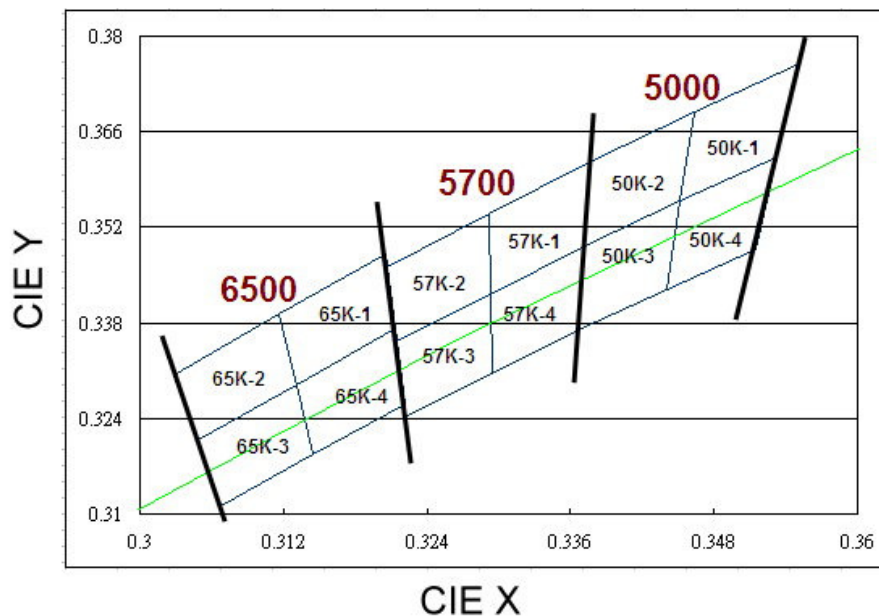

Cool-White Bin Coordinates

5000K

Bin	CIE X	CIE Y
50K-1	0.346	0.369
	0.345	0.356
	0.353	0.362
	0.355	0.376
Reference Range: 4745~5000K		

Bin	CIE X	CIE Y
50K-2	0.338	0.362
	0.337	0.349
	0.345	0.356
	0.346	0.369
Reference Range: 5000~5310K		

Bin	CIE X	CIE Y
50K-4	0.345	0.356
	0.344	0.343
	0.352	0.349
	0.353	0.362
Reference Range: 4745~5000K		

Bin	CIE X	CIE Y
50K-3	0.337	0.349
	0.337	0.337
	0.344	0.343
	0.345	0.356
Reference Range: 5000~5310K		

5700K

Bin	CIE X	CIE Y
57K-1	0.329	0.354
	0.329	0.342
	0.337	0.349
	0.338	0.362
Reference Range: 5310~5700K		

Bin	CIE X	CIE Y
57K-2	0.321	0.346
	0.321	0.335
	0.329	0.342
	0.329	0.354
Reference Range: 5700~6020K		

Bin	CIE X	CIE Y
57K-4	0.329	0.342
	0.329	0.331
	0.337	0.337
	0.337	0.349
Reference Range: 5310~5700K		

Bin	CIE X	CIE Y
57K-3	0.321	0.335
	0.322	0.324
	0.329	0.331
	0.329	0.342
Reference Range: 5700~6020K		

6500K

Bin	CIE X	CIE Y
65K-1	0.312	0.339
	0.313	0.329
	0.321	0.337
	0.321	0.348
Reference Range: 6020~6500K		

Bin	CIE X	CIE Y
65K-2	0.303	0.330
	0.305	0.321
	0.313	0.329
	0.312	0.339
Reference Range: 6500~7050K		

Bin	CIE X	CIE Y
65K-4	0.313	0.329
	0.315	0.319
	0.322	0.326
	0.321	0.337
Reference Range: 6020~6500K		

Bin	CIE X	CIE Y
65K-3	0.305	0.321
	0.307	0.311
	0.315	0.319
	0.313	0.329
Reference Range: 6500~7050K		

Neutral-White Bin Structure

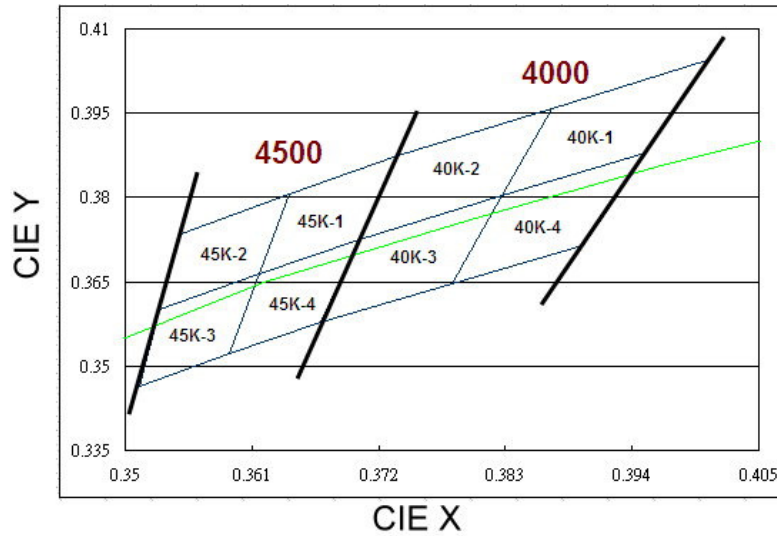

Neutral-White Bin Coordinates

4000K

Bin	CIE X	CIE Y
40K-1	0.387	0.396
	0.383	0.380
	0.395	0.388
	0.401	0.404
Reference Range: 3710~4000K		

Bin	CIE X	CIE Y
40K-2	0.374	0.387
	0.370	0.373
	0.383	0.380
	0.387	0.396
Reference Range: 4000~4260K		

Bin	CIE X	CIE Y
40K-4	0.383	0.380
	0.378	0.365
	0.390	0.372
	0.395	0.388
Reference Range: 3710~4000K		

Bin	CIE X	CIE Y
40K-3	0.370	0.373
	0.367	0.358
	0.378	0.365
	0.383	0.380
Reference Range: 4000~4260K		

4500K

Bin	CIE X	CIE Y
45K-1	0.364	0.381
	0.362	0.366
	0.370	0.373
	0.374	0.387
Reference Range: 4260~4500K		

Bin	CIE X	CIE Y
45K-2	0.355	0.374
	0.353	0.360
	0.362	0.366
	0.364	0.381
Reference Range: 4500~4745K		

Bin	CIE X	CIE Y
45K-4	0.362	0.366
	0.359	0.352
	0.367	0.358
	0.370	0.373
Reference Range: 4260~4500K		

Bin	CIE X	CIE Y
45K-3	0.353	0.360
	0.351	0.347
	0.359	0.352
	0.362	0.366
Reference Range: 4500~4745K		

Warm-White Bin Structure

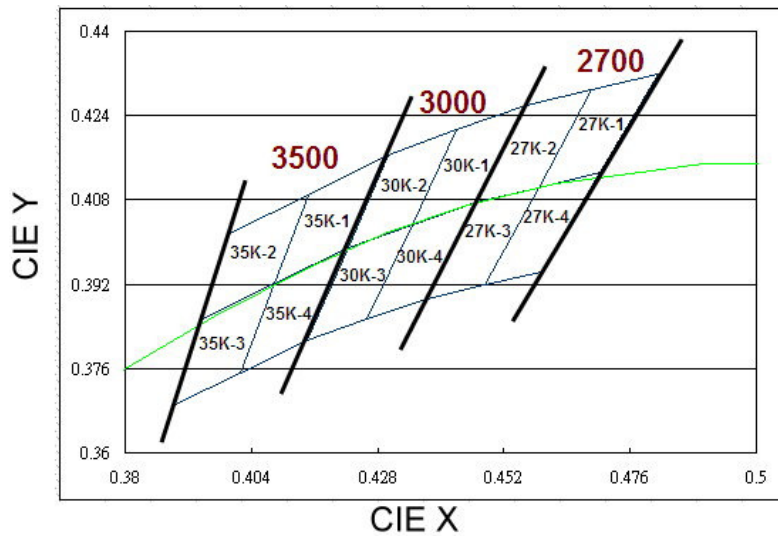

Warm-White Bin Coordinates

2700K

Bin	CIE X	CIE Y
27K-1	0.469	0.429
	0.459	0.410
	0.470	0.413
	0.481	0.432
Reference Range: 2580~2700K		

Bin	CIE X	CIE Y
27K-2	0.456	0.426
	0.447	0.408
	0.459	0.410
	0.469	0.429
Reference Range: 2700~2870K		

Bin	CIE X	CIE Y
27K-4	0.459	0.410
	0.448	0.392
	0.459	0.394
	0.470	0.413
Reference Range: 2580~2700K		

Bin	CIE X	CIE Y
27K-3	0.447	0.408
	0.437	0.389
	0.448	0.392
	0.459	0.410
Reference Range: 2700~2870K		

3000K

Bin	CIE X	CIE Y
30K-1	0.443	0.421
	0.435	0.403
	0.447	0.408
	0.456	0.426
Reference Range: 2870~3000K		

Bin	CIE X	CIE Y
30K-2	0.430	0.417
	0.422	0.399
	0.435	0.403
	0.443	0.421
Reference Range: 3000~3220K		

Bin	CIE X	CIE Y
30K-4	0.435	0.403
	0.426	0.385
	0.437	0.389
	0.447	0.408
Reference Range: 2870~3000K		

Bin	CIE X	CIE Y
30K-3	0.422	0.399
	0.415	0.381
	0.426	0.385
	0.435	0.403
Reference Range: 3000~3220K		

3500K

Bin	CIE X	CIE Y
35K-1	0.415	0.409
	0.408	0.392
	0.422	0.399
	0.430	0.417
Reference Range: 3220~3500K		

Bin	CIE X	CIE Y
35K-2	0.400	0.402
	0.394	0.385
	0.408	0.392
	0.415	0.409
Reference Range: 3500~3710K		

Bin	CIE X	CIE Y
35K-4	0.408	0.392
	0.402	0.375
	0.415	0.381
	0.422	0.399
Reference Range: 3220~3500K		

Bin	CIE X	CIE Y
35K-3	0.394	0.385
	0.389	0.369
	0.402	0.375
	0.408	0.392
Reference Range: 3500~3710K		

Note: Currently available typical CCT ranges are 3000K, 5700K, and 6500K CCT.

Forward Voltage Bins

Group Name	Bins
A	U1+U2+U3+U4
B	U2+U3+U4+V1
C	U4+V1+V2+V3
D	V1+V2+V3+V4

Bin	Minimum Forward Voltage (V)	Maximum Forward Voltage (V)
U1	1.75	2.05
U2	2.05	2.35
U3	2.35	2.65
U4	2.65	2.95
V1	2.95	3.25
V2	3.25	3.55
V3	3.55	3.85
V4	3.85	4.15

Notes:

1. Forward voltage measurement tolerance: $\pm 0.1V$.
2. Forward voltage bins are defined at $I_f=350mA$ operation.
3. Other Forward Voltage bins for White LEDs available upon request. Please contact your local Everlight sales office.

Optical Characteristics

Color	Part Number	Dominant Wavelength λ_D Peak Wavelength λ_P Color Temperature CCT			Typical Temperature Coefficient of Dominant Wavelength (nm/°C)-($\Delta\lambda_D/\Delta T_J$)	Typical Viewing Angle (degrees) $2\theta_{1/2}$
		Min.	Typ.	Max.		
Cool-White	ELSWD – XX1CX	4745K	5700K	7050K	---	110
Neutral-White	ELSWD – XX1NX	3710K	4260K	4745K		105
Warm-White	ELSWD– XX1MX	2580K	3000K	3710K	---	110

Notes:

1. The test tolerance of Everlight is $\pm 0.5\text{nm}$ for dominant wavelength, $\pm 5\%$ for CCT.
2. Viewing angle is the width of half the light output intensity in all directions of 180° .
3. All Cool-White, Neutral-White, Warm-White, and dominant wavelength below 550nm LEDs are made with Indium Gallium Nitride (InGaN).
4. Typical view angle of ELSWD-XX1X1-0L series is 110°
5. View angle tolerance is $\pm 5^\circ$.

Mechanical Dimension

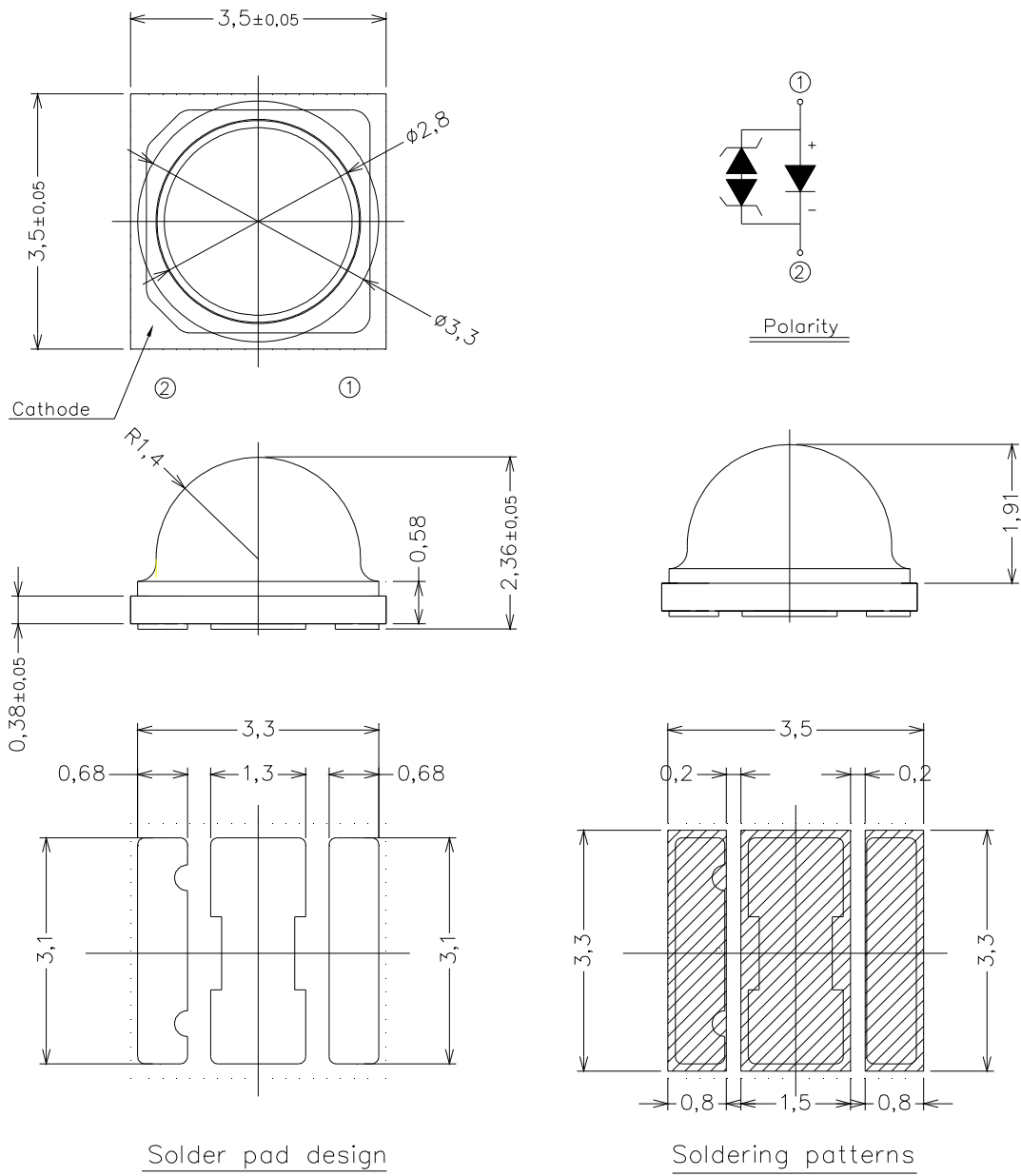

Notes:

1. Dimensions are in millimeters.
2. Tolerances unless mentioned are $\pm 0.15\text{mm}$.
3. The thermal pad is electrically isolated from the Anode and Cathode contact pads.
4. Do not handle the device by the lens. Incorrect force applied to the lens may lead to the failure of devices.

Pad Configuration

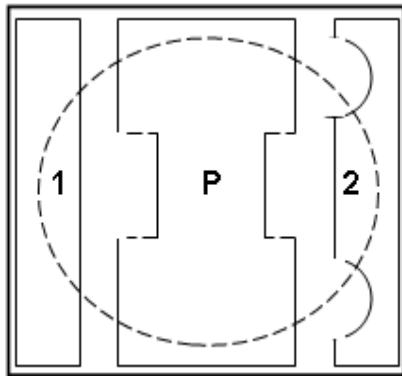

BOTTOM VIEW

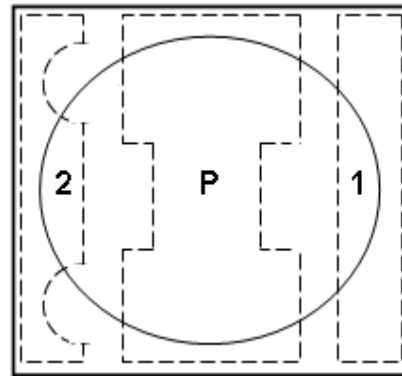

TOP VIEW

PAD	FUNCTION
1	ANODE
2	CATHODE
P	THERMAL PAD

Reflow Soldering Characteristics

For Reflow Process

- ELSWD series are suitable for SMT processes.
- Curing of glue in oven must be according to standard operation flow processes.

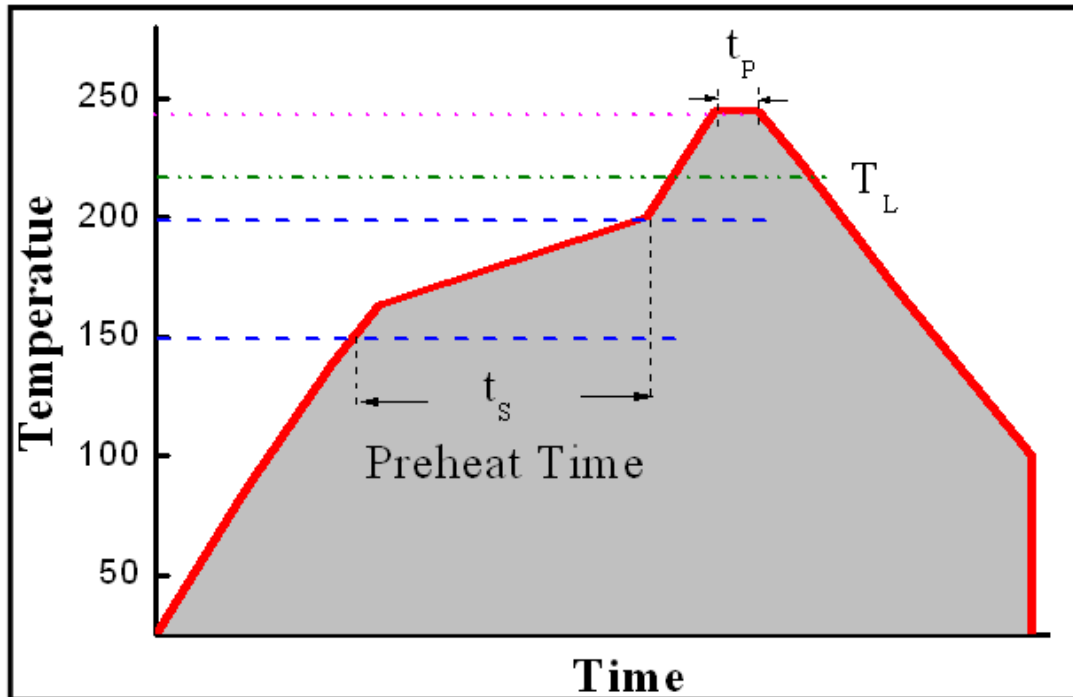

Profile Feature	Lead Free Assembly
Ramp-Up Rate	2-3 °C/S
Preheat Temperature	150-200 °C
Preheat Time (t_s)	60-120 S
Liquid Temperature (T_L)	217 °C
Time maintained above T_L	60-90 S
Peak Temperature (T_p)	240±5 °C
Peak Time (t_p)	Max 20 S
Ramp-Down Rate	3-5 °C/S

- Reflow soldering should not be done more than twice.
- In soldering process, stress on the LEDs during heating should be avoided.
- After soldering, do not bend the circuit board.

Wavelength Characteristics

For Cool-White, @ Thermal Pad Temperature = 25°C

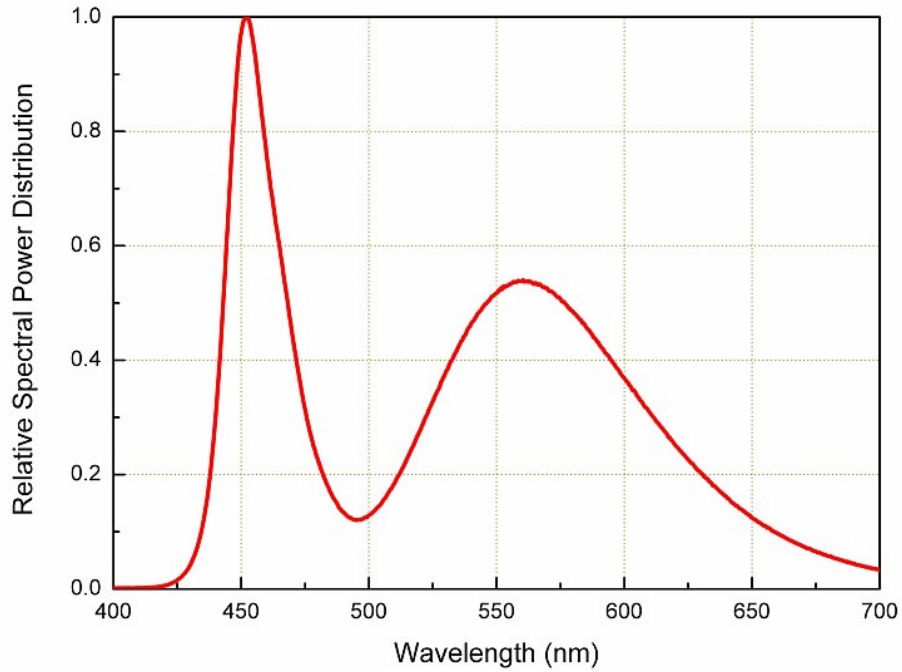

For Neutral-White, @ Thermal Pad Temperature = 25°C

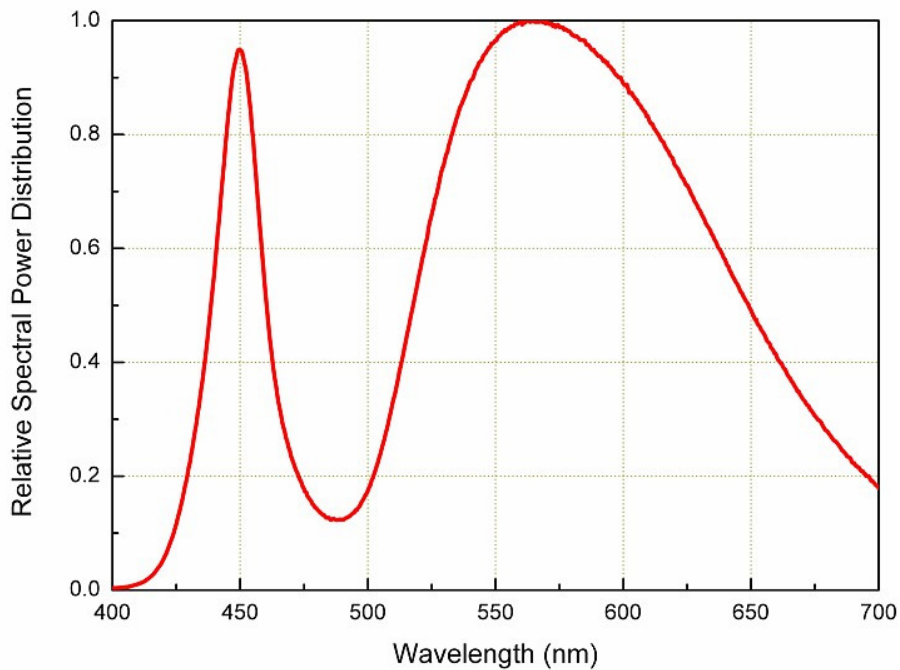

For Warm-White, @ Thermal Pad Temperature = 25°C

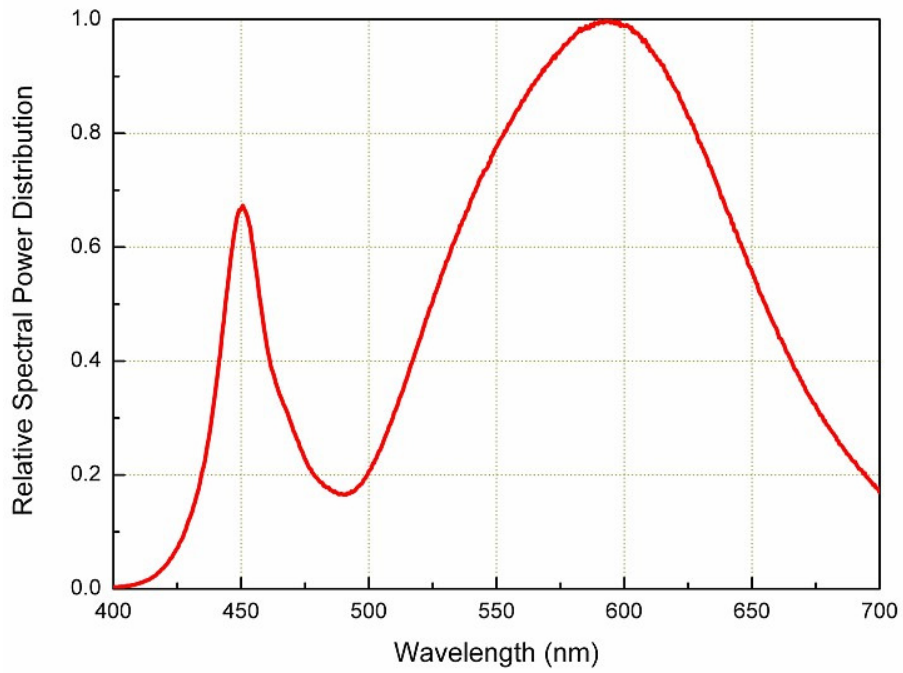

Typical Light Output Characteristic V.S. Thermal Pad Temperature

Cool-White, Neutral-White, Warm-White
for 350mA Drive Current

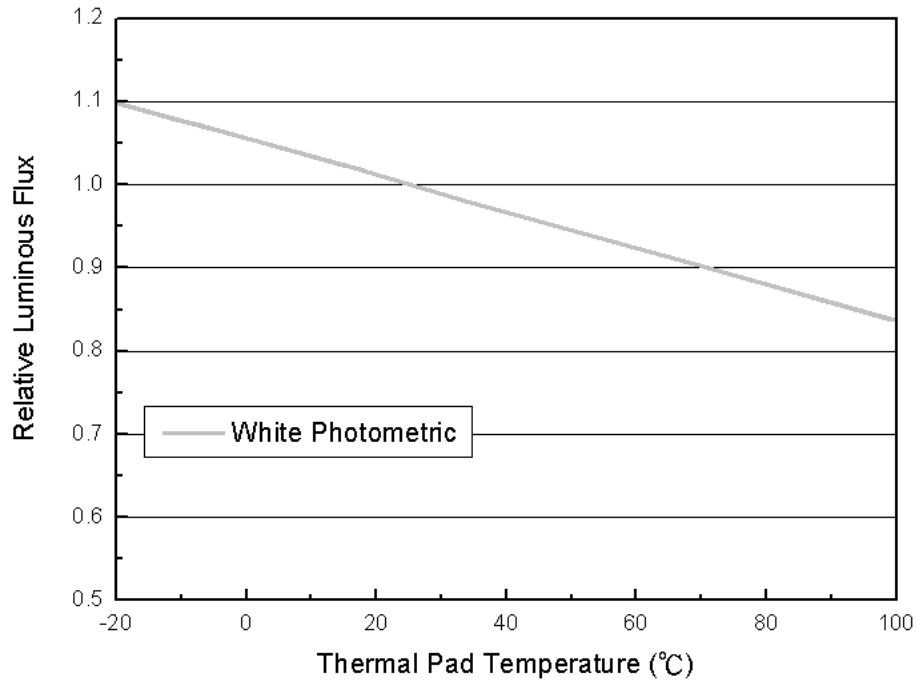

Typical Electrical Characteristics

For Cool-White, Neutral-White, Warm-White
@ Thermal Pad Temperature = 25°C

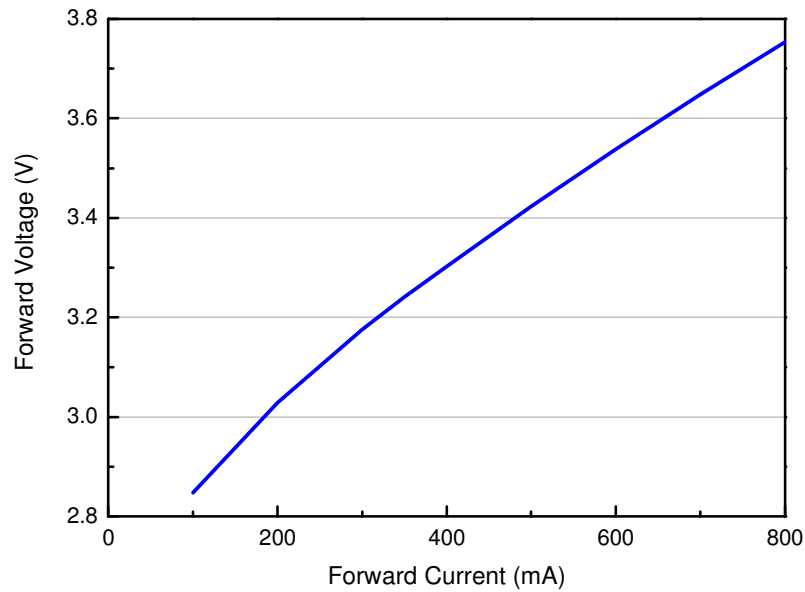

Typical Relative Luminous Flux V.S. Forward Current

For Cool-White, Neutral-White, Warm-White
@ Thermal Pad Temperature = 25°C

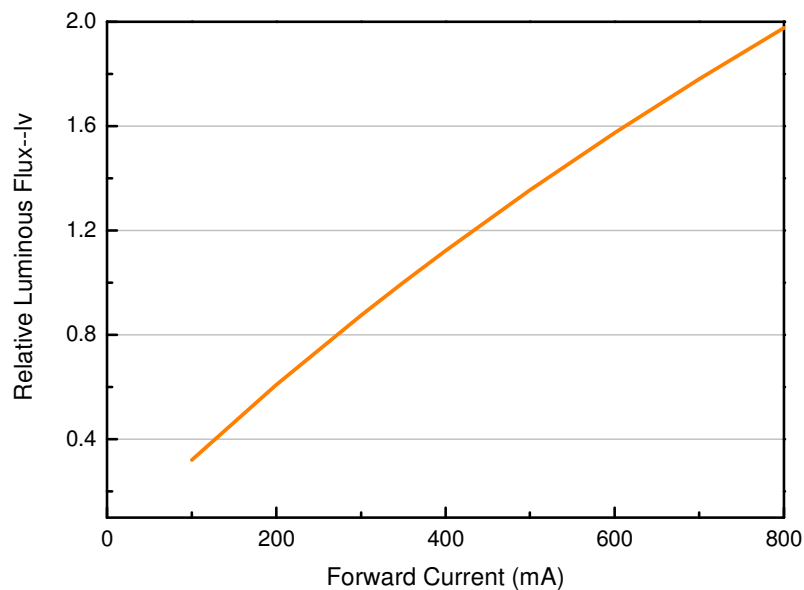

Typical Wavelength & CCT Shift Characteristics V.S. Forward Current

For Cool-White @ Thermal Pad Temperature = 25°C

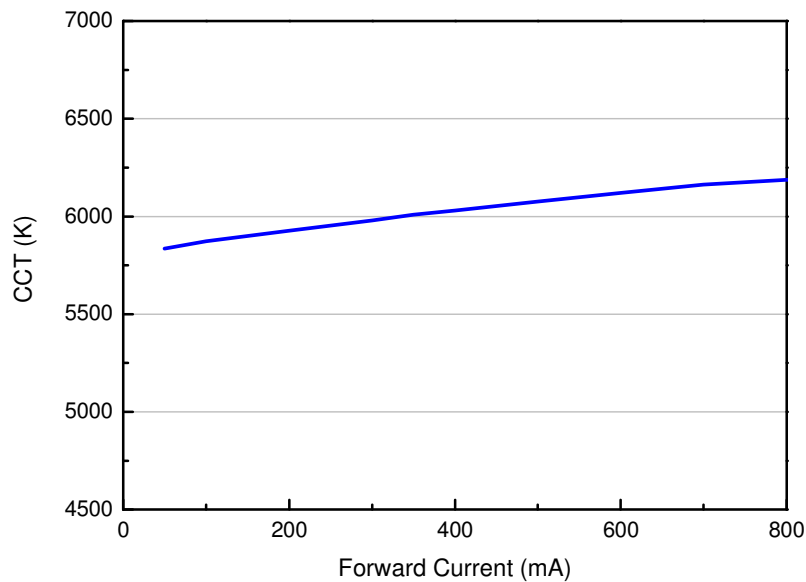

For Neutral-White @ Thermal Pad Temperature = 25°C

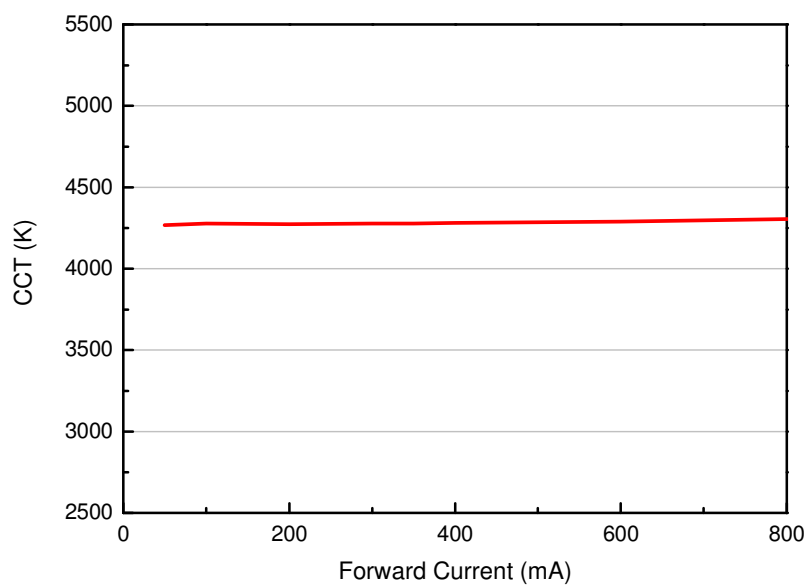

For Warm-White @ Thermal Pad Temperature = 25°C

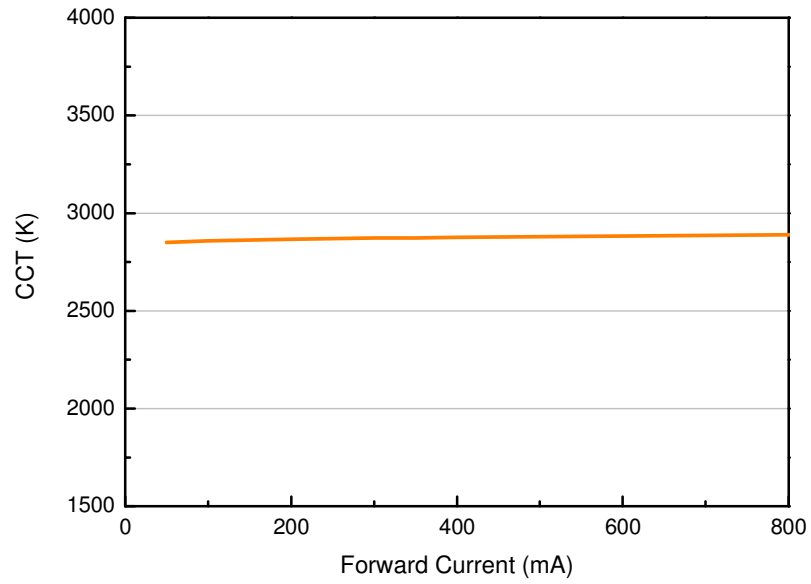

Relative Flux and Forward Voltage V.S. Junction Temperature (IF = 350 mA)

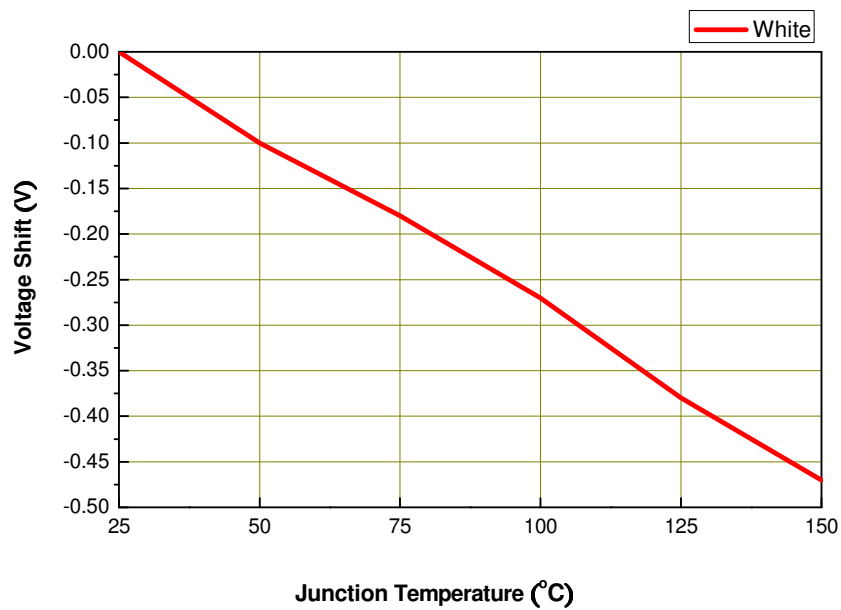
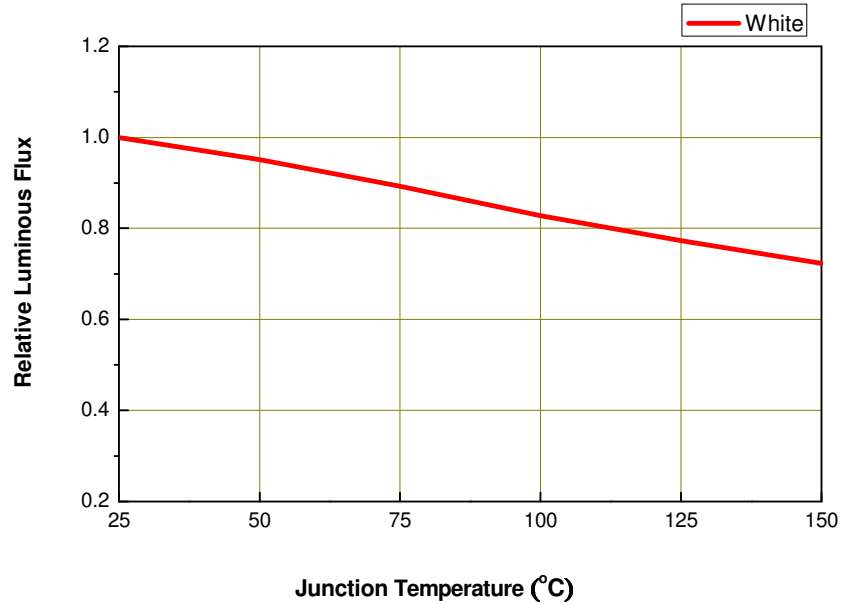

Current Derating Curves

Current Derating Curve for 800mA Drive Current
Cool-White, Neutral-White, Warm-White

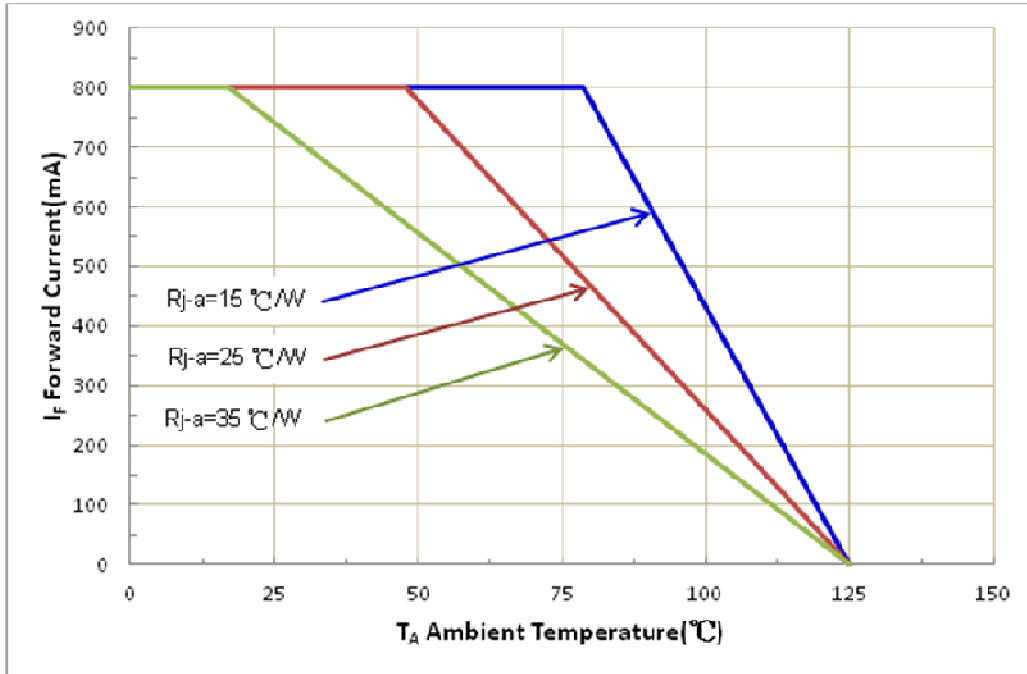

Current Derating Curve for 600mA Drive Current
Cool-White, Neutral-White, Warm-White

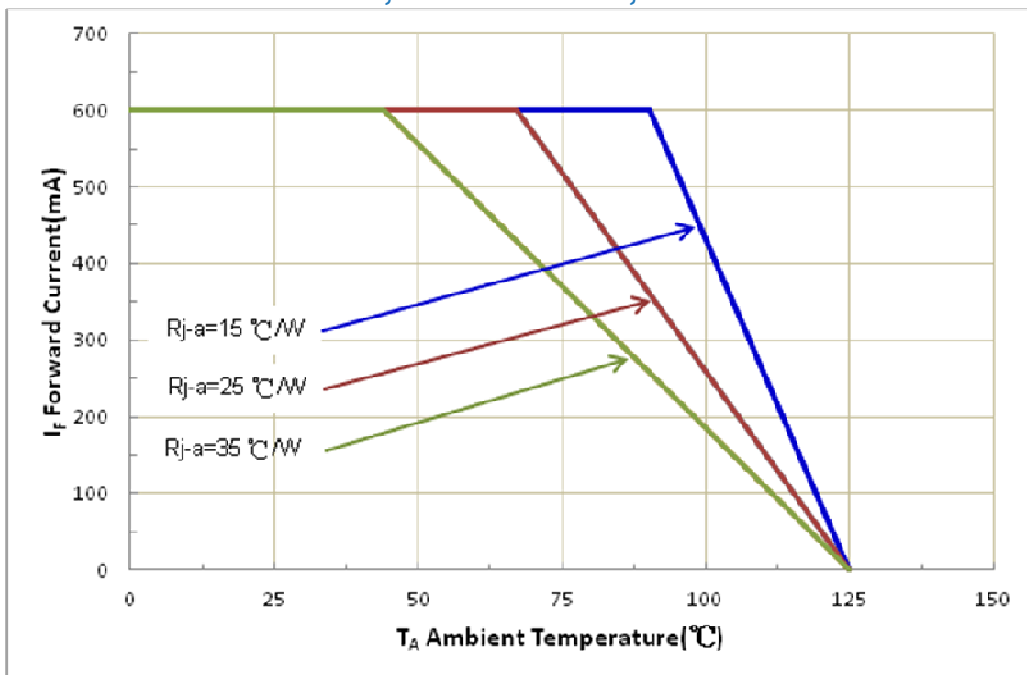

Typical Radiation Patterns

Shwo(D) series: Typical Diagram Characteristics of Radiation for Cool-White, Warm-White

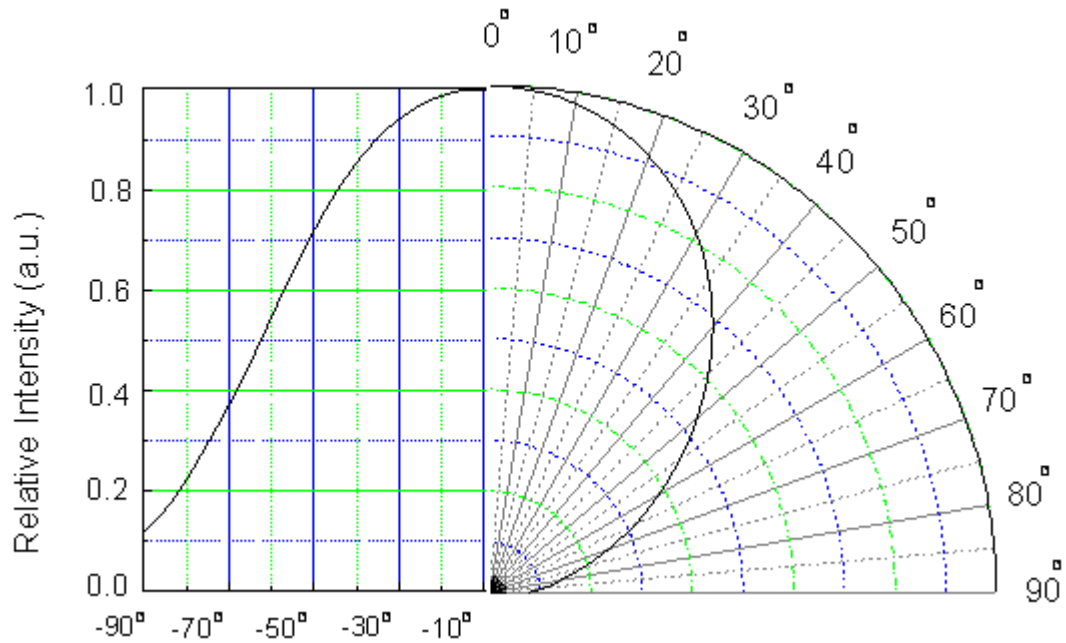

Notes:

1. $2\theta_{1/2}$ is the off axis angle from lamp centerline where the luminous intensity is 1/2 of the peak value.
2. View angle tolerance is $\pm 5^\circ$.

Emitter Reel Packaging

Reel Dimensions

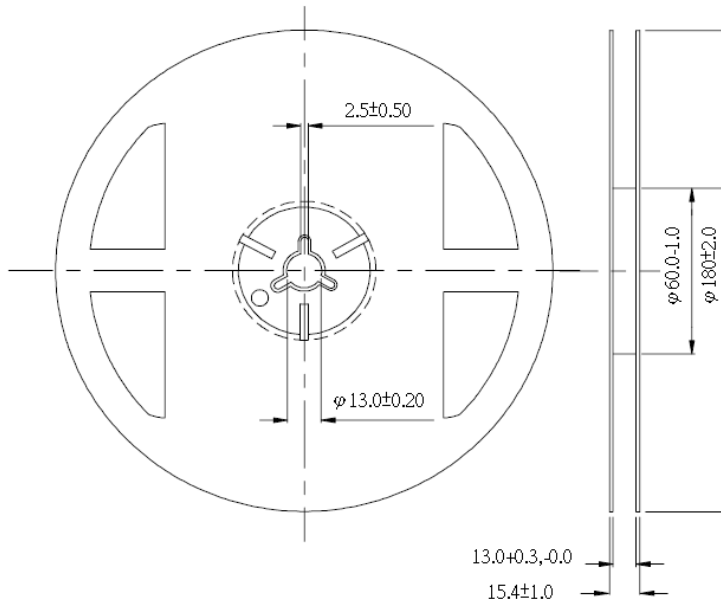

Notes:

1. Dimensions are in millimeters.
2. Tolerances unless mentioned are ± 0.1 mm.

Product Labeling

Label Explanation

CPN: Customer Specification (when required)

P/N : Everlight Production Number

QTY: Packing Quantity

CAT: Luminous Flux (Brightness) Bin

HUE: Color Bin

REF: Forward Voltage Bin

LOT No: Lot Number

MADE IN TAIWAN: Production Place



Storage Conditions

- Before the package is opened: The LEDs should be stored at 30°C or less and 85%RH or less after being shipped from Everlight and the storage life limits are 1 year. The LEDs can be stored up to 3 years if in a sealed container with a nitrogen atmosphere and moisture absorbent material.
- After the package is opened: The LED's floor life is 1 year under 30°C or less and 60%RH or less. The LED should be soldered within 168hrs (7days) after opening the package. If unused LEDs remain, it should be stored in moisture proof packages.
- If the moisture absorbent material (silica gel) has faded away or the LEDs have exceeded the storage time, baking treatment should be performed using the following conditions. Baking treatment: 60±5°C for 24 hours.

Revision History

Current version: **2012/11/14**
Device No. DHE-0001766
Rev. Ver. 9

Page	Subjects (major change in previous version)	Date of change
6	The order code is changed.	2012/02/22
6、7、 25	Added new PN & Modify PN Modify Mechanical Dimension & Current Derating Curves	2012/08/09
7	Modify 700mA IV spec.	2012/08/30
15	Modify View angle spec.	2012/09/20
7	Add New PN	2012/10/16
6	Add New PN	2012/10/19
7	Modify Warm white PN & add new PN	2012/11/08
8	Modify PN	2012/11/14
6、27	Modify PN & Add 600mA Current Derating Curve	2013/09/24

X-ON Electronics

Largest Supplier of Electrical and Electronic Components

Click to view similar products for [Standard LEDs - SMD category](#):

Click to view products by [Everlight manufacturer](#):

Other Similar products are found below :

[LTST-C190KYKT](#) [LTST-C19GD2WT](#) [LTST-N683GBEW](#) [LTW-170ZDC](#) [LTW-M140SZS40](#) [598-8110-100F](#) [598-8170-100F](#) [598-8610-202F](#) [AAAF5060QBFSEEZGS](#) [HLMA-QG00-S0021](#) [ALMD-LB36-SV002](#) [APT1608QGW](#) [EAST2012YA0](#) [EASV1803BA0](#) [LG M67K-H1J2-24-0-2-R18-Z](#) [SML-512VWT86A](#) [SML-LX0606SISUGC/A](#) [SML-LXL1307SRC-TR](#) [SML-LXR851SIUPGUBC](#) [LT1ED53A](#) [AM27ZGC03](#) [APB3025SGNC](#) [APFA3010SURKCGKQBDC](#) [APHK1608VGCA](#) [APT2012QGW](#) [CLX6D-FKB-CN1R1H1BB7D3D3](#) [LTST-008BGEW](#) [LTST-C250KGKT](#) [LTW-010DCG](#) [LTW-020ZDCG](#) [LTW-21TS5](#) [LTW-220DS5](#) [598-8330-117F](#) [SML-LX0402IC-TR](#) [CMDA20AYAA7D1S](#) [CMDA16AYDR7A1X](#) [91-21SYGD/S530-E2/TR7](#) [HSMQ-C177](#) [598-8040-100F](#) [598-8070-100F](#) [598-8140-100F](#) [598-8610-200F](#) [EAST2012GA0](#) [EAPL3527GA5](#) [SML-LXL1209SYC/ATR](#) [EAST2012RA0](#) [EAST1608RGBAO](#) [CMD91-21VRC/TR7](#) [SML-LXR851SGSIC-TR](#) [SML-512PWT86A](#)