



Technical Data Sheet

3mm Infrared LED, T-1

IR204/H16/L10

Features

- High reliability
- 2.54mm lead spacing
- Low forward voltage
- Good spectral matching to Si photodetector
- Pb free
- The product itself will remain within RoHS compliant version.

Descriptions

EVERLIGHT's infrared emitting diode (IR204/H16/L10) is a high intensity diode, molded in a blue transparent plastic package.

The device is spectrally matched with phototransistor, photodiode and infrared receiver module.



Applications

- Free air transmission system
- Optoelectronic switch
- Floppy disk drive
- Infrared applied system
- Smoke detector

Device Selection Guide

| LED Part No. | Chip | Lens Color |
|--------------|----------|------------|
| | Material | |
| IR | GaAlAs | Blue |

Package Dimensions

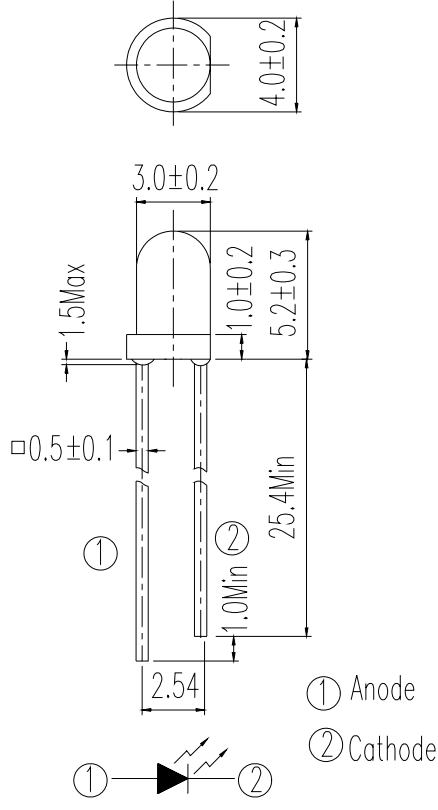

- Notes:** 1.All dimensions are in millimeters
2.Tolerances unless dimensions ± 0.25 mm

Absolute Maximum Ratings (Ta=25°C)

| Parameter | Symbol | Rating | Units |
|---|-----------|-----------|-------|
| Continuous Forward Current | I_F | 100 | mA |
| Peak Forward Current | I_{FP} | 1.0 | A |
| Reverse Voltage | V_R | 5 | V |
| Operating Temperature | T_{opr} | -40 ~ +85 | °C |
| Storage Temperature | T_{stg} | -40 ~ +85 | °C |
| Soldering Temperature | T_{sol} | 260 | °C |
| Power Dissipation at(or below) 25°C Free Air Temperature | P_d | 150 | mW |

- Notes:** *1: I_{FP} Conditions--Pulse Width $\leq 100 \mu s$ and Duty $\leq 1\%$.
*2:Soldering time ≤ 5 seconds.

Electro-Optical Characteristics (Ta=25°C)

| Parameter | Symbol | Condition | Min. | Typ. | Max. | Units |
|--------------------|----------------|---|------|------|------|-------|
| Radiant Intensity | E _e | I _F =20mA | 2.8 | 4.0 | --- | mW/sr |
| | | I _F =100mA Pulse Width ≤ 100 μs and Duty ≤ 1% | --- | 35 | --- | |
| | | I _F =1A Pulse Width ≤ 100 μs and Duty ≤ 1% | --- | 350 | --- | |
| Peak Wavelength | λ _p | I _F =20mA | --- | 940 | --- | nm |
| Spectral Bandwidth | Δλ | I _F =20mA | --- | 45 | --- | nm |
| Forward Voltage | V _F | I _F =20mA | --- | 1.2 | 1.5 | V |
| | | I _F =100mA Pulse Width ≤ 100 μs and Duty ≤ 1% | --- | 1.4 | 1.8 | |
| | | I _F =1A Pulse Width ≤ 100 μs and Duty ≤ 1% | --- | 2.6 | 4.0 | |
| Reverse Current | I _R | V _R =5V | --- | -- | 10 | μA |
| View Angle | 2θ 1/2 | I _F =20mA | --- | 50 | --- | deg |

Typical Electro-Optical Characteristics Curves

Fig.1 Forward Current vs. Ambient Temperature

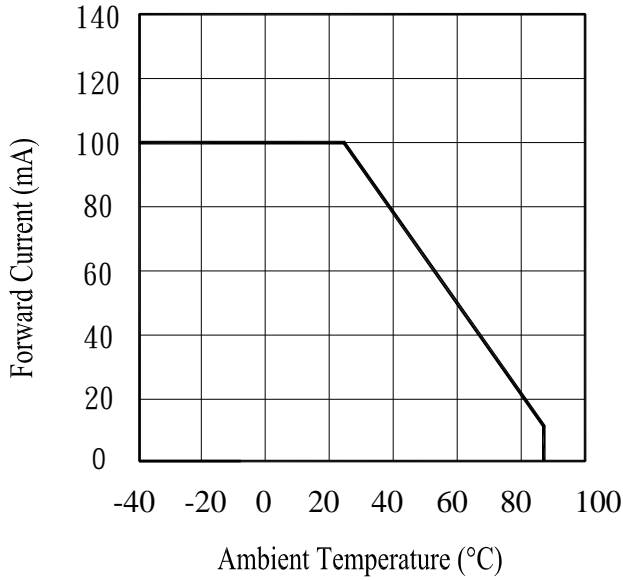

Fig.2 Spectral Distribution

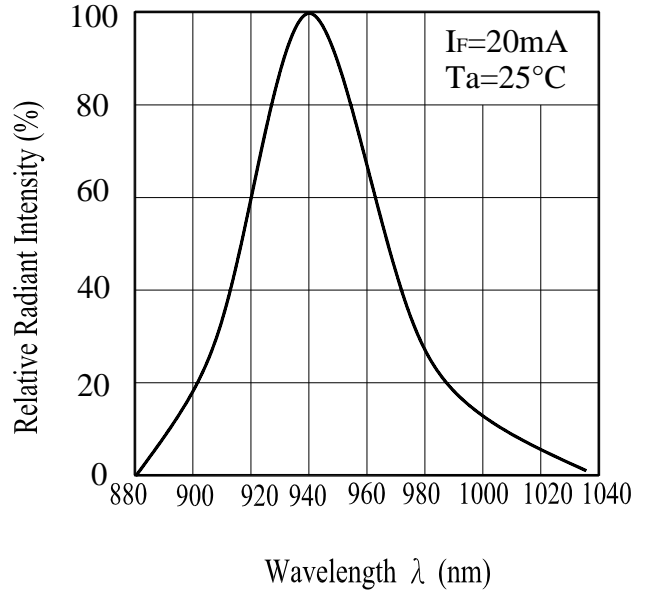

Fig.3 Peak Emission Wavelength vs. Ambient Temperature

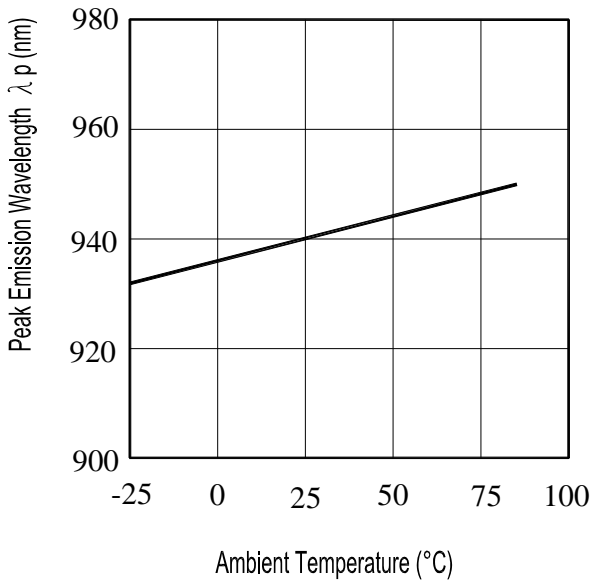
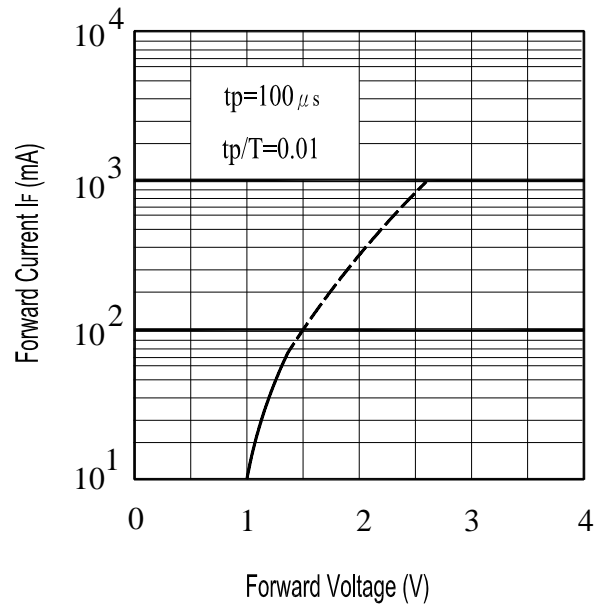

Fig.4 Forward Current vs. Forward Voltage



Typical Electro-Optical Characteristics Curves

Fig.5 Relative Intensity vs. Forward Current

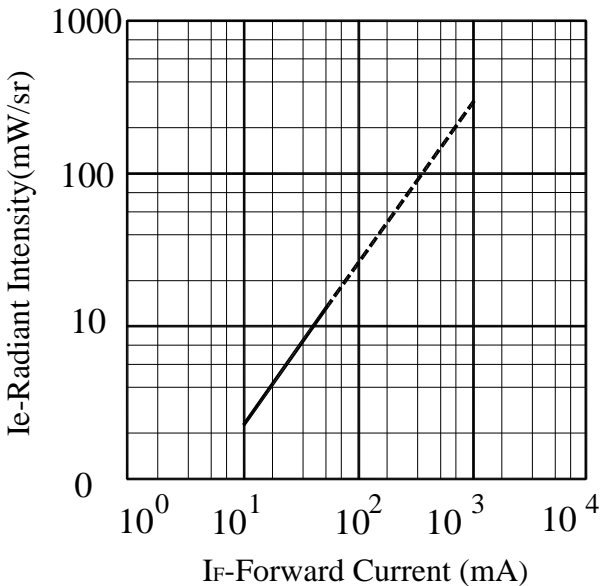

Fig.6 Relative Radiant Intensity vs. Angular Displacement

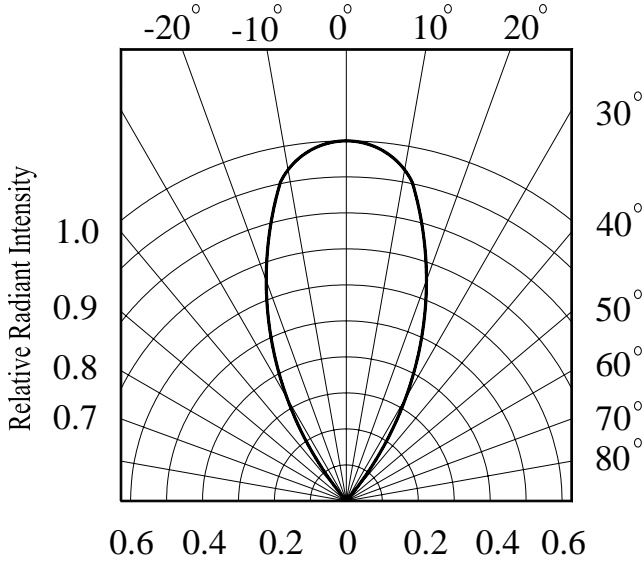

Fig.7 Relative Intensity vs. Ambient Temperature(°C)

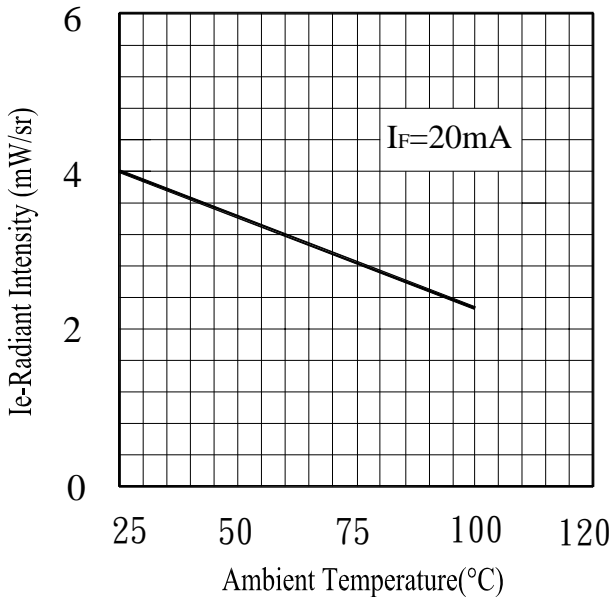
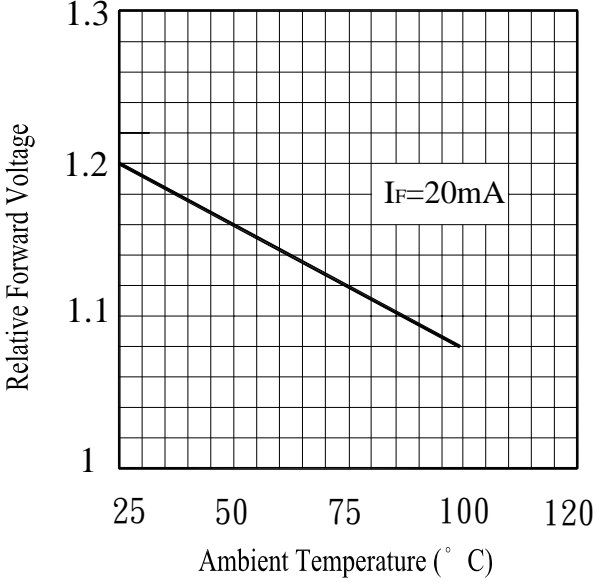

Fig.8 Forward Voltage vs. Ambient Temperature(°C)



Reliability Test Item And Condition

The reliability of products shall be satisfied with items listed below.

Confidence level : 90%

LTPD : 10%

| NO. | Item | Test Conditions | Test Hours/ Cycles | Sample Sizes | Failure Judgement Criteria | Ac/Re |
|-----|------------------------------------|--|-----------------------|-----------------|---|-------|
| 1 | Solder Heat | TEMP. : 260°C±5°C | 10secs | 22pcs | | 0/1 |
| 2 | Temperature Cycle | H : +100°C 15mins ↑ 5mins ↓ 15mins L : -40°C | 300Cycles | 22pcs | $I_R \geq U \times 2$ $E_e \leq L \times 0.8$ $V_F \geq U \times 1.2$ | 0/1 |
| 3 | Thermal Shock | H : +100°C 5mins ↑ 10secs ↓ 5mins L : -10°C | 300Cycles | 22pcs | U : Upper Specification | 0/1 |
| 4 | High Temperature Storage | TEMP. : +100°C | 1000hrs | 22pcs | Limit L : Lower | 0/1 |
| 5 | Low Temperature Storage | TEMP. : -40°C | 1000hrs | 22pcs | Specification Limit | 0/1 |
| 6 | DC Operating Life | $I_F = 20mA$ | 1000hrs | 22pcs | | 0/1 |
| 7 | High Temperature/ High Humidity | 85°C / 85% R.H | 1000hrs | 22pcs | | 0/1 |



IR204/H16/L10

Packing Quantity Specification

1. 1000PCS/1Bag , 4Bags/1Box
2. 10Boxes/1Carton

Label Form Specification

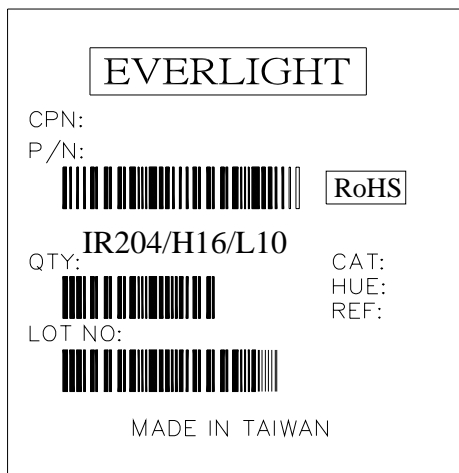

CPN: Customer's Production Number

P/N : Production Number

QTY: Packing Quantity

CAT: Ranks

HUE: Peak Wavelength

REF: Reference

LOT No: Lot Number

MADE IN TAIWAN: Production Place

Notes

1. Above specification may be changed without notice. EVERLIGHT will reserve authority on material change for above specification.
2. When using this product, please observe the absolute maximum ratings and the instructions for using outlined in these specification sheets. EVERLIGHT assumes no responsibility for any damage resulting from use of the product which does not comply with the absolute maximum ratings and the instructions included in these specification sheets.
3. These specification sheets include materials protected under copyright of EVERLIGHT corporation. Please don't reproduce or cause anyone to reproduce them without EVERLIGHT's consent.

EVERLIGHT ELECTRONICS CO., LTD.

Office: No 25, Lane 76, Sec 3, Chung Yang Rd,
Tucheng, Taipei 236, Taiwan, R.O.C

Tel: 886-2-2267-2000, 2267-9936

Fax: 886-2267-6244, 2267-6189, 2267-6306

<http://www.everlight.com>

X-ON Electronics

Largest Supplier of Electrical and Electronic Components

Click to view similar products for [Infrared Emitters](#) category:

Click to view products by [Everlight](#) manufacturer:

Other Similar products are found below :

[LTE-3279K](#) [LTE-4206C](#) [LTE-4208C](#) [EAILP03RDAA6](#) [LTE-2871C](#) [LTE-4238](#) [ASDL-4264-C22](#) [EAIPL3528Z0](#) [OED-EL305F4C50-HT](#)
[OP216-004](#) [LTE-3376](#) [IN-S126ETIR](#) [IN-S126DSHIR](#) [IN-S126ETHIR](#) [IN-P32ZTHIR](#) [IN-S42CTQHIR](#) [IN-S63DTHIR](#) [IN-S85BTHIR](#) [IN-](#)
[S63FTHIR](#) [HIR204C/H0](#) [HIR204/H0](#) [HIR323C](#) [LTE-209](#) [IR12-21C/TR8](#) [IR17-21C/TR8](#) [IR26-21C/L110/TR8](#) [IR383](#) [IR91-21C/TR10](#) [KM-](#)
[4457F3C](#) [L-53F3BT](#) [WP7113F3BT](#) [WP7113F3C](#) [LTE-4208](#) [OP235W](#) [OP297FAB](#) [WP7113SF6C](#) [IR67-21CTR8](#) [IR42-21C/TR8](#) [IR204C-A](#)
[HSDL-4261](#) [APT1608SF4C-PRV](#) [APA3010F3C-GX](#) [MTE1077N1-R](#) [MTE1081C](#) [MTE1300N](#) [MTE8600M2](#) [MTE9440M3A](#) [MTE9440N](#)
[MTE9460MC](#) [MTMS8800T38](#)