

## Technical Data Sheet

### 1.6mm round Subminiature Side Looking Infrared LED IR26-61C/L261/TR8

#### Features

- Small double-end package
- Low forward voltage
- Good spectral matching to Si photo detector
- Package in 8mm tape on 7" diameter reel.
- Pb free
- The product itself will remain within RoHS compliant version.
- Compliance with EU REACH.
- Compliance Halogen Free .(Br <900 ppm ,Cl <900 ppm , Br+Cl < 1500 ppm)

#### Description

- IR26-61C/L261/TR8 is an infrared emitting diode in miniature SMD package which is molded in a water clear plastic with spherical top view lens. The device is spectrally matched with silicon photodiode and phototransistor.

#### Applications

- Infrared applied system

#### Device Selection Guide

Device No.	Chip Material	Lens Color
IR26-61C/L261/TR8	GaAlAs	Water Clear

**Package Dimensions**

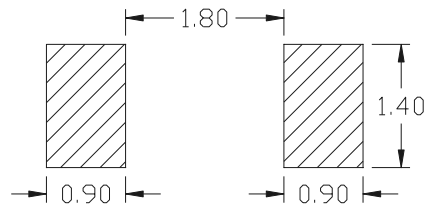
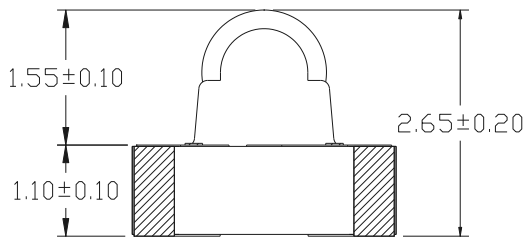
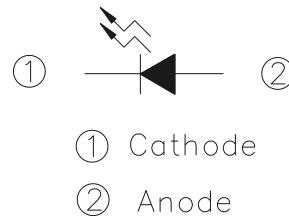
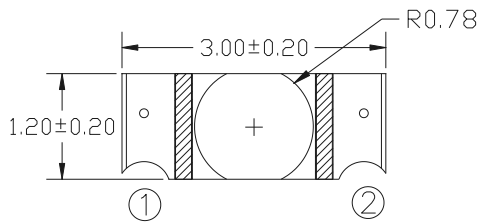

Recommended Soldering Pattern  
for Side Looker

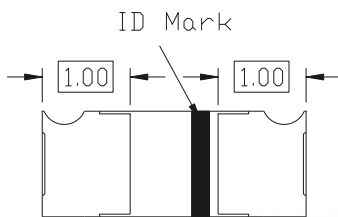

- Notes:** 1.All dimensions are in millimeters  
2.Tolerances unless dimensions  $\pm 0.1\text{mm}$

**Absolute Maximum Ratings (Ta=25°C)**

Parameter	Symbol	Rating	Unit
Continuous Forward Current	$I_F$	65	mA
Reverse Voltage	$V_R$	5	V
Peak Forward Current *1	$I_{FP}$	400	mA
Operating Temperature	$T_{opr}$	-40 ~ +85	°C
Storage Temperature	$T_{stg}$	-40 ~ +100	°C
Soldering Temperature *2	$T_{sol}$	260	°C
Power Dissipation at(or below) 25°C Free Air Temperature	$P_d$	100	mW

- Notes:** \*1: $I_{FP}$  Conditions--Pulse Width  $\leq 10\mu\text{s}$  and Duty  $\leq 20\%$   
\*2:Soldering time  $\leq 5$  seconds

Electro-Optical Characteristics (Ta=25°C)

Parameter	Symbol	Min.	Typ.	Max.	Unit	Condition
Radiant Intensity	I <sub>e</sub>	2.0	5.0	--	mW/sr	I <sub>F</sub> =20mA
		--	25	--		I <sub>F</sub> =100mA Pulse Width ≤ 100μ s ,Duty ≤ 1%
Peak Wavelength	λ <sub>p</sub>	--	940	--	nm	I <sub>F</sub> =20mA
Spectral Bandwidth	Δλ	--	50	--	nm	I <sub>F</sub> =20mA
Forward Voltage	V <sub>F</sub>	--	1.2	1.5	V	I <sub>F</sub> =20mA
		--	1.4	1.8		I <sub>F</sub> =100mA Pulse Width ≤ 100μ s ,Duty ≤ 1%
Reverse Current	I <sub>R</sub>	--	--	10	μ A	V <sub>R</sub> =5V
View Angle	2θ <sub>1/2</sub>	--	30	--	deg	I <sub>F</sub> =20mA

EVERLIGHT

Typical Electrical/Optical/Characteristics Curves

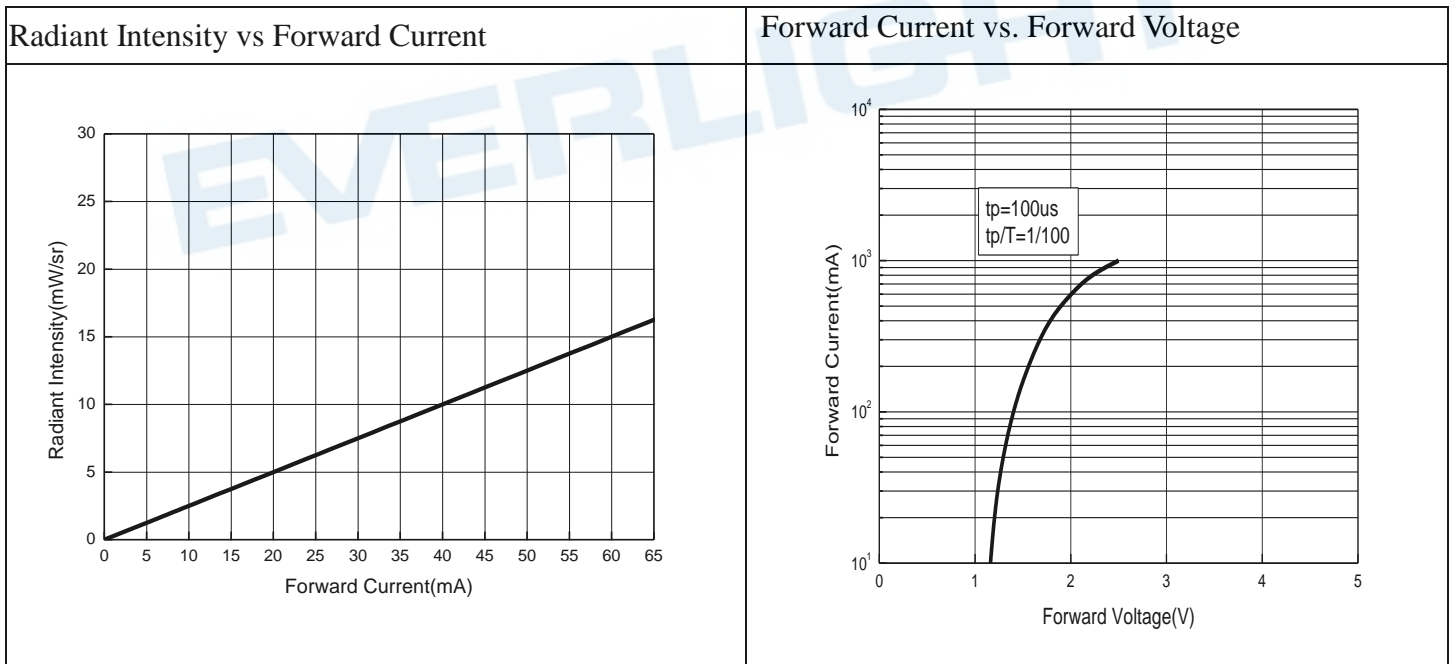
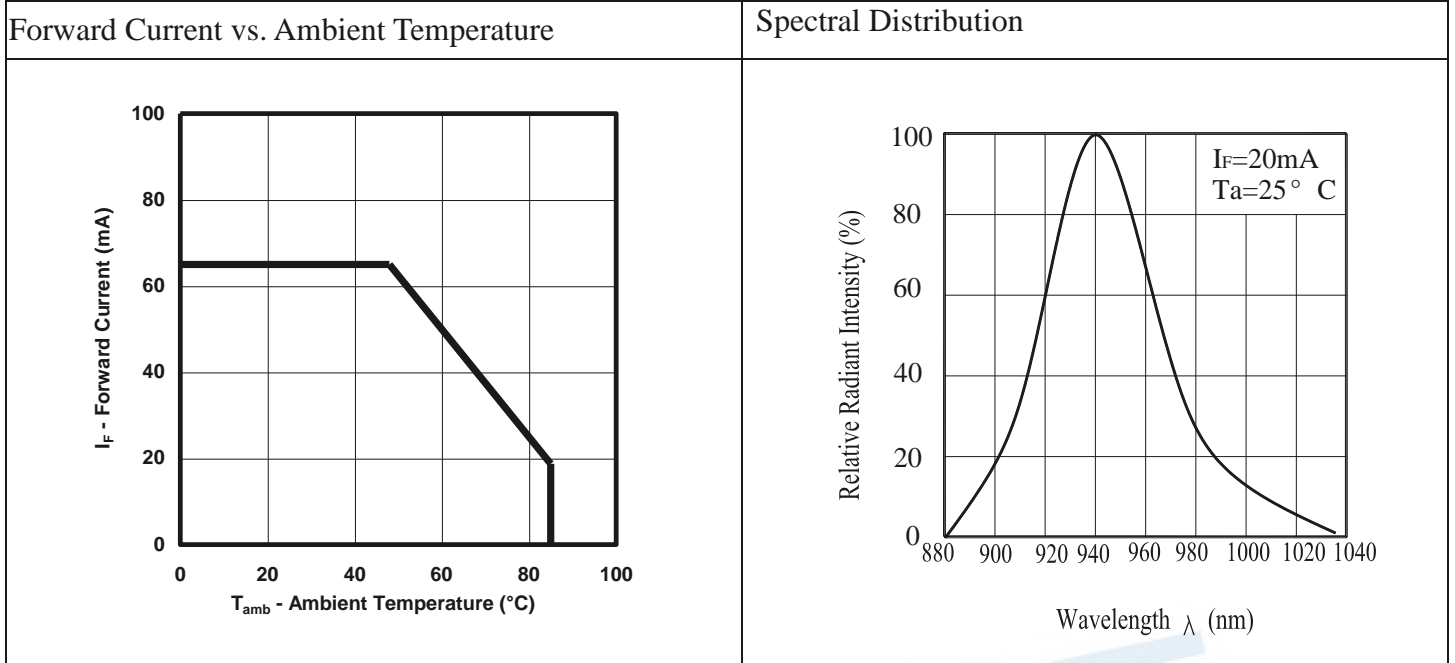

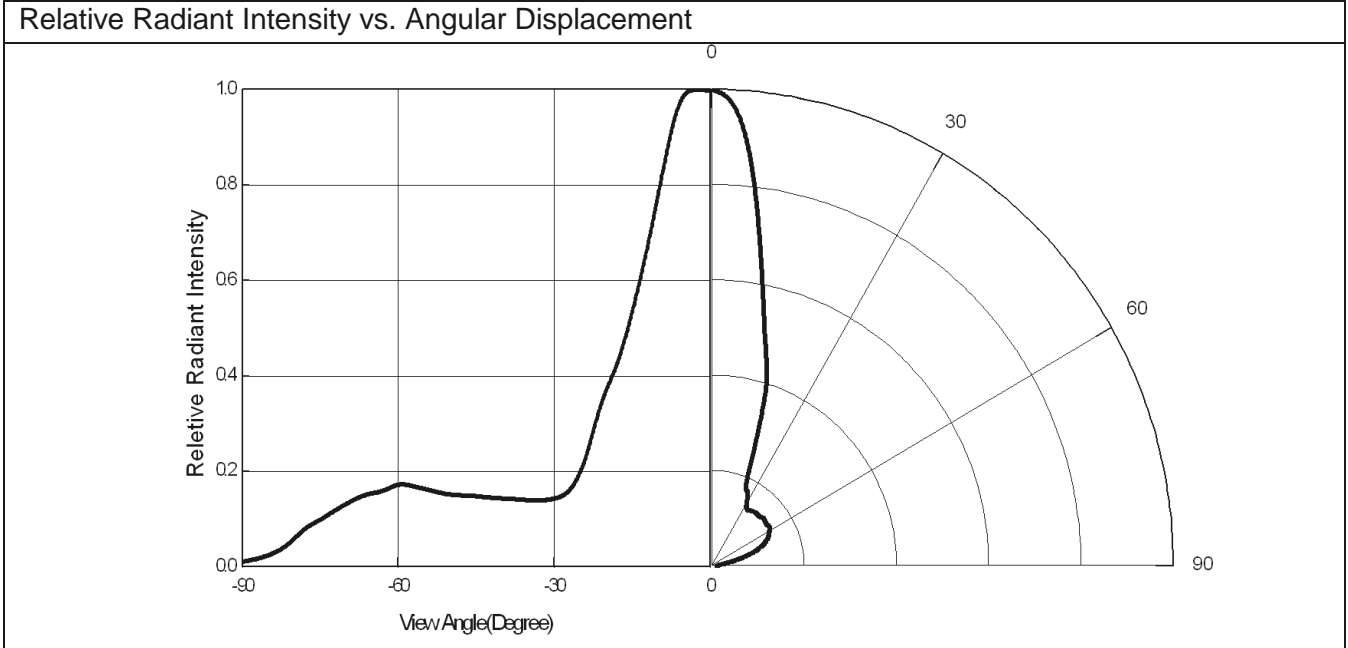

EVERLIGHT

## ● Precautions For Use

### 1. Over-current-proof

Customer must apply resistors for protection , otherwise slight voltage shift will cause big current change ( Burn out will happen ).

### 2. Storage

3.1 Do not open moisture proof bag before devices are ready to use.

3.2 Before opening the package, the LEDs should be kept at 30°C or less and 90%RH or less.

3.3 The LEDs should be used within a year.

3.4 After opening the package, the LEDs should be kept at 30°C or less and 60%RH or less.

3.5 The LEDs should be used within 168 hours (7 days) after opening the package

3.6 If the moisture absorbent material (silica gel) has faded away or the LEDs have exceeded the storage time, baking treatment should be performed using the following conditions.

Baking treatment : 60±5°C for Min 24 hours.

EVERLIGHT

3. Soldering Condition

4.1 Pb-free solder temperature profile

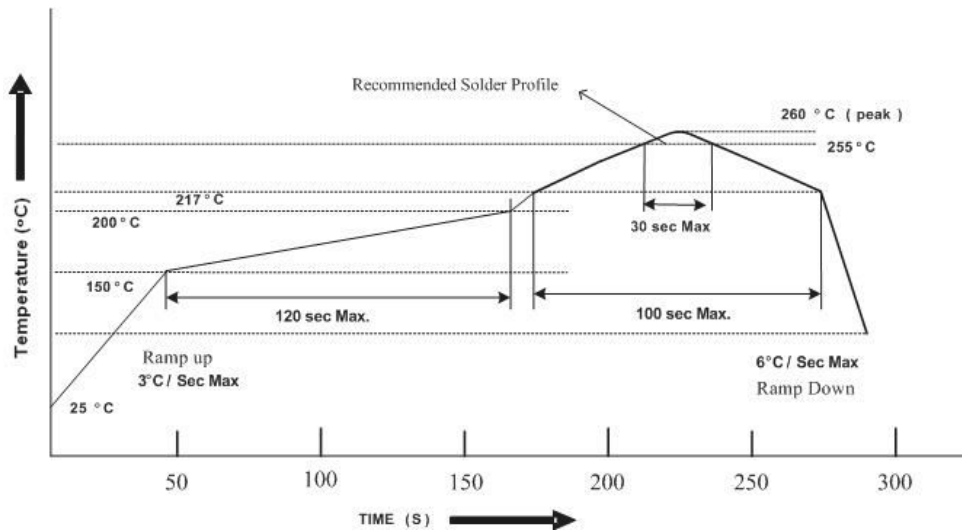

4.2 Reflow soldering should not be done more than two times.

4.3 When soldering, do not put stress on the LEDs during heating.

4.4 After soldering, do not warp the circuit board.

4. Soldering Iron

Each terminal is to go to the tip of soldering iron temperature less than 350°C for 3 seconds within once in less than the soldering iron capacity 25W. Leave two seconds and more intervals, and do soldering of each terminal. Be careful because the damage of the product is often started at the time of the hand solder.

5. Repairing

Repair should not be done after the LEDs have been soldered. When repairing is unavoidable, a double-head soldering iron should be used (as below figure). It should be confirmed beforehand whether the characteristics of the LEDs will or will not be damaged by repairing.

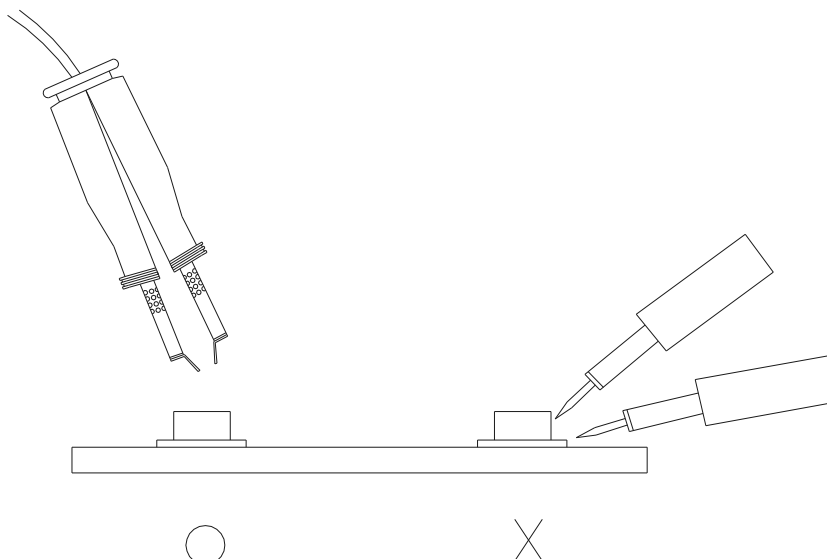

## Package Dimensions

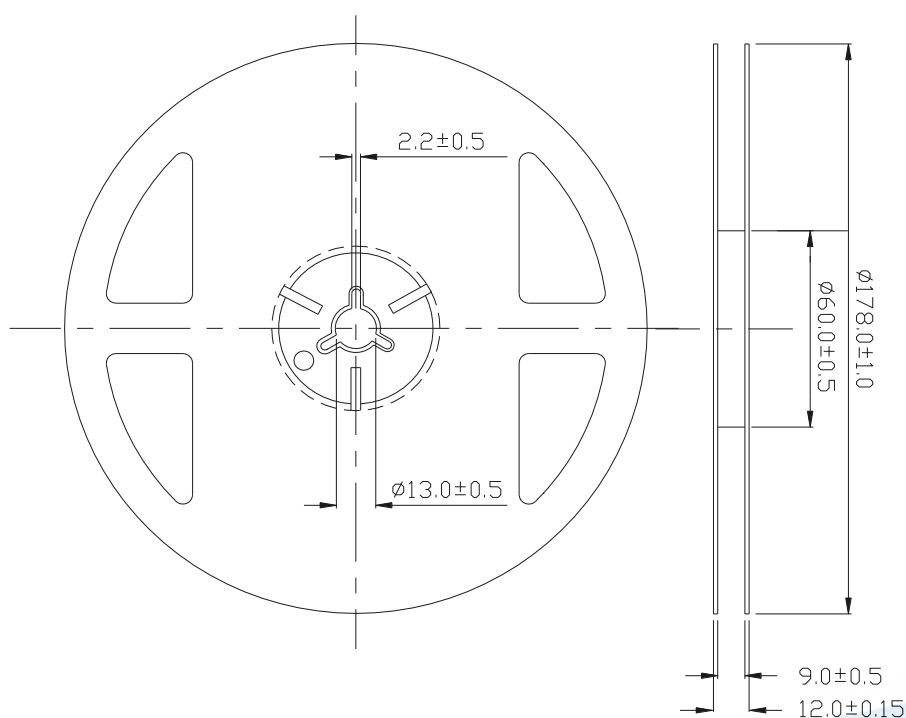

**Note:** The tolerances unless mentioned is  $\pm 0.1$ mm, Unit = mm

### 2. Carrier Tape Dimensions:(Quantity: 2000pcs/reel)

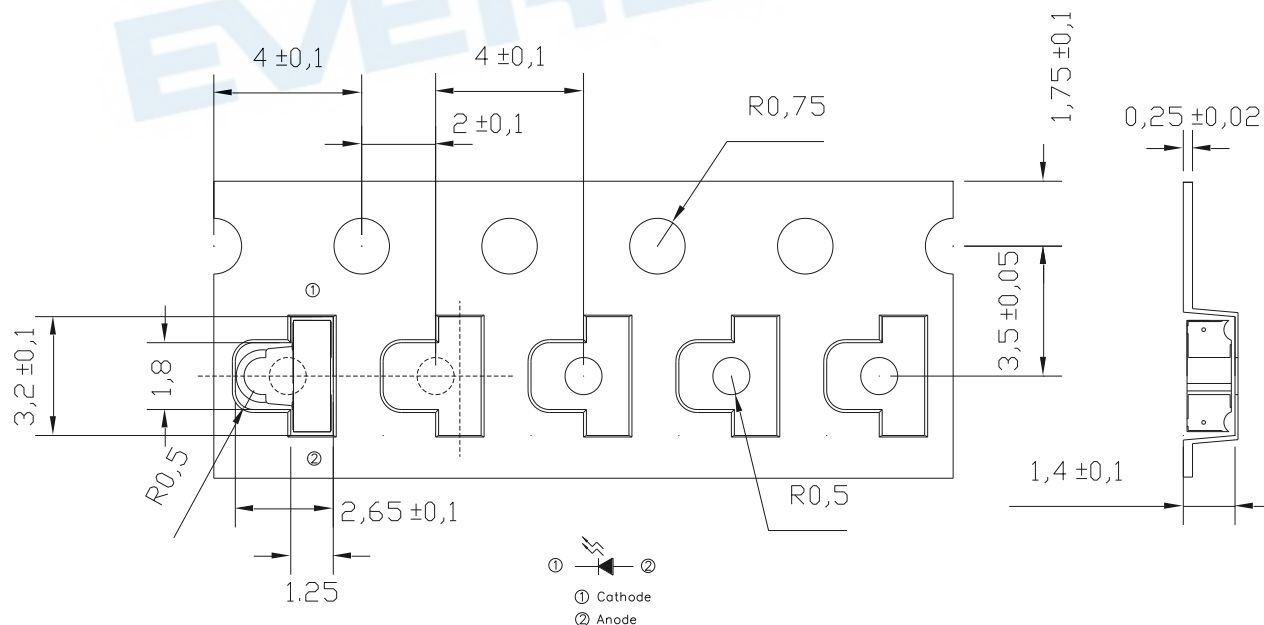

**Note:** The tolerances unless mentioned is  $\pm 0.1$ mm, Unit = mm



## Packing Procedure

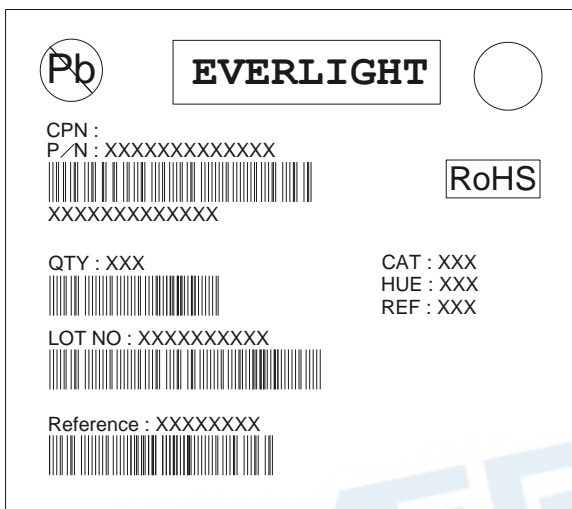
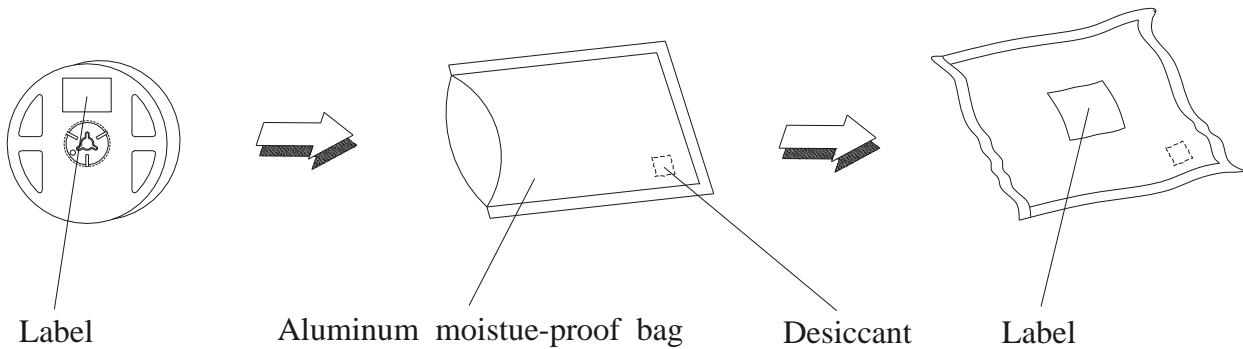

### Label Form Specification

CPN: Customer's Production Number

P/N : Production Number

QTY: Packing Quantity

CAT: Ranks

HUE: Peak Wavelength

REF: Reference

LOT No: Lot Number

MADE IN TAIWAN: Production Place

## Notes

1. Above specification may be changed without notice. EVERLIGHT will reserve authority on material change for above specification.
2. When using this product, please observe the absolute maximum ratings and the instructions for using outlined in these specification sheets. EVERLIGHT assumes no responsibility for any damage resulting from use of the product which does not comply with the absolute maximum ratings and the instructions included in these specification sheets.
3. These specification sheets include materials protected under copyright of EVERLIGHT corporation. Please don't reproduce or cause anyone to reproduce them without EVERLIGHT's consent.

## X-ON Electronics

Largest Supplier of Electrical and Electronic Components

*Click to view similar products for [Infrared Emitters](#) category:*

*Click to view products by [Everlight](#) manufacturer:*

Other Similar products are found below :

[LTE-3279K](#) [LTE-4208C](#) [LTE-2871C](#) [LTE-4238](#) [ASDL-4264-C22](#) [IR11-21CTR8](#) [EAIPL3528Z0](#) [OP216-004](#) [LTE-3376](#) [OSIXCA5B41A](#)  
[OSI5120631F](#) [IR234C](#) [LTE-C195IRG](#) [ZSIR-3210C-15A-C3](#) [ZSIR-3020C-23A-Z6](#) [IR333C-A\(BY\)\(P\)](#) [IR19-21C/TR8\(BY\)](#) [HIR26-](#)  
[21C/L423/CT\(XY\)](#) [IR928-6C/F1\(6-1\)](#) [IR423C/L10/F393\(AMZ\)\(PF\)](#) [EAISV3027A0](#) [HIR26-81B/L423/2T](#) [IR908-7C\(E5\)](#) [IR204-A-L\(BY\)\(M\)](#)  
[IR333C-A\(BY\)\(Q\)](#) [IR928-6C\(X8-X12\)\(XBY\)](#) [IR968-8C\(6-2\)](#) [IR204C-A-L\(BY\)\(M\)](#) [IR968-8C\(6-1\)](#) [XYC-HIR76C-LX0](#) [XYC-IRA3020A65-](#)  
[SX4](#) [XYC-HIR76C-LX4](#) [XYC-IRA3020A65-SX1](#) [DY-IRS302320C/6.5T](#) [DY-PTS3020268B-6.5TC](#) [DY-IR-8S302320C-6.5T](#) [DY-IR928-6C](#)  
[XL-504IRC-940](#) [XL-SD3036HIR-T202](#) [IR12-21C/TR8\(PF\)](#) [NCD3012I1](#) [NCD1005I1](#) [XYC-IR26C-LX4](#) [XYC-IR204C-L4](#) [XYC-IRC18C-24](#)  
[XYC-IR76C30-LX4](#) [XYC-IRA0805AC-S4](#) [XYC-HIRWC18C-Z2](#) [XYC-IRP0603AC-A2](#) [XYC-IRA2835A90-X4](#)