

Technical Data Sheet

5mm Infrared LED, T-1 3/4 IR333C-A(BY)



Features

- .High reliability
- .High radiant intensity
- .Peak wavelength $\lambda_p=940\text{nm}$
- .2.54mm Lead spacing
- .Low forward voltage
- .Pb free
- .This product itself will remain within RoHS compliant version.
 - Compliance with EU REACH
 - Compliance Halogen Free(Br < 900ppm, Cl < 900ppm, Br+Cl < 1500ppm)

Descriptions

EVERLIGHT's infrared emitting diode (IR333C-A(BY)) is a high intensity diode, molded in a water clear plastic package. The device is spectrally matched with phototransistor, photodiode and infrared receive module

Applications

- .Free air transmission system
- .Optoelectronic switch
- .Floppy disk drive
- .Infrared applied system
- .Smoke detector

Device Selection Guide

LED Part No.	Chip	Lens Color
	Material	
IR	GaAlAs	Water clear

Package Dimensions

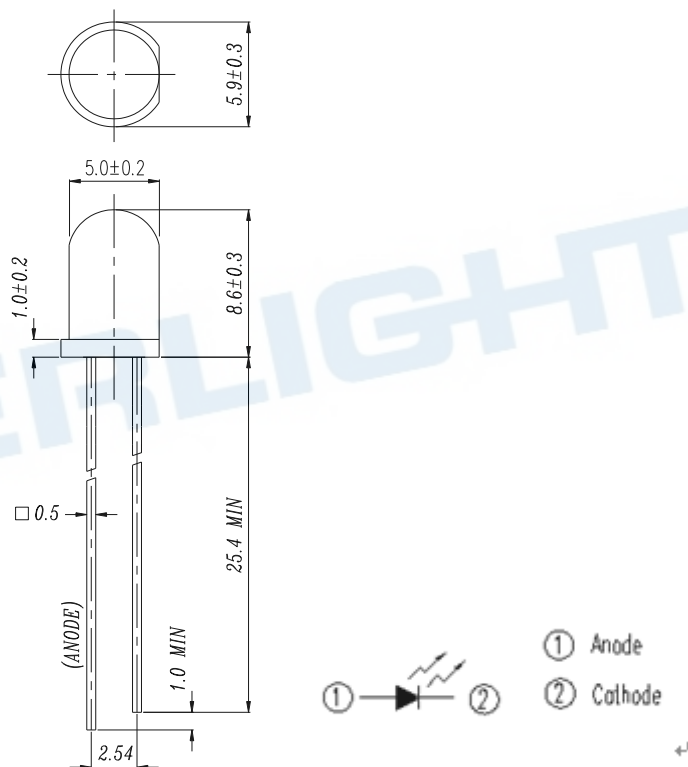

- Notes:**
- 1.All dimensions are in millimeters
 - 2.Tolerances unless dimensions $\pm 0.25\text{mm}$

Absolute Maximum Ratings (Ta=25°C)

Parameter	Symbol	Rating	Units
Continuous Forward Current	I _F	100	mA
Peak Forward Current *1	I _{FP}	1.0	A
Reverse Voltage	V _R	5	V
Operating Temperature	T _{opr}	-25~ +85	°C
Storage Temperature	T _{stg}	-40 ~ +100	°C
Soldering Temperature *2	T _{sol}	260	°C
Power Dissipation at(or below) 25°C Free Air Temperature	P _d	150	mW

Notes: *1:I_{FP} Conditions--Pulse Width ≤ 100μs and Duty ≤ 1%.

*2:Soldering time ≤ 10 seconds.

Electro-Optical Characteristics (Ta=25°C)

Parameter	Symbol	Condition	Min.	Typ.	Max.	Units
Radiant Intensity	I _e	I _F =20mA	7.8	20	--	mW/sr
		I _F =100mA Pulse Width ≤ 100μs and Duty ≤ 1%	--	100	--	
		I _F =1A Pulse Width ≤ 100μs and Duty ≤ 1%	--	1000	--	
Peak Wavelength	λ _p	I _F =20mA	--	940	--	nm
Spectral Bandwidth	Δλ	I _F =20mA	--	45	--	nm
Forward Voltage	V _F	I _F =20mA	--	1.2	1.5	V
		I _F =100mA Pulse Width ≤ 100μs and Duty ≤ 1%	--	1.4	1.7	
		I _F =1A Pulse Width ≤ 100μs and Duty ≤ 1%	--	2.6	4.0	
Reverse Current	I _R	V _R =5V	--	--	10	μA
View Angle	2θ _{1/2}	I _F =20mA	--	20	--	deg

Rank

Condition: $I_F=20\text{mA}$

Unit: mW/sr

Bin Number	M	N	P	Q	R
Min	7.8	11.0	15.0	21.0	30.0
Max	12.5	17.6	24.0	34.0	48.0

Note:

*Measurement Uncertainty of Forward Voltage: $\pm 0.1\text{V}$

*Measurement Uncertainty of Luminous Intensity: $\pm 10\%$

*Measurement Uncertainty of Dominant Wavelength $\pm 1.0\text{nm}$

Typical Electro-Optical Characteristics Curves

Fig.1 Forward Current vs.
Ambient Temperature

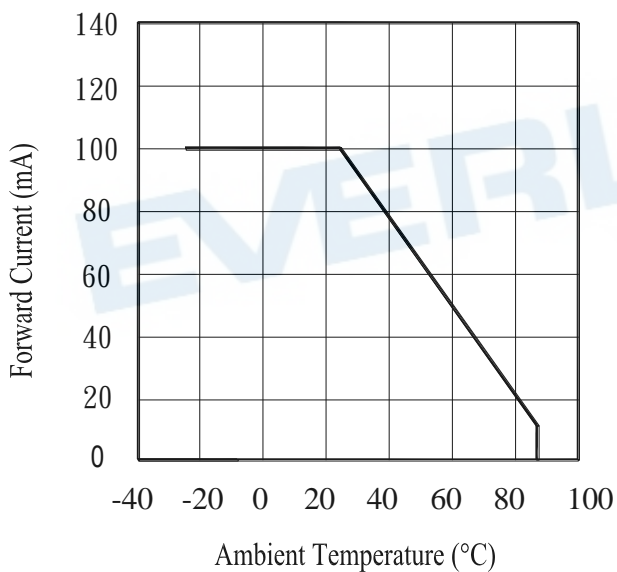

Fig.2 Spectral Distribution

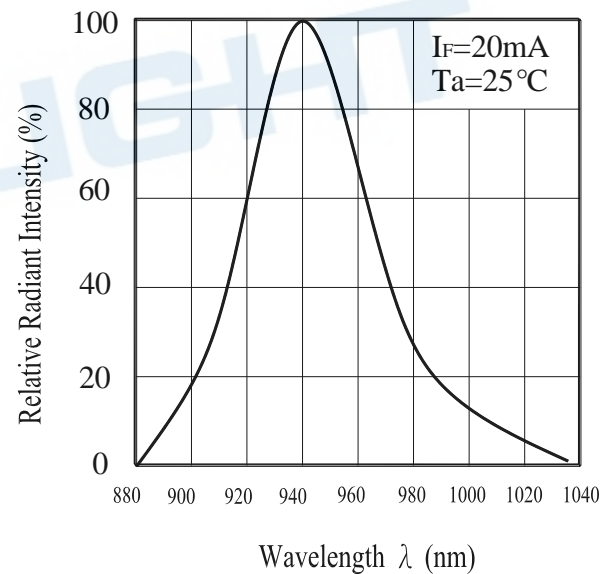

Fig.3 Peak Emission Wavelength vs. Ambient Temperature

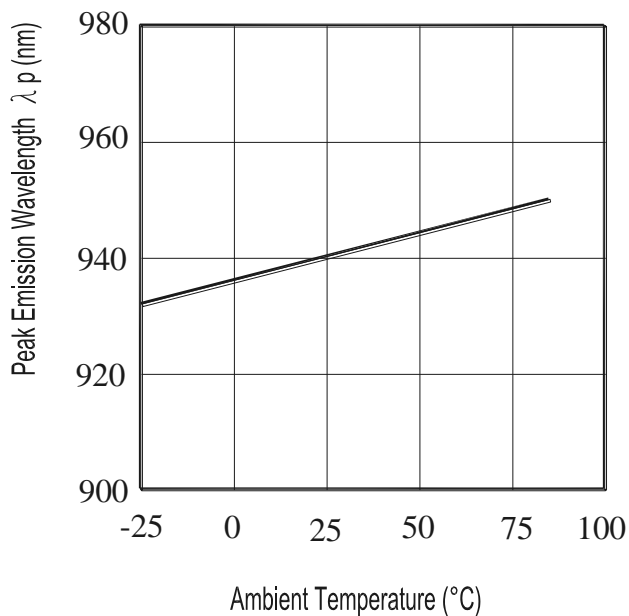
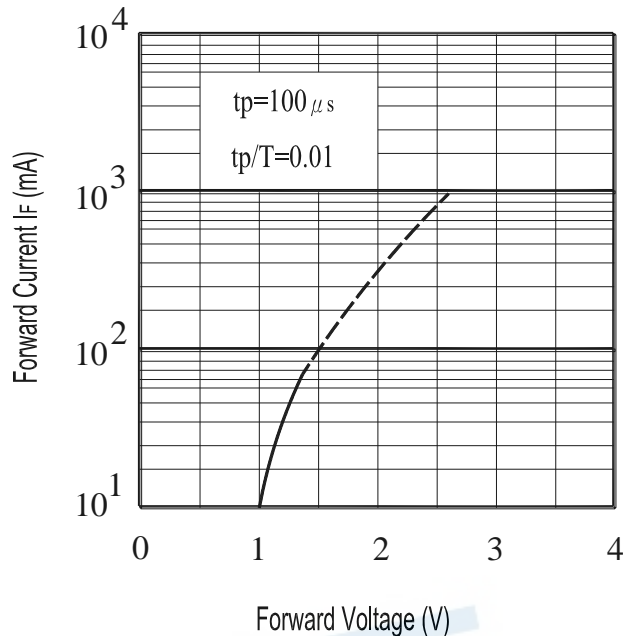

Fig.4 Forward Current vs. Forward Voltage



Typical Electro-Optical Characteristics Curves

Fig.5 Radiant Intensity vs. Forward Current

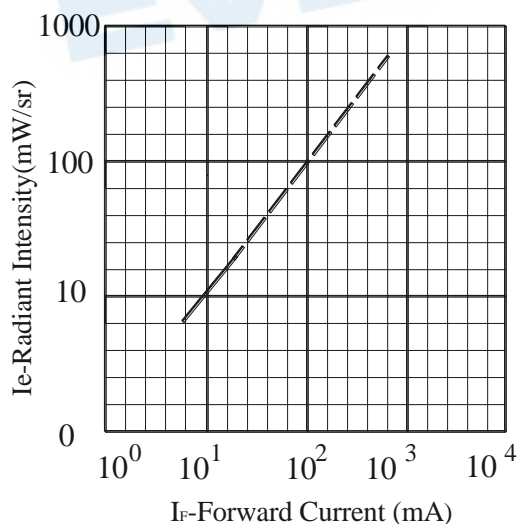
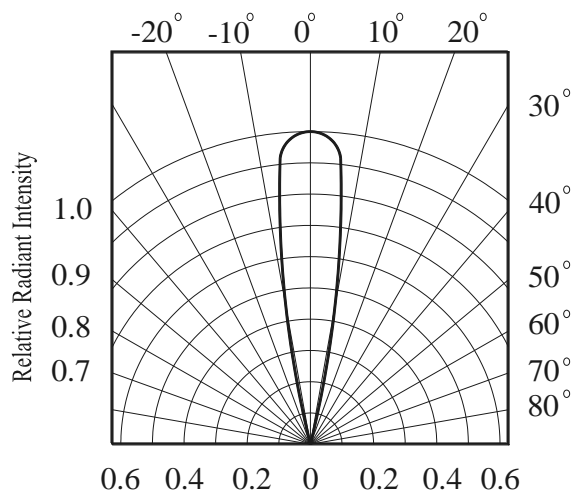

Fig.6 Relative Radiant Intensity vs. Angular Displacement



Packing Quantity Specification

1.200~500PCS/1Bag,5Bags/1Box

2.10Boxes/1Carton

Label Form Specification

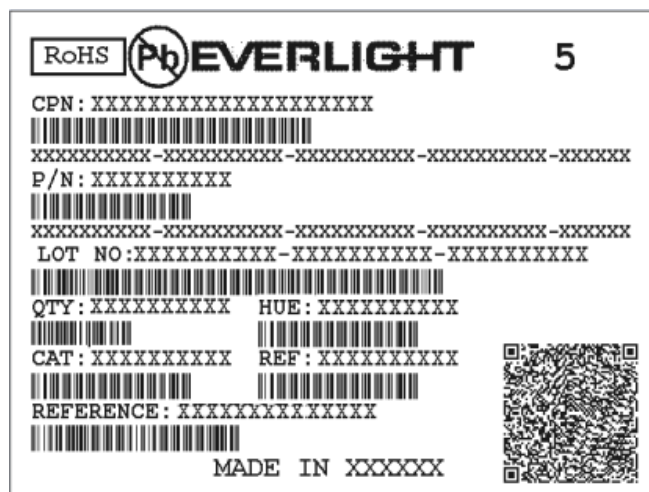

CPN: Customer's Production Number

P/N : Production Number

QTY: Packing Quantity

CAT: Ranks

HUE: Peak Wavelength

REF: Reference

LOT No: Lot Number

X: Month

Reference: Identify Label Number

Notes

1. Lead Forming

- During lead formation, the leads should be bent at a point at least 3mm from the base of the epoxy bulb.
- Lead forming should be done before soldering.
- Avoid stressing the PHOTOTRANSISTORS. package during leads forming. The stress to the base may damage the LED's characteristics or it may break the PHOTOTRANSISTORS.
- Cut the PHOTOTRANSISTORS lead frames at room temperature. Cutting the lead frames at high temperatures may cause failure of the PHOTOTRANSISTORS.
- When mounting the PHOTOTRANSISTORS. onto a PCB, the PCB holes must be aligned exactly with the lead position of the PHOTOTRANSISTORS.. If the LEDs are mounted with stress at the leads, it causes deterioration of the epoxy resin and this will degrade the PHOTOTRANSISTORS..

2. Storage

- The PHOTOTRANSISTORS. should be stored at 30°C or less and 70%RH or less after being shipped from Everlight and the storage life limits are 3 months. If the PHOTOTRANSISTORS. are stored for 3 months or more, they can be stored for a year in a sealed container with a nitrogen atmosphere and moisture absorbent material.
- Please avoid rapid transitions in ambient temperature, especially, in high humidity environments where condensation can occur.

3. Soldering

- Careful attention should be paid during soldering. When soldering, leave more than 3mm from solder joint to

epoxy bulb, and soldering beyond the base of the tie bar is recommended.

- Recommended soldering conditions:

Hand Soldering		DIP Soldering	
Temp. at tip of iron	300°C Max. (30W Max.)	Preheat temp.	100°C Max. (60 sec Max.)
Soldering time	3 sec Max.	Bath temp. & time	260 Max., 5 sec Max
Distance	3mm Min.(From solder joint to epoxy bulb)	Distance	3mm Min. (From solder joint to epoxy bulb)

- Recommended soldering profile

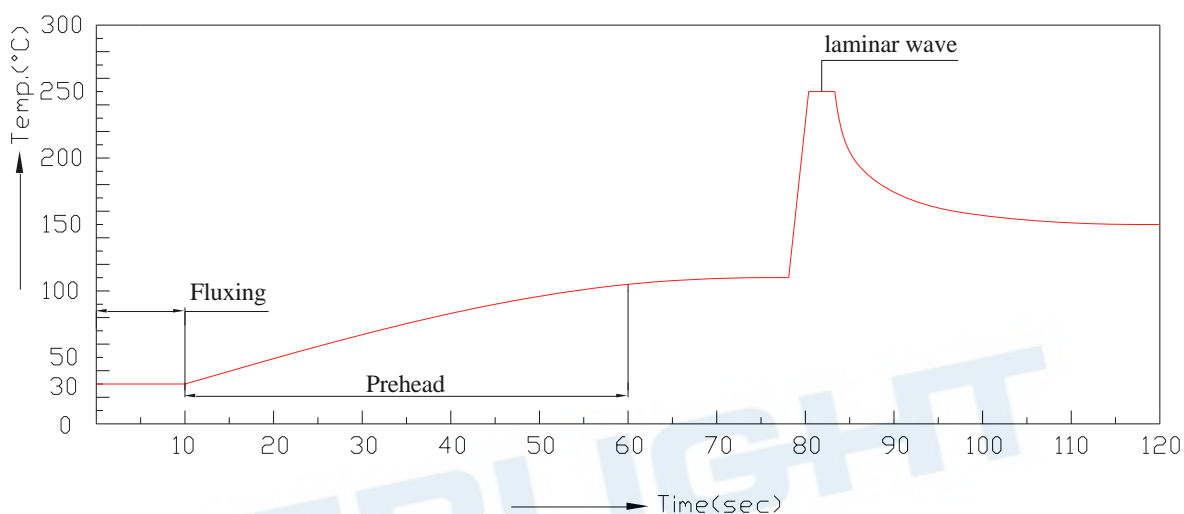

- Avoiding applying any stress to the lead frame while the PHOTOTRANSISTORS are at high temperature particularly when soldering.
- Dip and hand soldering should not be done more than one time
- After soldering the PHOTOTRANSISTORS, the epoxy bulb should be protected from mechanical shock or vibration until the PHOTOTRANSISTORS return to room temperature.
- A rapid-rate process is not recommended for cooling the PHOTOTRANSISTORS down from the peak temperature.

Although the recommended soldering conditions are specified in the above table, dip or hand soldering at the lowest

possible temperature is desirable for the PHOTOTRANSISTORS..

- Wave soldering parameter must be set and maintain according to recommended temperature and dwell time in the solder wave.

4. Cleaning

- When necessary, cleaning should occur only with isopropyl alcohol at room temperature for a duration of no more than one minute. Dry at room temperature before use.
- Do not clean the PHOTOTRANSISTORS by the ultrasonic. When it is absolutely necessary, the influence

of ultrasonic cleaning on the PHOTOTRANSISTORS. depends on factors such as ultrasonic power and the assembled condition. Ultrasonic cleaning shall be pre-qualified to ensure this will not cause damage to the PHOTOTRANSISTORS.

5. Heat Management

- Heat management of PHOTOTRANSISTORS. must be taken into consideration during the design stage of PHOTOTRANSISTORS. application. The current should be de-rated appropriately by referring to the de-rating curve found in each product specification.
- The temperature surrounding the PHOTOTRANSISTORS. in the application should be controlled. Please refer to the data sheet de-rating curve.

6. ESD (Electrostatic Discharge)

- Electrostatic discharge (ESD) or surge current (EOS) can damage PHOTOTRANSISTORS..
- An ESD wrist strap, ESD shoe strap or antistatic gloves must be worn whenever handling PHOTOTRANSISTORS..
- All devices, equipment and machinery must be properly grounded.
- Use ion blower to neutralize the static charge which might have built up on surface of the LEDs plastic lens as a result of friction between PHOTOTRANSISTORS. during storage and handing.

DISCLAIMER

1. EVERLIGHT reserves the right(s) on the adjustment of product material mix for the specification.
2. The product meets EVERLIGHT published specification for a period of twelve (12) months from date of shipment.
3. The graphs shown in this datasheet are representing typical data only and do not show guaranteed values.
4. When using this product, please observe the absolute maximum ratings and the instructions for using outlined in these specification sheets. EVERLIGHT assumes no responsibility for any damage resulting from the use of the product which does not comply with the absolute maximum ratings and the instructions included in these specification sheets.
5. These specification sheets include materials protected under copyright of EVERLIGHT. Reproduction in any form is prohibited without obtaining EVERLIGHT's prior consent.
6. This product is not intended to be used for military, aircraft, automotive, medical, life sustaining or life saving applications or any other application which can result in human injury or death. Please contact authorized Everlight sales agent for special application request.

X-ON Electronics

Largest Supplier of Electrical and Electronic Components

Click to view similar products for [Infrared Emitters](#) category:

Click to view products by [Everlight](#) manufacturer:

Other Similar products are found below :

[LTE-3279K](#) [LTE-4208C](#) [LTE-2871C](#) [LTE-4238](#) [ASDL-4264-C22](#) [IR11-21CTR8](#) [EAIPL3528Z0](#) [OP216-004](#) [LTE-3376](#) [OSIXCA5B41A](#)
[OSI5120631F](#) [IR234C](#) [LTE-C195IRG](#) [ZSIR-3210C-15A-C3](#) [ZSIR-3020C-23A-Z6](#) [IR333C-A\(BY\)\(P\)](#) [IR19-21C/TR8\(BY\)](#) [HIR26-](#)
[21C/L423/CT\(XY\)](#) [IR928-6C/F1\(6-1\)](#) [IR423C/L10/F393\(AMZ\)\(PF\)](#) [EAISV3027A0](#) [HIR26-81B/L423/2T](#) [IR908-7C\(E5\)](#) [IR204-A-L\(BY\)\(M\)](#)
[IR333C-A\(BY\)\(Q\)](#) [IR928-6C\(X8-X12\)\(XBY\)](#) [IR968-8C\(6-2\)](#) [IR204C-A-L\(BY\)\(M\)](#) [IR968-8C\(6-1\)](#) [XYC-HIR76C-LX0](#) [XYC-IRA3020A65-](#)
[SX4](#) [XYC-HIR76C-LX4](#) [XYC-IRA3020A65-SX1](#) [DY-IRS302320C/6.5T](#) [DY-PTS3020268B-6.5TC](#) [DY-IR-8S302320C-6.5T](#) [DY-IR928-6C](#)
[XL-504IRC-940](#) [XL-SD3036HIR-T202](#) [IR12-21C/TR8\(PF\)](#) [NCD3012I1](#) [NCD1005I1](#) [XYC-IR26C-LX4](#) [XYC-IR204C-L4](#) [XYC-IRC18C-24](#)
[XYC-IR76C30-LX4](#) [XYC-IRA0805AC-S4](#) [XYC-HIRWC18C-Z2](#) [XYC-IRP0603AC-A2](#) [XYC-IRA2835A90-X4](#)