



Technical Data Sheet

Infrared LED

Features :

- Low forward voltage
- Peak wavelength $\lambda_p=940\text{nm}$
- High reliability • Fast response time
- Pb free
- The product itself will remain within RoHS compliant version.

IR908-7C

Description :

The IR908-7C is a GaAs(GaAlAs) infrared emitting diode. The miniature side-facing device has a chip that emits radiation from the side of the clear package.

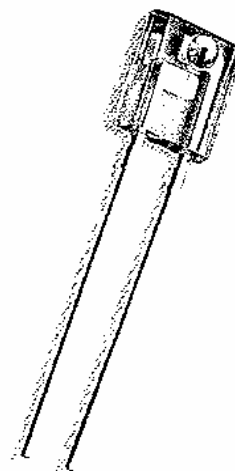

Applications :

- Mouse
- Optoelectronic Switch
- Photo Interrupter

Device Selection Guide :

LED Part No.	Chip	Lens Color
	Material	
IR	GaAlAs	Clear

Device No:DIR-090-106

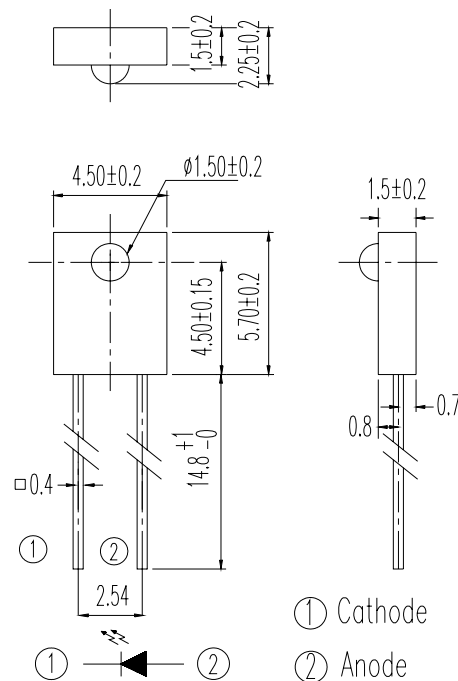
Package Dimensions :

Notes : All dimensions are in millimeters.

Absolute Maximum Ratings (Ta=25°C)

Parameter	Symbol	Rating	Units
Power Dissipation	P_D	75	MW
Reverse Voltage	V_R	5	V
Forward Current	I_F	50	MA
Peak Forward Current ^{*1}	I_{FP}	1	A
Operating Temperature	Topr	-25~+85	°C
Storage Temperature	Tstg	-40~+85	°C
Soldering Temperature ^{*2}	Tsol	260	°C

Notes:*1: I_{FP} Condition—Pulse Width ≤ 10 msec and Duty $\leq 1/10$

*2: Soldering time ≤ 5 seconds

**Electronic Optical Characteristics :**

Parameter	Symbol	Min.	Typ.	Max.	Unit	Condition
Light Current	$I_{C(ON)}$	140	--	1300	μA	$I_F=4mA, V_{CE}=3.5V$
Peak Wavelength	λ_p	--	940	--	nm	$I_F=20mA$
Spectral Bandwidth	$\Delta \lambda$	--	80	--	nm	$I_F=20mA$
View angle	$2\Theta_{1/2}$	--	60	--	Deg	$I_F=20mA$
Forward Voltage	V_F	--	1.2	1.6	V	$I_F=20mA$
Reverse Current	I_R	--	--	10	μA	$V_R=5V$

Ranks

E Ranks

Color Code	Parameter	Min	Max	Unit
Red	E1	140	260	μA
Blue	E2	210	350	μA
Yellow	E3	280	440	μA
Silver	E4	350	530	μA
Green	E5	420	620	μA
Purple	E6	490	710	μA
White	E7	560	800	μA
Brown	E8	630	890	μA
Orange	E9	700	980	μA

Notes: Test condition: $I_F=4 mA, V_{CE}=3.5V$

Rough Ranks

Color Code	Parameter	Min	Max	Unit
Blue	7-2	300	450	μA
Yellow	7-1	340	520	μA
Silver	6-2	490	750	μA
Green	6-1	650	1300	μA

Notes: Test condition: $I_F=4 mA, V_{CE}=3.5V$

Typical Electrical-Optical Characteristics Curves

Fig.1 Forward Current vs. Ambient Temperature

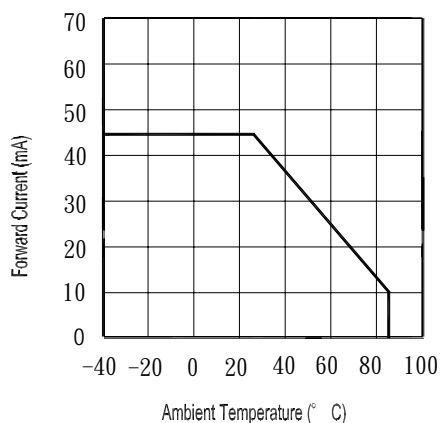

Fig.2 Spectral Distribution

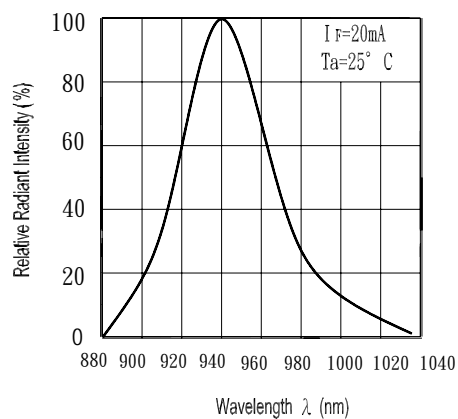

Fig.3 Peak Emission Wavelength vs. Ambient Temperature

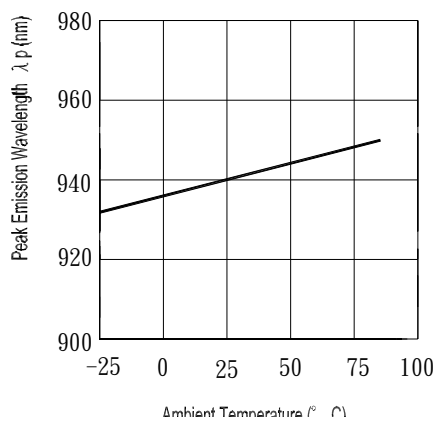

Fig.4 Forward Current vs. Forward Voltage

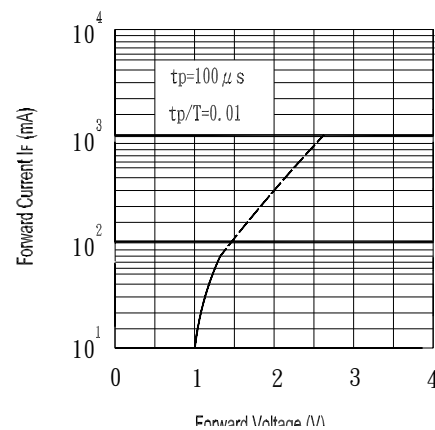

Fig.5 Forward Current vs. Ambient Temperature (°C)

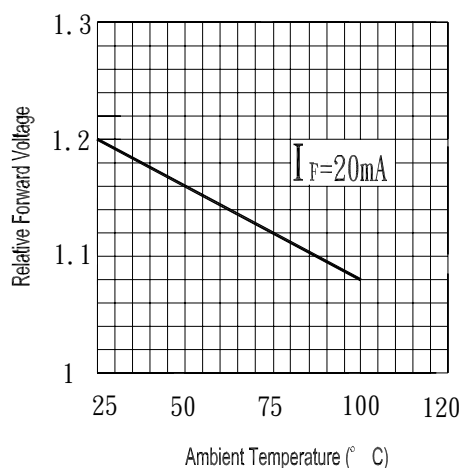
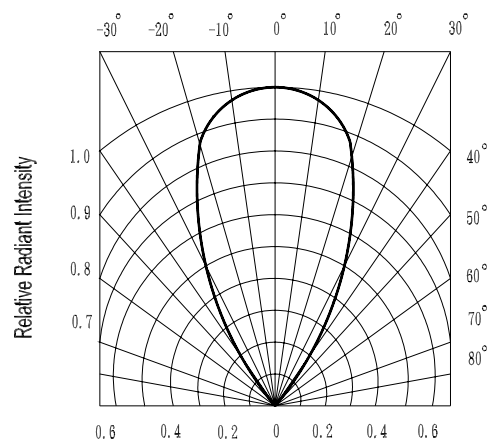
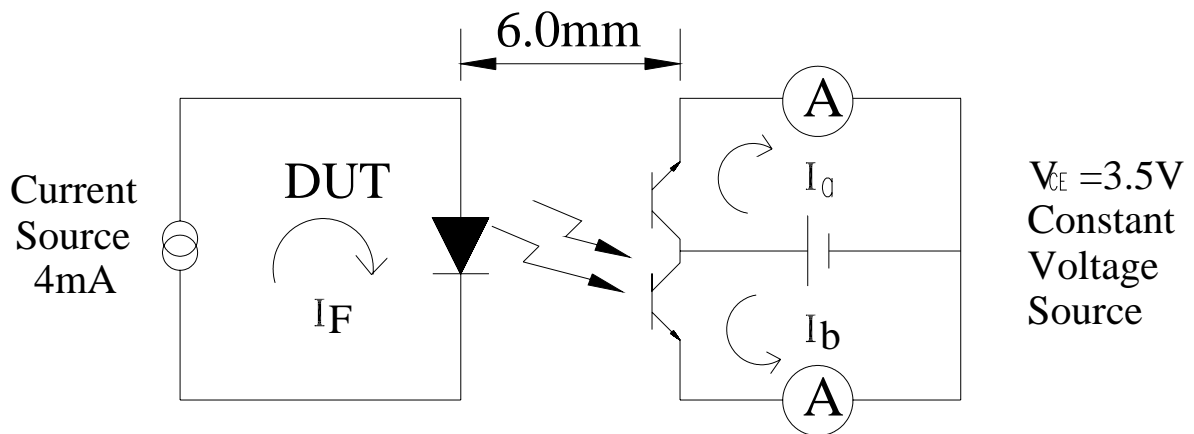

Fig.6 Relative Radiant Intensity vs. Angular Displacement



Test Method

EVERLIGHT ELECTRONICS CO., LTD.
Office: No 25, Lane 76, Sec 3, Chung Yang Rd,
Tucheng, Taipei 236, Taiwan, R.O.C

Tel: 886-2-2267-2000, 2267-9936
Fax: 886-2267-6244, 2267-6189, 2267-6306
<http://www.everlight.com>

Device No:DIR-090-106

X-ON Electronics

Largest Supplier of Electrical and Electronic Components

Click to view similar products for [Everlight manufacturer](#):

Other Similar products are found below :

[QTLP600C4TR](#) [EL-17-21SURC/S530-A2/TR8](#) [19-213UYC/S530-A2/TR8](#) [QTLP651C4TR](#) [MAN6760](#) [ELSW-F41Y1-OLPNM-AA3A5](#)
[HLMPM501](#) [ITR-20002](#) [11-21SURC-S530-A3-TR8](#) [SIR67-21/TR8](#) [SIR91-21C/TR10](#) [HLMP4740](#) [PT42-21B-TR8](#) [ELSW-F71M1-0CPHS-](#)
[C3000](#) [MV64521](#) [EL816\(B\)\(ETN\)-F](#) [48-213/Y2C-AM2P1BY/3C](#) [11-21/T3D-AQ1R1QY/2T](#) [HLMP1301](#) [MV53123](#) [EL817M\(B\)\(TH\)-F](#) [11-](#)
[21USOC/S530-A2/TR8](#) [12-215/BHC-YLMQY/3C](#) [15-215/Y5C-AP2R1L/2T](#) [23-23B/R6GHBHC-A30/2T](#) [PT334-6B-52](#) [HLMP1440](#) [ELSH-](#)
[F41R1-OLPNM-AR5R6](#) [EL1017\(TA\)-VG](#) [QTLP600C2TR](#) [27-21/GHC-YR2T1/3C](#) [IRM-3638MF56](#) [MV5354A](#) [EL2601](#) [6N137M](#) [PT204-6C](#)
[PT204-6B-27](#) [23-21SURC/S530-A3/TR8](#) [19-217UTD/S756-3/TR8](#) [15-215SYGC/S530-E1/TR8](#) [IR333/H0-A](#) [IRM-3638M3F99-E80](#) [12-](#)
[21CSUBP/S576/TR8](#) [15-21SYGC/S530-E1/TR8](#) [CNY17F-2](#) [EL3H7-G](#) [28-21SYGC/S530-E2/TR8](#) [4N37](#) [19-213/T1D-KS1T1B2/3T/EU](#) [12-](#)
[21/Y2C-HP1Q1/2C](#)