

Sidelooker Infrared LED IR928-6C(X8-X12)(XBY)



Features

- High reliability
- High radiant intensity
- Peak wavelength $\lambda_p=940\text{nm}$
- 2.54mm lead spacing
- Low forward voltage
- Pb free
- This product itself will remain within RoHS compliant version.

Description

- EVERLIGHT's Infrared emitting diode IR928-6C(X8-X12)(XBY) is a high intensity diode, molded in a water clear plastic package.
- The miniature side-facing device has a chip, that emits radiation from the side of the clear package.

Applications

- Mouse
- Optoelectronic switch
- Infrared applied system

Device Selection Guide

Part Category	Chip Material	Lens Color
IR	GaAs	Water Clear

Package Dimension

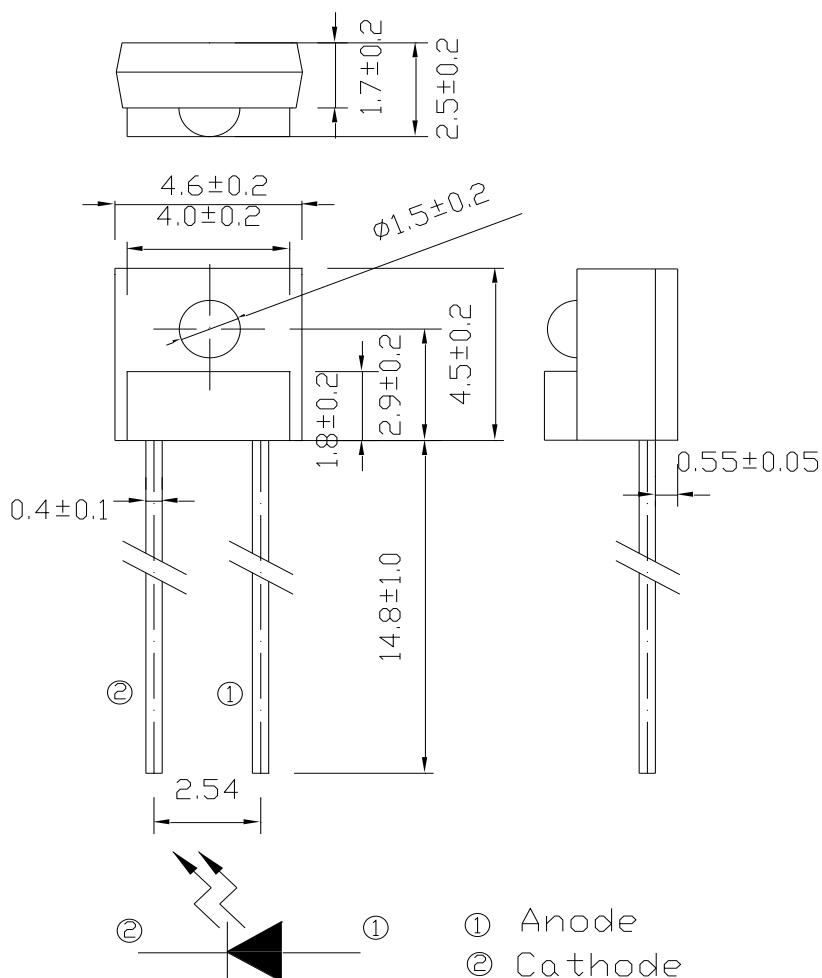

- Notes: 1. All dimensions are in millimeters
 2. Tolerances unless dimensions $\pm 0.3\text{mm}$

Absolute Maximum Ratings ($T_a=25^\circ\text{C}$)

Parameter	Symbol	Rating	Units
Continuous Forward Current	I_F	50	mA
Reverse Voltage	V_R	5	V
Operating Temperature	T_{opr}	-25 ~ +85	$^\circ\text{C}$
Storage Temperature	T_{stg}	-40 ~ +85	$^\circ\text{C}$
Soldering Temperature *1	T_{sol}	260	$^\circ\text{C}$
Power Dissipation at (or below) 25 $^\circ\text{C}$ Free Air Temperature	P_d	75	mW

Notes: *1. Soldering time ≤ 5 seconds.

Electro-Optical Characteristics (Ta=25°C)

Parameter	Symbol	Condition	Min.	Typ.	Max.	Units
Light Current	$I_{C(ON)}$	$I_F=4mA, V_{CE}=3.5V$	650	--	1870	μA
Peak Wavelength	λ_p	$I_F=20mA$	--	940	--	nm
Spectral Bandwidth	$\Delta\lambda$	$I_F=20mA$	--	50	--	nm
Forward Voltage	V_F	$I_F=20mA$	--	1.25	1.60	V
Reverse Current	I_R	$V_R=5V$	--	--	10	μA
View Angle	2 θ 1/2	$I_F=20mA$	--	20	--	deg

Rank

Condition: $I_F=4mA, V_{CE}=3.5V$

Symbol	Condition	Ranks	Min.	Max.	Unit
$I_{C(ON)}$	$I_F=4mA$ $V_{CE}=3.5V$	X8	650	915	μA
		X9	747	1034	
		X10	846	1154	
		X11	944	1274	
		X12	1043	1870	

Notes: This bin table is only for reference, not for specific bin shipment.

Test Method For $I_{C(ON)}$:

Condition: $I_F=4mA, V_{CE}=3.5V$

The intensity testing method for infrared emitting diode

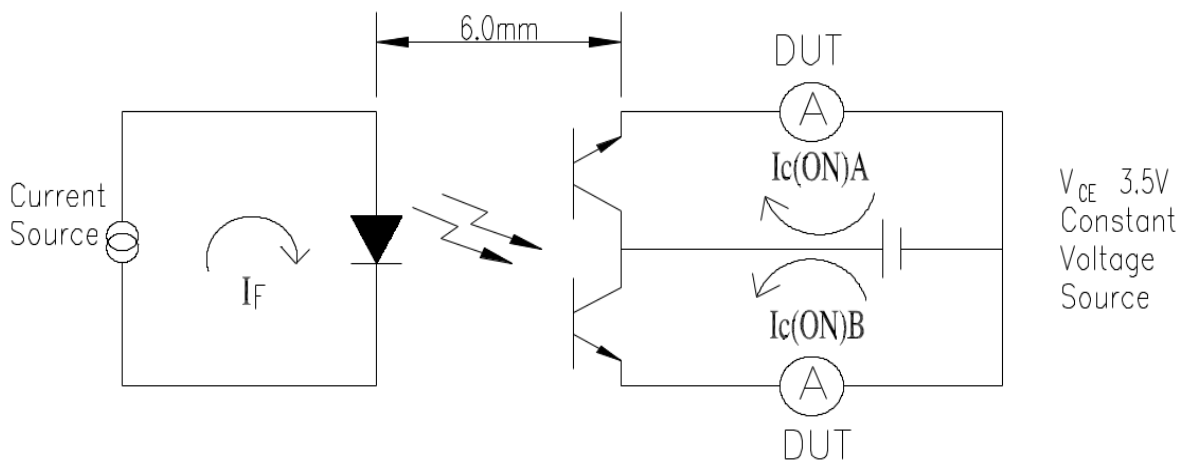

Typical Electro-Optical Characteristics Curves

Fig.1 Forward Current vs. Ambient Temperature

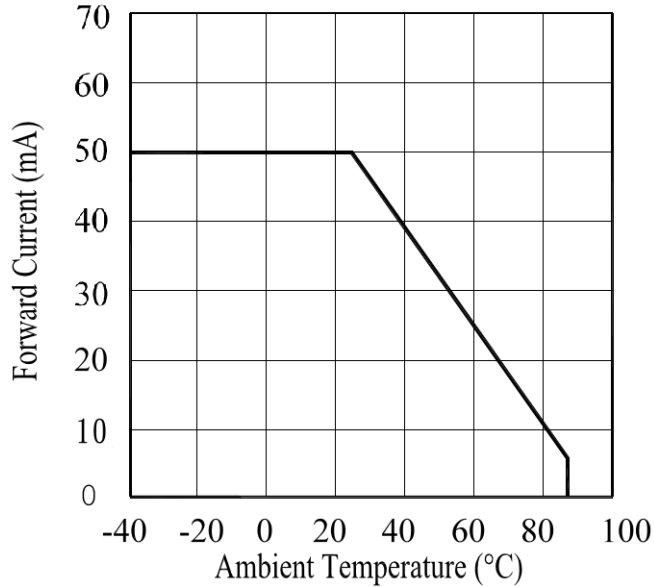

Fig.2 Spectral Distribution

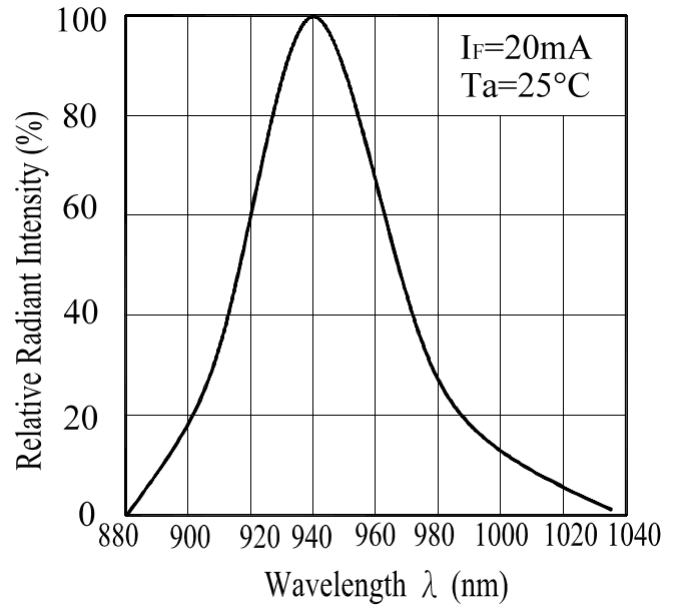

Fig.3 Forward Current vs. Forward Voltage

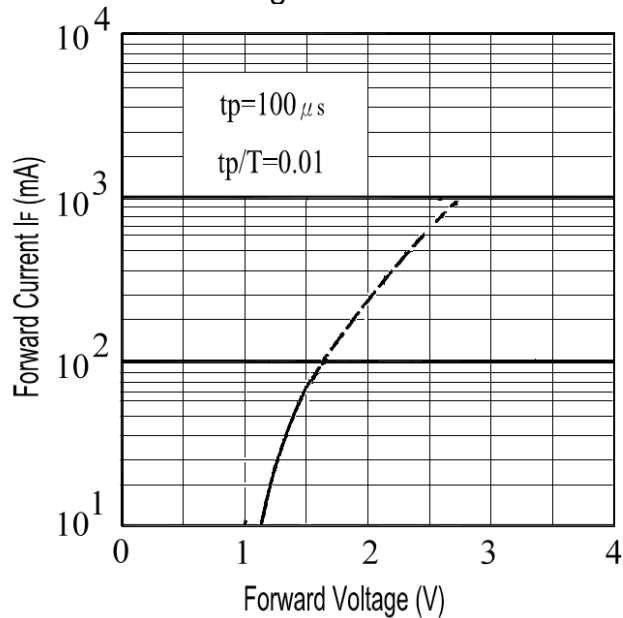
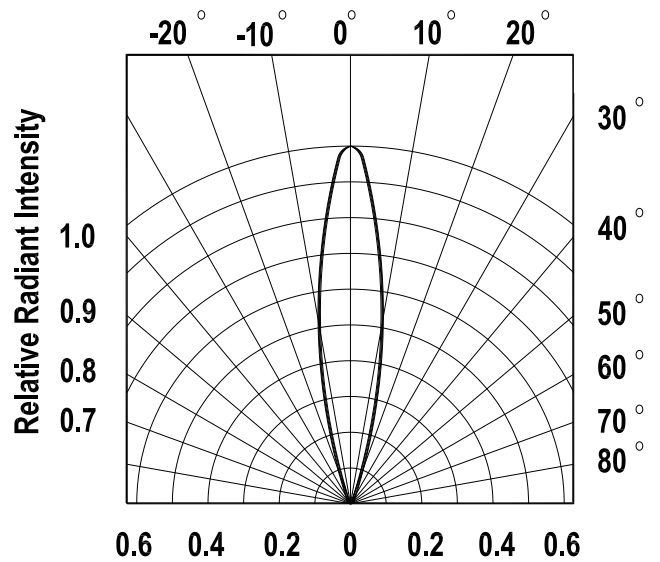

Fig.4 Relative Radiant Intensity vs. Angular Displacement



Packing Quantity Specification

1000 pcs/bag, 8 bags/box
10 boxes/carton

Label Form Specification

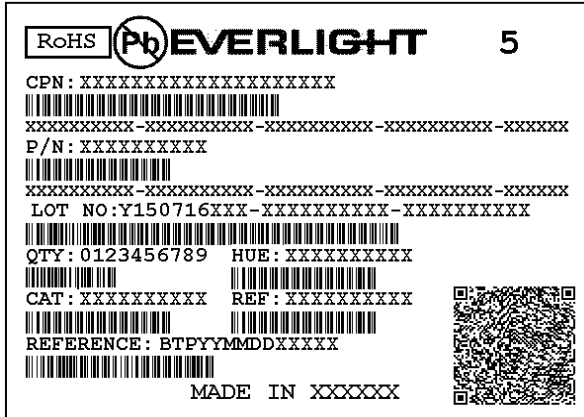

- CPN: Customer Part Number
- P/N: Part Number
- QTY: Packing Quantity
- CAT: Ranks
- HUE: Peak Wavelength
- REF: Reference
- LOT No: Lot Number

Application Restrictions

1. Above specification may be changed without notice. EVERLIGHT will reserve authority on material change for above specification.
2. The graphs shown in this datasheet are representing typical data only and do not show guaranteed values.
3. When using this product, please observe the absolute maximum ratings and the instructions for use outlined in these specification sheets. EVERLIGHT assumes no responsibility for any damage resulting from use of the product which does not comply with the absolute maximum ratings and the instructions included in these specification sheets.
4. These specification sheets include materials protected under copyright of EVERLIGHT. Reproduction in any form is prohibited without the specific consent of EVERLIGHT.
5. This product is not intended to be used for military, aircraft, automotive, medical, life sustaining or life saving applications or any other application which can result in human injury or death. Please contact authorized Everlight sales agent for special application request.

X-ON Electronics

Largest Supplier of Electrical and Electronic Components

Click to view similar products for [Infrared Emitters](#) category:

Click to view products by [Everlight](#) manufacturer:

Other Similar products are found below :

[LTE-3279K](#) [LTE-4208C](#) [LTE-2871C](#) [LTE-4238](#) [ASDL-4264-C22](#) [IR11-21CTR8](#) [EAIPL3528Z0](#) [OP216-004](#) [LTE-3376](#) [OSIXCA5B41A](#)
[OSI5120631F](#) [IR234C](#) [LTE-C195IRG](#) [ZSIR-3210C-15A-C3](#) [ZSIR-3020C-23A-Z6](#) [IR333C-A\(BY\)\(P\)](#) [IR19-21C/TR8\(BY\)](#) [HIR26-](#)
[21C/L423/CT\(XY\)](#) [IR928-6C/F1\(6-1\)](#) [IR423C/L10/F393\(AMZ\)\(PF\)](#) [EAISV3027A0](#) [HIR26-81B/L423/2T](#) [IR908-7C\(E5\)](#) [IR204-A-L\(BY\)\(M\)](#)
[IR333C-A\(BY\)\(Q\)](#) [IR928-6C\(X8-X12\)\(XBY\)](#) [IR968-8C\(6-2\)](#) [IR204C-A-L\(BY\)\(M\)](#) [IR968-8C\(6-1\)](#) [XYC-HIR76C-LX0](#) [XYC-IRA3020A65-](#)
[SX4](#) [XYC-HIR76C-LX4](#) [XYC-IRA3020A65-SX1](#) [DY-IRS302320C/6.5T](#) [DY-PTS3020268B-6.5TC](#) [DY-IR-8S302320C-6.5T](#) [DY-IR928-6C](#)
[XL-504IRC-940](#) [XL-SD3036HIR-T202](#) [IR12-21C/TR8\(PF\)](#) [NCD3012I1](#) [NCD1005I1](#) [XYC-IR26C-LX4](#) [XYC-IR204C-L4](#) [XYC-IRC18C-24](#)
[XYC-IR76C30-LX4](#) [XYC-IRA0805AC-S4](#) [XYC-HIRWC18C-Z2](#) [XYC-IRP0603AC-A2](#) [XYC-IRA2835A90-X4](#)